

Monitor Service Manual

Model: VG32WQ3B

Version no. V00

Release date: Oct.31, 2024

COPYRIGHT INFORMATION

No part of this manual, including the products and software described in it, may be reproduced, transmitted, transcribed, stored in a retrieval system, or translated into any language in any form or by any means, except documentation kept by the purchaser for backup purposes, without the express written permission of ASUSTeK COMPUTER INC. ("ASUS").

ASUS PROVIDES THIS MANUAL "AS IS" WITHOUT WARRANTY OF ANY KIND, EITHER EXPRESS OR IMPLIED, INCLUDING BUT NOT LIMITED TO THE IMPLIED WARRANTIES OR CONDITIONS OF MERCHANTABILITY OR FITNESS FOR A PARTICULAR PURPOSE. IN NO EVENT SHALL ASUS, ITS DIRECTORS, OFFICERS, EMPLOYEES OR AGENTS BE LIABLE FOR ANY INDIRECT, SPECIAL, INCIDENTAL, OR CONSEQUENTIAL DAMAGES (INCLUDING DAMAGES FOR LOSS OF PROFITS, LOSS OF BUSINESS, LOSS OF USE OR DATA, INTERRUPTION OF BUSINESS AND THE LIKE), EVEN IF ASUS HAS BEEN ADVISED OF THE POSSIBILITY OF SUCH DAMAGES ARISING FROM ANY DEFECT OR ERROR IN THIS MANUAL OR PRODUCT.

Products and corporate names appearing in this manual may or may not be registered trademarks or copyrights of their respective companies, and are used only for identification or explanation and to the owners' benefit, without intent to infringe.

SPECIFICATIONS AND INFORMATION CONTAINED IN THIS MANUAL ARE FURNISHED FOR INFORMATIONAL USE ONLY, AND ARE SUBJECT TO CHANGE AT ANY TIME WITHOUT NOTICE, AND SHOULD NOT BE CONSTRUED AS A COMMITMENT BY ASUS. ASUS ASSUMES NO RESPONSIBILITY OR LIABILITY FOR ANY ERRORS OR INACCURACIES THAT MAY APPEAR IN THIS MANUAL, INCLUDING THE PRODUCTS AND SOFTWARE DESCRIBED IN IT.

Copyright © 2024 ASUSTeK COMPUTER INC. All Rights Reserved.

LIMITATION OF LIABILITY

Circumstances may arise where because of a default on ASUS' part or other liability, you are entitled to recover damages from ASUS. In each such instance, regardless of the basis on which you are entitled to claim damages from ASUS, ASUS is liable for no more than damages for bodily injury (including death) and damage to real property and tangible personal property; or any other actual and direct damages resulted from omission or failure of performing legal duties under this Warranty Statement, up to the listed contract price of each product.

ASUS will only be responsible for or indemnify you for loss, damages or claims based in contract, tort or infringement under this Warranty Statement.

This limit also applies to ASUS' suppliers and its reseller. It is the maximum for which ASUS, its suppliers, and your reseller are collectively responsible.

UNDER NO CIRCUMSTANCES IS ASUS LIABLE FOR ANY OF THE FOLLOWING: (1) THIRD-PARTY CLAIMS AGAINST YOU FOR DAMAGES; (2) LOSS OF, OR DAMAGE TO, YOUR RECORDS OR DATA; OR (3) SPECIAL, INCIDENTAL, OR INDIRECT DAMAGES OR FOR ANY ECONOMIC CONSEQUENTIAL DAMAGES (INCLUDING LOST PROFITS OR SAVINGS), EVEN IF ASUS, ITS SUPPLIERS OR YOUR RESELLER IS INFORMED OF THEIR POSSIBILITY.

SERVICE AND SUPPORT

Visit our multi-language website at <https://www.asus.com/support/>

Table of Contents

1. Safety Precautions.....	4
2. Exploded View	5
3. Disassembly & Assembly SOP.....	7
4. Trouble shooting	23

1. Safety Precautions

Safety information

- Before setting up the monitor, carefully read all the documentation that came with the package.
- To prevent fire or shock hazard, never expose the monitor to rain or moisture.
- Never try to open the monitor cabinet. The dangerous high voltages inside the monitor may result in serious physical injury.
- If the power supply is broken, do not try to fix it by yourself. Contact a qualified service technician or your retailer.
- Before using the product, make sure all cables are correctly connected and the power cables are not damaged. If you detect any damage, contact your dealer immediately.
- Slots and openings on the back or top of the cabinet are provided for ventilation. Do not block these slots. Never place this product near or over a radiator or heat source unless proper ventilation is provided.
- The monitor should be operated only from the type of power source indicated on the label. If you are not sure of the type of power supply to your home, consult your dealer or local power company.
- Use the appropriate power plug which complies with your local power standard.
- Do not overload power strips and extension cords. Overloading can result in fire or electric shock.
- Avoid dust, humidity, and temperature extremes. Do not place the monitor in any area where it may become wet. Place the monitor on a stable surface.
- Unplug the unit during a lightning storm or if it will not be used for a long period of time. This will protect the monitor from damage due to power surges.
- Never push objects or spill liquid of any kind into the slots on the monitor cabinet.
- To ensure satisfactory operation, use the monitor only with UL listed computers which have appropriate configured receptacles marked between 100-240V AC.
- If you encounter technical problems with the monitor, contact a qualified service technician or your retailer.

Care & Cleaning

- Before you lift or reposition your monitor, it is better to disconnect the cables and power cord. Follow the correct lifting techniques when positioning the monitor. When lifting or carrying the monitor, grasp the edges of the monitor. Do not lift the display by the stand or the cord.
- Cleaning. Turn your monitor off and unplug the power cord. Clean the monitor surface with a lint-free, non-abrasive cloth. Stubborn stains may be removed with a cloth dampened with mild cleaner.
- Avoid using a cleaner containing alcohol or acetone. Use a cleaner intended for use with the LCD. Never spray cleaner directly on the screen, as it may drip inside the monitor and cause an electric shock.

The following symptoms are normal with the monitor

- The screen may flicker during the initial use due to the nature of the fluorescent light. Turn off the Power Switch and turn it on again to make sure that the flicker disappears.
- You may find slightly uneven brightness on the screen depending on the desktop pattern you use.
- When the same image is display for hours, an afterimage of the previous screen may remain after switching the image. The screen will recover slowly or you can turn off the Power Switch for hours.
- When the screen becomes black or flashes, or cannot work anymore, contact your dealer or service center to fix it. Do not repair the screen by yourself!

2. Exploded View

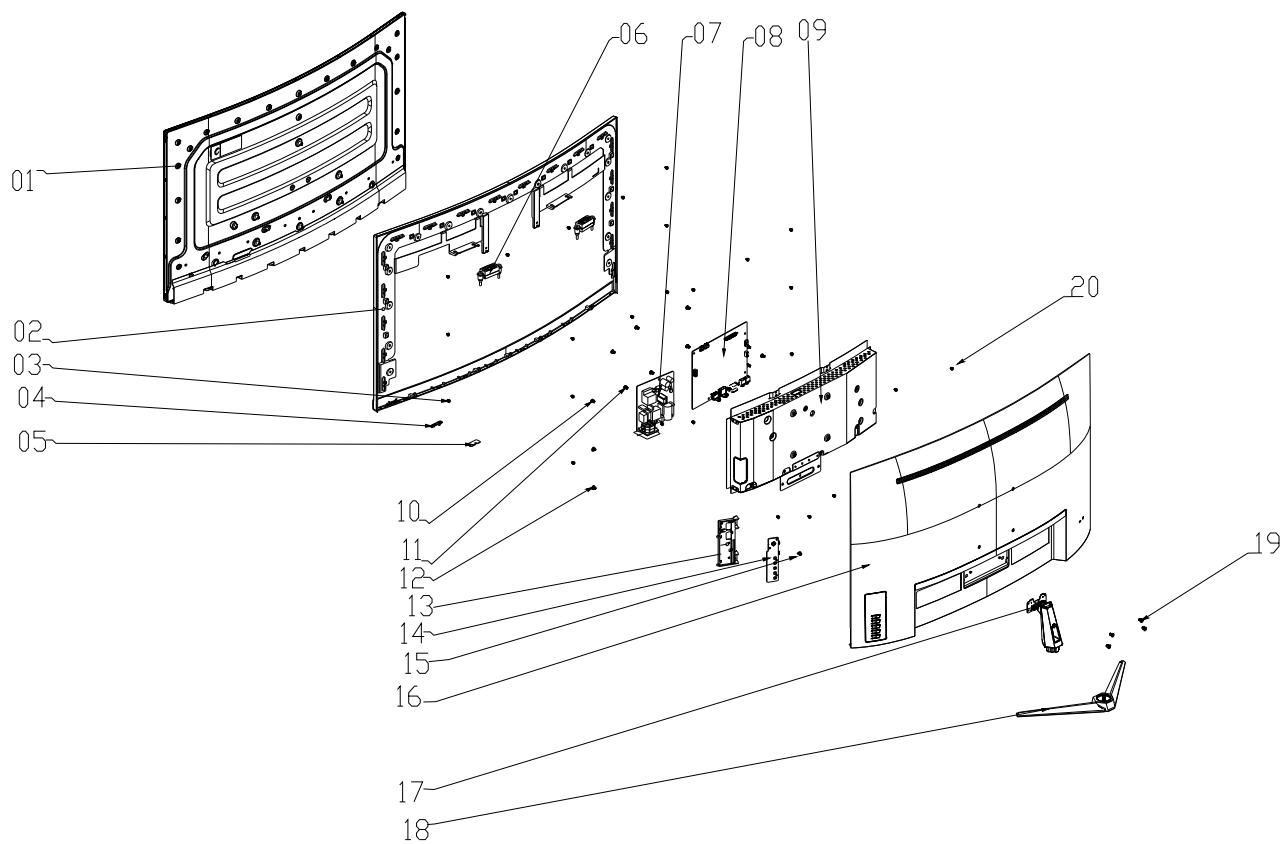



No.	ASUS Description
1	Panel
2	MIDDLE FRAME
3	MAINFRAME SCREW
4	LENS_POWER
5	LED BOARD
6	SPEAKER
7	POWER BOARD
8	MAIN BOARD
9	MAINFRAME
10	SCREW M4 6
11	SCREW D3 6
12	SCREW Q3 5
13	KEY_FRAME
14	KEY BOARD
15	KEY FUNCTION
16	REAR COVER
17	STAND
18	BASE_NA
19	SCREW M4 8
20	SCREW Q3 4

3. Disassembly & Assembly SOP





3.1. Precaution

Please read the precautions as follows to prevent any damages to the LCD Monitor.
Make sure all power connection is removed. Be sure that the LCD Monitor is in power off status.

<p>Prepare soft cloth and sponge as working platform to place LCD monitor horizontally.</p>	
<p>Hold LCD by the side carefully and DON'T touch or press panel directly.</p>	

3.2. Appropriate tools

Please according to different screw specifications choose different screwdrivers and heads.
The below photos are for reference only.

<p>Screwdriver</p>	
<p>Screwdriver</p>	
<p>HEX header screwdriver</p>	
<p>Screwdriver</p>	
<p>Disassembly tool</p>	

3.3. Disassembly Procedure

Information in this section is to perform the disassembly procedure of the LCD monitor. Depending on the failures, replace the defective parts accordingly.

ASUS VG32WQ3B LCD monitor consists of various subsystems. This section describes the procedures for LCD monitor disassembly. In addition, the detailed disassembly procedures of individual subsystem will be provided for your service needs.

The disassembly procedure consists of the following steps:

3.3.1 Stand Subsystem

3.3.2 Main Subsystem

3.3.3 Panel

3.3.1 Stand Subsystem

1. Release the screws to remove the stand & base ass'y.

Description	Q'ty	Screw Torque	Picture &Spec
Screw(Panel/ Stand_base ass'y)	4	12±1kgf.cm	





M6*20

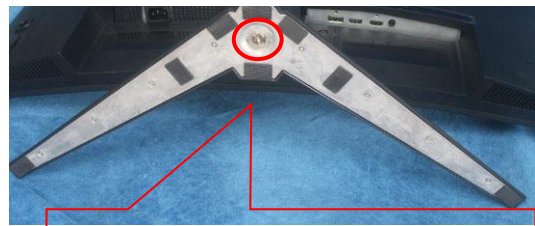

Customer-designated STAND-BASE ASSY. This screw is preassembled. There is no TPV PN.



4.3.2 Main Subsystem

1. Use disassembly tool to open all the latches along the edge of the Rear Cover. (Note: Start to open the latches from bottom. Please operate in sequence as below until separate the panel from rear cover. Don't damage the key board.)

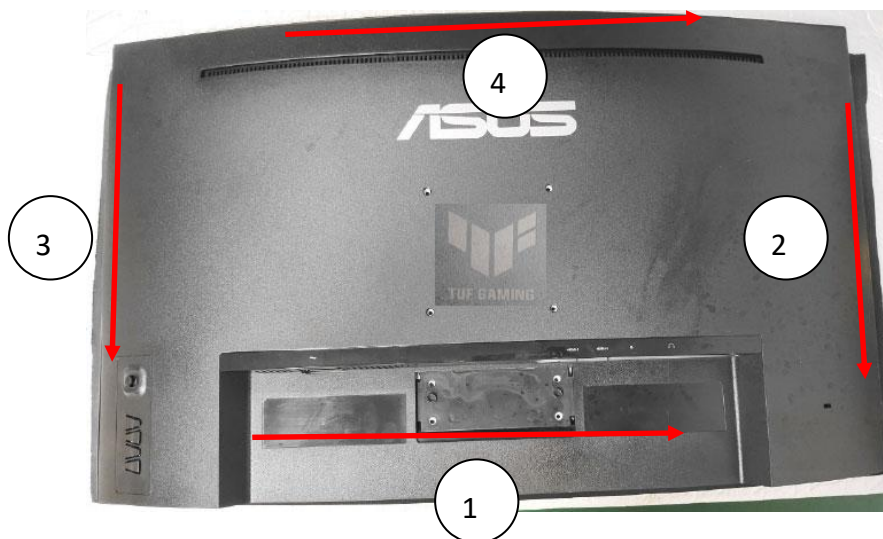

2. Gently open the rear cover and remove the LED board. Tear off the tape and disconnect the pin to remove the rear cover.

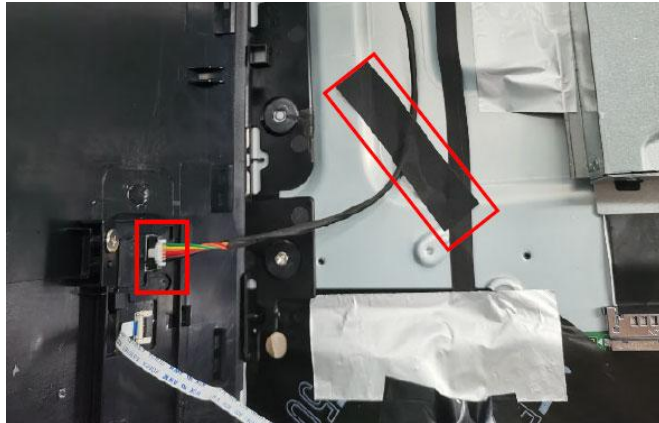
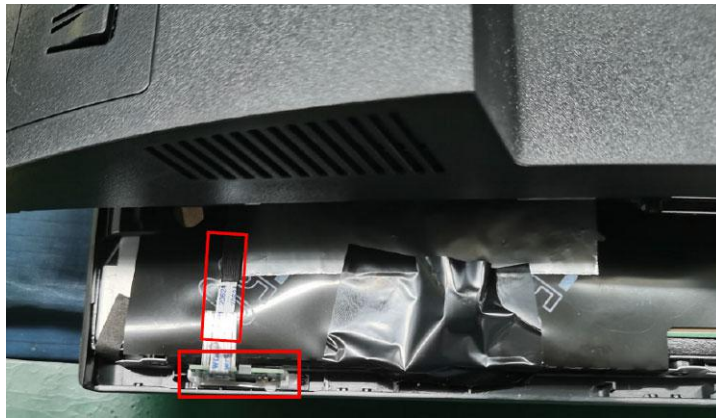

Key board & LED board

1. Disconnect the pin to remove the LED board.

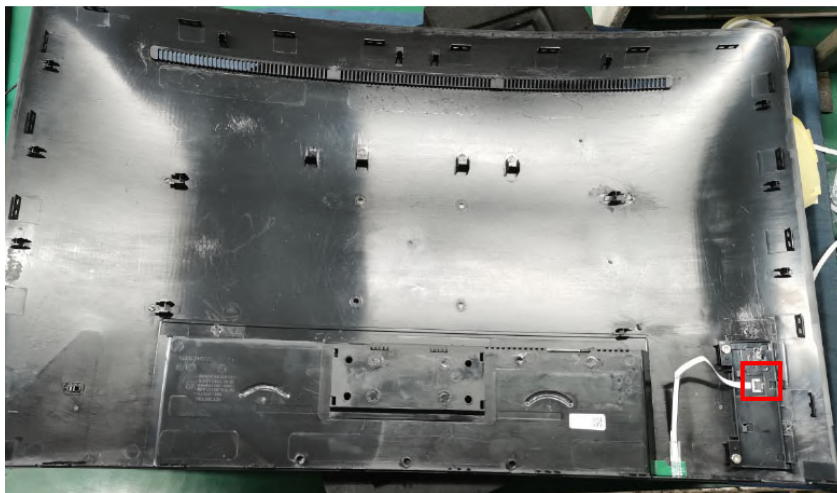

2. Release the screws to remove the key board from the rear cover.

Description	Q'ty	Screw Torque	Picture &Spec
Screw(Rear cover/key board)	2	4±1kgf.cm	



MAIN_FRAME & Speake

1. Tear off the tapes. Disconnect the pins. Remove the speakers.

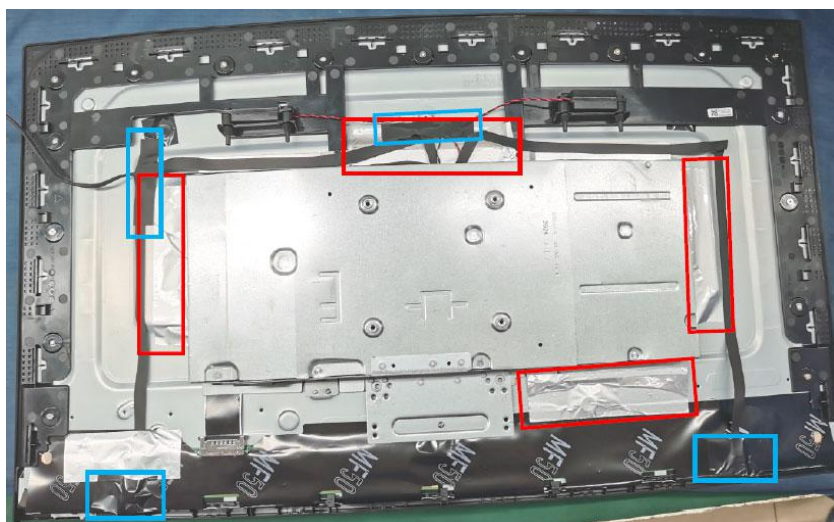

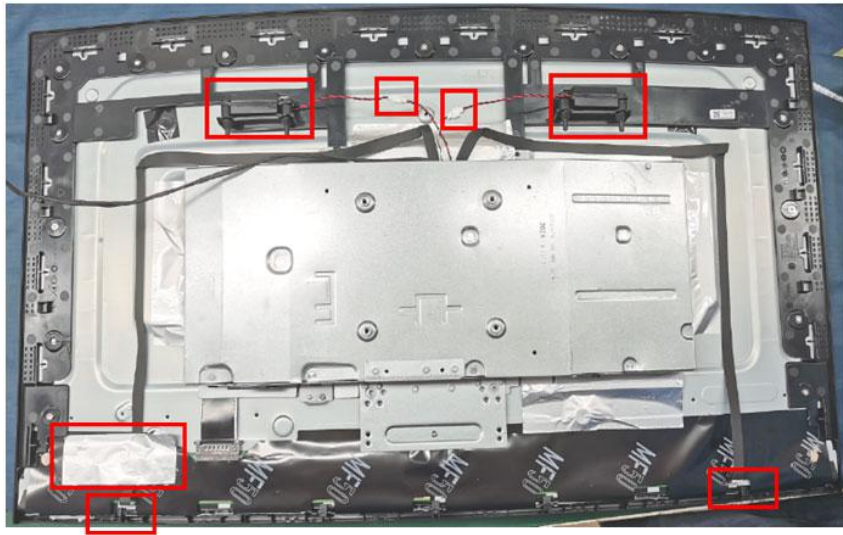

2. Release the screws to remove the main frame.

Description	Q'ty	Screw Torque	Picture &Spec
Screw-blue(main frame/middle frame)	2	4±1kgf.cm	
Screw-red(main frame/panel)	3	4±1kgf.cm	

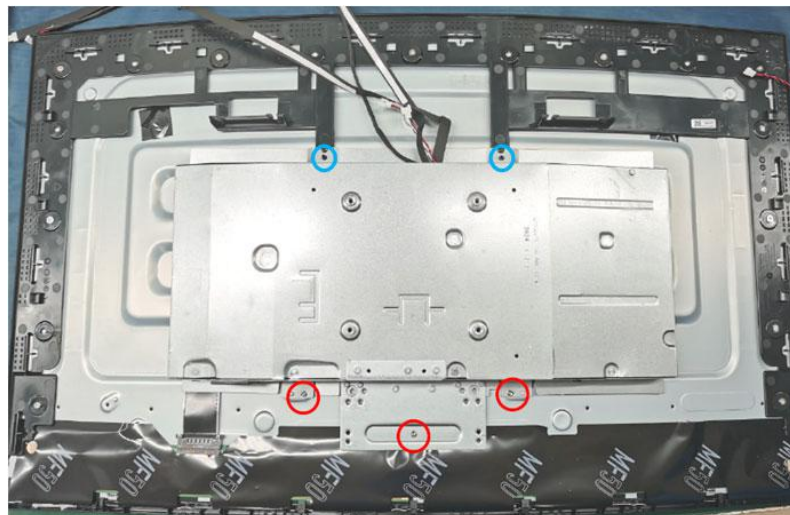

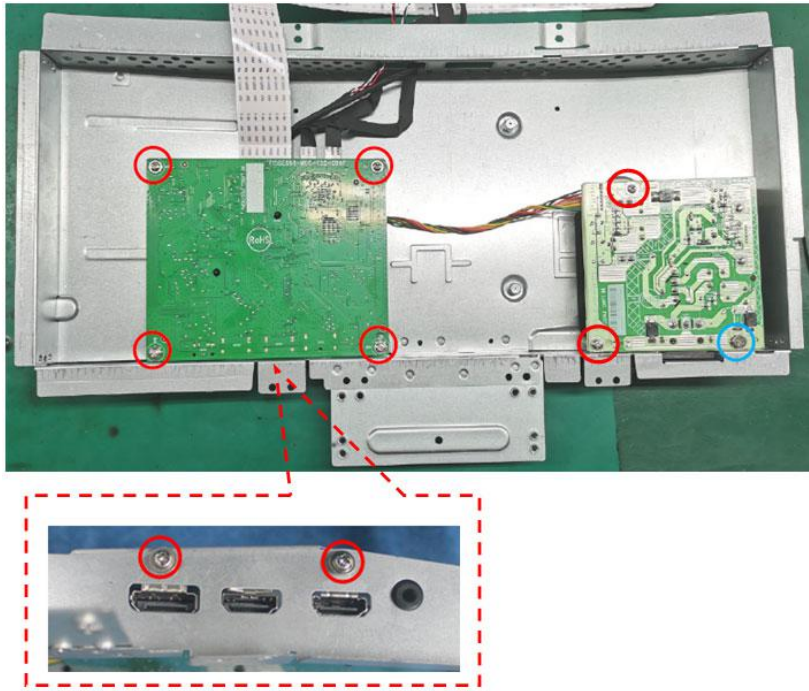

2. Take out the main board and power board. Disconnect all cables.

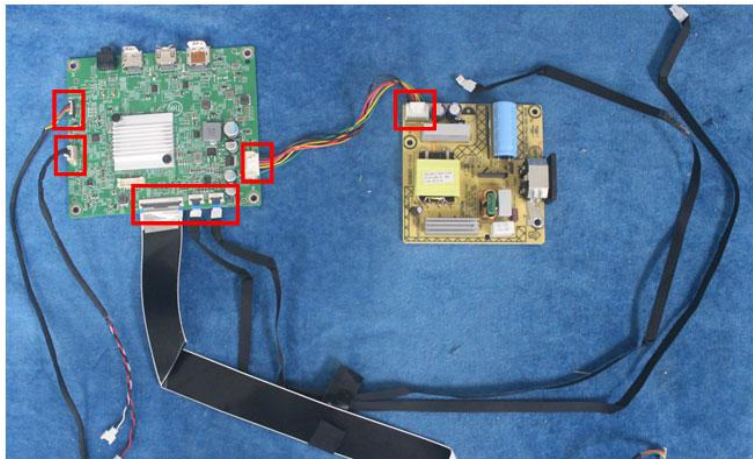

4.3.3 Panel

1. Release screws to separate the panel & the middle frame.

Description	Q'ty	Screw Torque	Picture & Spec
Screw-blue(middle frame/panel)	9	$4 \pm 0.5 \text{kgf.cm}$	

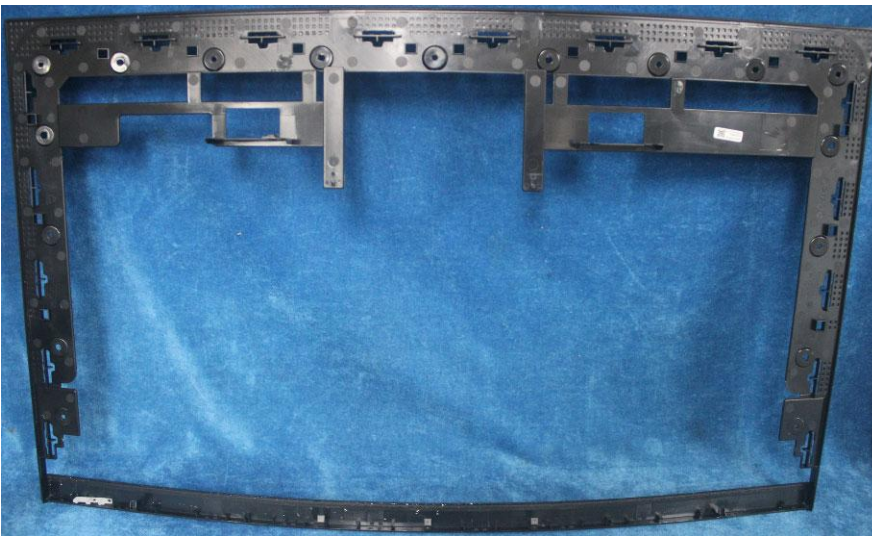

3.4 Assembly Procedure

3.4.1 Panel

1. Prepare the panel and middle frame. Use a screwdriver to tighten the screws.

Description	Q'ty	Screw Torque	Picture & Spec
Screw-red(middle frame/panel)	9	$4 \pm 0.5 \text{kgf.cm}$	

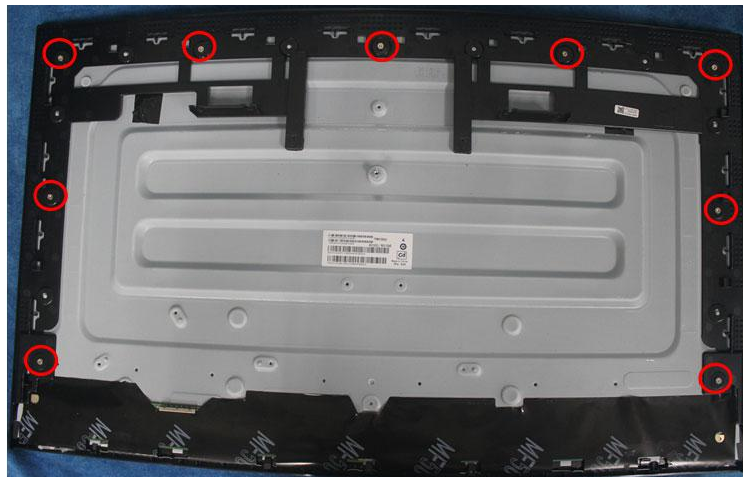
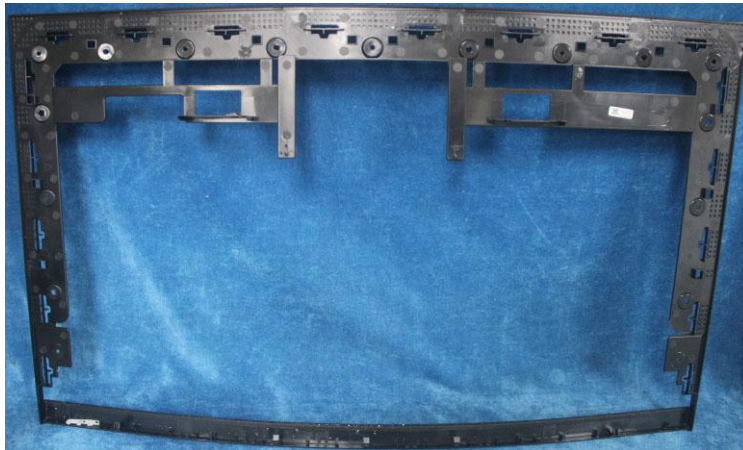

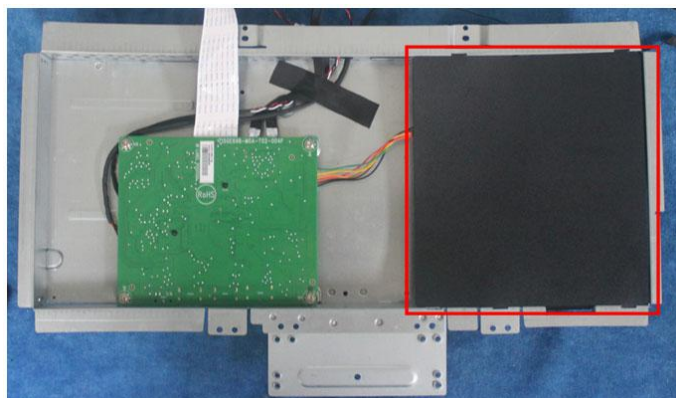

Main frame

1. Put the main frame on panel. Connect the pins and paste the tapes. Use screwdriver to tighten the screws.

Description	Q'ty	Screw Torque	Picture & Spec
Screw-blue(main frame/middle frame)	2	4±1kgf.cm	
Screw-red(main frame/panel)	3	4±1kgf.cm	

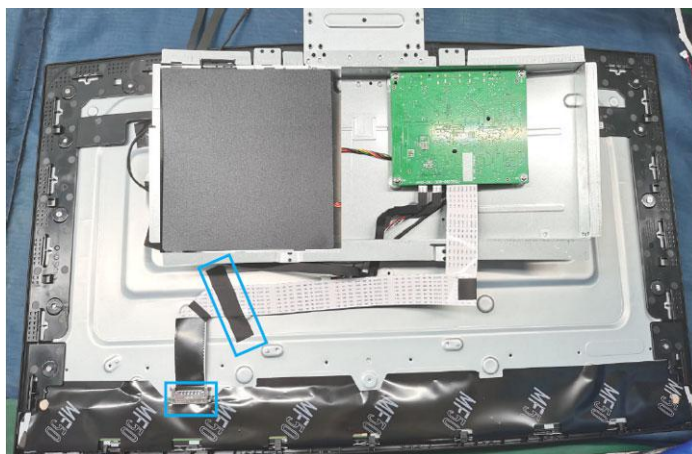

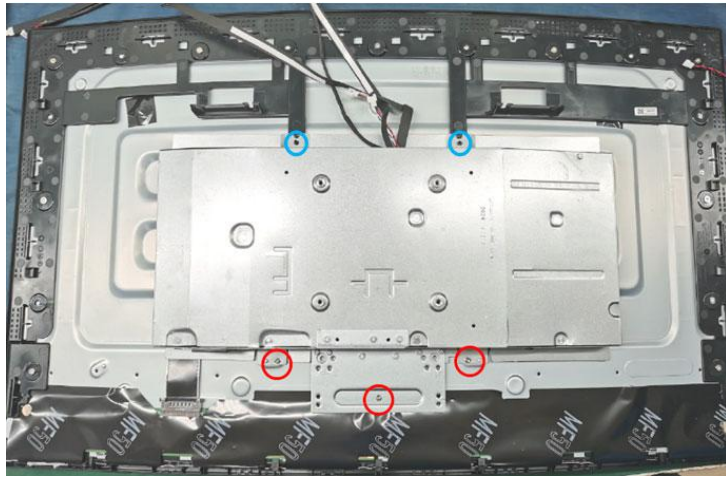

2. Connect the cable and assemble the speakers. Paste the tapes.

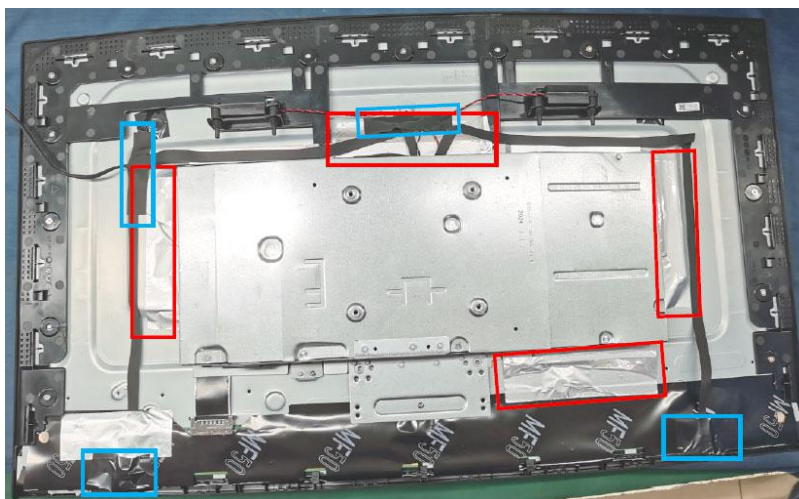
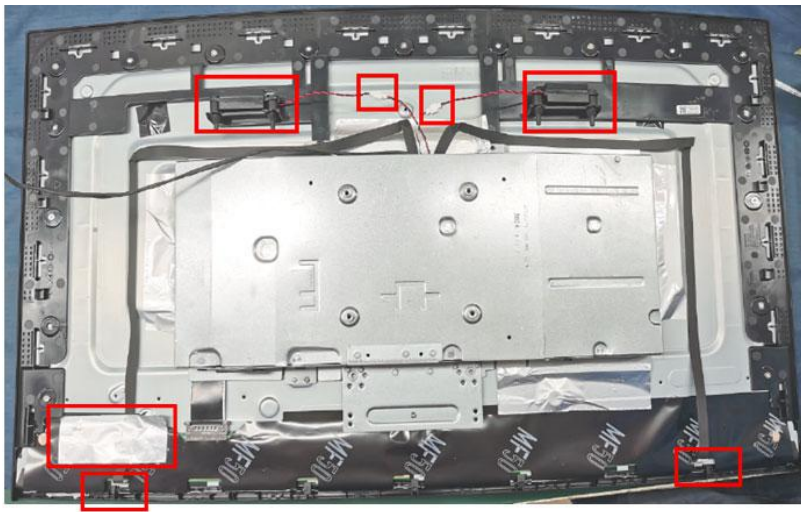

Key board & LED board

1. Assemble the key board.

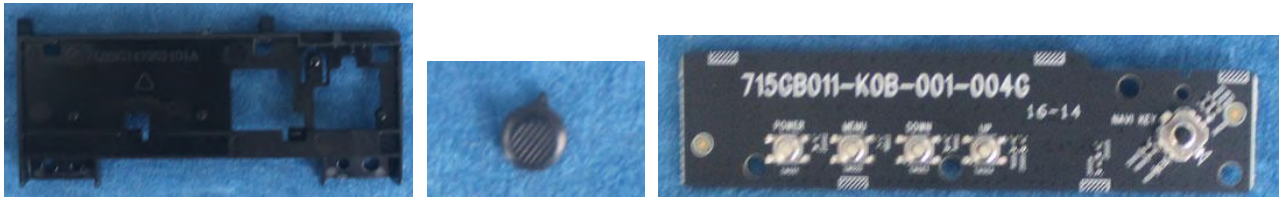

2. Assemble the LED board.

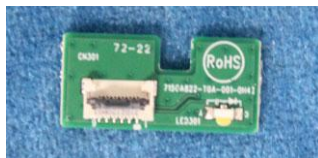

3. Use a screwdriver to tighten the key board to rear cover.

Description	Q'ty	Screw Torque	Picture & Spec
Screw(Rear cover/key board)	2	4±1kgf.cm	



Assemble the rear cover

Connect the pin of key board. Assemble the LED board to middle frame. And then assemble the rear cover.

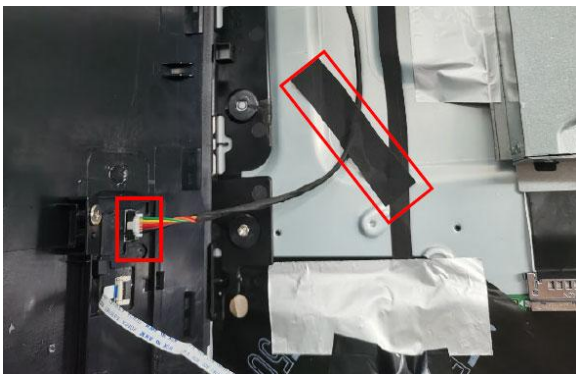

3.4.3 Stand Subsystem

Tighten the screw to assemble the stand ass'y and base ass'y. Assemble the stand-base ass'y to monitor. Use a screwdriver to tighten the screws.

Description	Q'ty	Screw Torque	Picture & Spec
Screw(Panel/ Stand_base ass'y)	4	12±1kgf.cm	

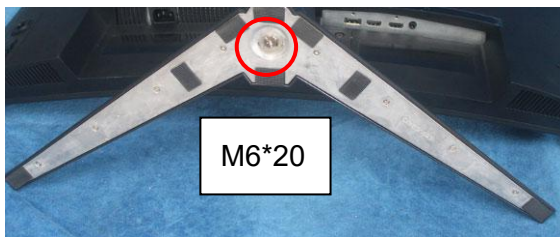

4. Trouble shooting

Problem	Possible Solution
Power LED is not ON	<ul style="list-style-type: none"> • Press the  button to check if the monitor is in the ON mode. • Check if the power cord is properly connected to the monitor and the power outlet. • Check Power Indicator function in main menu OSD. Select "ON" to turn on power LED.
The power LED lights amber and there is no screen image	<ul style="list-style-type: none"> • Check if the monitor and the computer are in the ON mode. • Make sure the signal cable is properly connected the monitor and the computer. • Inspect the signal cable and make sure none of the pins are bent. • Connect the computer with another available monitor to check if the computer is properly working.
Screen image is too light or dark	<ul style="list-style-type: none"> • Adjust the Contrast and Brightness settings via OSD.
Screen image bounces or a wave pattern is present in the image	<ul style="list-style-type: none"> • Make sure the signal cable is properly connected to the monitor and the computer. • Move electrical devices that may cause electrical interference.
Screen image has color defects (white does not look white)	<ul style="list-style-type: none"> • Inspect the signal cable and make sure that none of the pins are bent. • Perform Reset via OSD. • Adjust the R/G/B color settings or select the Color Temperature via OSD.
No sound or sound is low	<ul style="list-style-type: none"> • Adjust the volume settings of both your monitor and computer. • Make sure the computer sound card driver is properly installed and activated.