

SHARP®

MICROWAVE OVEN
OPERATION MANUAL

MODEL

SMC1169KS

CONTENTS



- Precautions to Avoid Possible Exposure to Excessive Microwave Energy 2
- For Customer Assistance 3
- Consumer Limited Warranty 4
- Product Information Card 4
- Important Safety Instructions 5
- Federal Communication Commission Radio Frequency Interference Statement 6
- Grounding Instructions 6
- Installation Guide 7
- Specifications 8
- Features Diagram 9-10
- Operation Procedure 11-14
- Controls 15-24
- Care of Your Microwave Oven 24-25
- Questions and Answers 26
- Cooking Instructions 27-36

READ ALL INSTRUCTIONS CAREFULLY BEFORE USING THE OVEN.

※ Keep the waveguide cover clean at all times.
Wipe the oven interior with a soft damp cloth after each use.
If you leave grease or fat anywhere in the cavity it may overheat, smoke or even catch fire when next using the oven.

PRECAUTIONS TO AVOID POSSIBLE EXPOSURE TO EXCESSIVE MICROWAVE ENERGY

- (a) Do not attempt to operate this oven with the door open since open-door operation can result in harmful exposure to microwave energy. It is important not to defeat or tamper with the safety interlocks.
- (b) Do not place any object between the oven front face and the door or allow soil or cleaner residue to accumulate on sealing surfaces.
- (c) Do not operate the oven if it is damaged. It is particularly important that the oven door close properly and that there is no damage to the: (1) door (bent), (2) hinges and latches (broken or loosened), (3) door seals and sealing surfaces.
- (d) The oven should not be adjusted or repaired by anyone except properly qualified service personnel.

REGISTER YOUR PRODUCT

Registering your new product is easy and offers benefits that help you get the most out of your Sharp product including:

- ✓ **Convenience:** If you ever need warranty support, your product information is already on file.
- ✓ **Communication:** Stay up to date with important notifications and special offers from SHARP.
- ✓ **Support:** Quickly access support content including Owner's Manuals, FAQ's, How-to Videos, and much more.

3 EASY WAYS TO REGISTER TODAY!

 <p>SCAN Use the camera or QR code scanning application on your mobile device</p>	 <p>ONLINE Visit our sites to learn more about your product at sharpusa.com and sbl.sharpusa.com</p>	 <p>CALL US US 800-BE-SHARP 800-237-4277 Mon-Fri: 7am-7pm CST Sat-Sun: 9am-7pm CST</p>
Scan this QR Code on your mobile device	Visit http://www.sharpusa.com/register	Contact a Sharp Advisor on the phone

PRODUCT SUPPORT

If you have questions about the setup or operation of your product, please refer to the corresponding section within this manual.



Additionally, visit www.sharpusa.com/support to access exclusive content about your product including:

- FAQ's and How-To Videos
- Find or Request Service
- Extended Warranty Options
- Downloads including the Installation Guide, Spec Sheet, and Owner's Manual
- For more information on the Child-Resistant Door Feature, please scan the below QR code or visit <https://delivr.com/25tnt-qr>



CONTACT US

If at any time you have questions or comments concerning your SHARP product, please contact the SHARP Customer Assistance Center. We are available to assist you through multiple contact methods for your convenience:

 <p>EMAIL Available 24/7 US: sharpusa.com</p>	 <p>CHAT ONLINE Mon-Fri: 7am-7pm CST Sat-Sun: 9am-7pm CST</p>	 <p>CALL US US 800-BE-SHARP 800-237-4277 Mon-Fri: 7am-7pm CST Sat-Sun: 9am-7pm CST</p>
See the Contact Us section on our sites	U.S. www.sharpusa.com/support	Contact a Sharp Advisor on the phone

CONSUMER LIMITED WARRANTY

SHARP ELECTRONICS CORPORATION warrants to the first consumer purchaser that this Sharp brand product (the "Product"), when shipped in its original container, will be free from defective workmanship and materials, and agrees that it will, at its option, either repair the defect or replace the defective Product or part thereof with a new or remanufactured equivalent at no charge to the purchaser for parts or labor for the period(s) set forth below.

This warranty does not apply to any appearance items of the Product nor to the additional excluded item(s) set forth below nor to any Product the exterior of which has been damaged or defaced, which has been subjected to improper voltage or other misuse, abnormal service or handling, or which has been altered or modified in design or construction.

In order to enforce the rights under this limited warranty, the purchaser should follow the steps set forth below and provide proof of purchase to the servicer.

The limited warranty described herein is in addition to whatever implied warranties may be granted to purchasers by law. ALL IMPLIED WARRANTIES INCLUDING THE WARRANTIES OF MERCHANTABILITY AND FITNESS FOR USE ARE LIMITED TO THE PERIOD(S) FROM THE DATE OF PURCHASE SET FORTH BELOW. Some states do not allow limitations on how long an implied warranty lasts, so the above limitation may not apply to you.

Neither the sales personnel of the seller nor any other person is authorized to make any warranties other than those described herein, or to extend the duration of any warranties beyond the time period described herein on behalf of Sharp.

The warranties described herein shall be the sole and exclusive warranties granted by Sharp and shall be the sole and exclusive remedy available to the purchaser. Correction of defects, in the manner and for the period of time described herein, shall constitute complete fulfillment of all liabilities and responsibilities of Sharp to the purchaser with respect to the Product, and shall constitute full satisfaction of all claims, whether based on contract, negligence, strict liability or otherwise. In no event shall Sharp be liable, or in any way responsible, for any damages or defects in the Product which were caused by repairs or attempted repairs performed by anyone other than an authorized servicer. Nor shall Sharp be liable or in any way responsible for any incidental or consequential economic or property damage. Some states do not allow the exclusion of incidental or consequential damages, so the above exclusion may not apply to you.

THIS LIMITED WARRANTY IS VALID ONLY IN THE FIFTY (50) UNITED STATES, THE DISTRICT OF COLUMBIA, AND PUERTO RICO.

Your Product Model Number & Description:

SMC1169KS Home Use Carousel Microwave Oven.
(Be sure to have this information available when you need service for your Product.)

Warranty Period for this Product:

One (1) year parts and labor. The warranty period continues for an additional four (4) years, for a total of five (5) years, with respect to the magnetron tube in the Product for parts only; labor and service are not provided free of charge for this additional period.

Additional Item(s) Excluded from Warranty Coverage (if any):

Non-functional accessories, turntable and light bulb.

Where to Obtain Service:

From a Sharp Authorized Servicer located in the United States. To find the location of the nearest Sharp Authorized Servicer, call Sharp toll free at 1-800-BE-SHARP (1-800-237-4277).

What to do to Obtain Service:

Ship prepaid or carry in your Product to a Sharp Authorized Servicer. Be sure to have Proof of Purchase available. If you ship the Product, be sure it is insured and packaged securely.

TO OBTAIN SUPPLY, ACCESSORY OR PRODUCT INFORMATION, CALL 1-800-BE-SHARP OR VISIT www.sharppusa.com. SAVE THE PROOF OF PURCHASE AS IT IS NEEDED SHOULD YOUR OVEN EVER REQUIRE WARRANTY SERVICE.

IMPORTANT SAFETY INSTRUCTIONS

When using electrical appliances, basic safety precautions should be followed, including the following:

WARNING-To reduce the risk of burns, electric shock, fire, injury to persons or exposure to excessive microwave energy:

1. Read all instructions before using the appliance.
2. Read and follow the specific "PRECAUTIONS TO AVOID POSSIBLE EXPOSURE TO EXCESSIVE MICROWAVE ENERGY" found on page 2.
3. This appliance must be grounded. Connect only to properly grounded outlet. See "GROUNDING INSTRUCTIONS" found on page 6.
4. Install or locate this appliance only in accordance with the provided installation instructions.
5. Some products such as whole eggs and sealed containers - for example, closed glass jars are able to explode and should not be heated in this oven.
6. Use this appliance only for its intended use as described in this manual. Do not use corrosive chemicals or vapors in this appliance. This type of oven is specifically designed to heat, cook, or dry food. It is not designed for industrial or laboratory use.
7. **HOT CONTENTS CAN CAUSE SEVERE BURNS. DO NOT ALLOW CHILDREN TO USE THE MICROWAVE.** Use with caution when removing hot items.
8. Do not operate this appliance if it has a damaged cord or plug, if it is not working properly, or if it has been damaged or dropped.
9. This appliance should be serviced only by qualified service personnel.
Contact nearest authorized service facility for examination, repair or adjustment.
10. Do not cover or block any openings on the appliance.
11. Do not store this appliance outdoors. Do not use this product near water — for example, near a kitchen sink, in a wet basement, near a swimming pool, or similar locations.
12. Do not immerse cord or plug in water.
13. Keep cord away from heated surfaces.
14. Do not let cord hang over edge of table or counter.
15. Separate cleaning instructions are provided. See door surface cleaning instructions on page 22.
16. To reduce the risk of fire in the oven cavity:
 - a) Do not overcook food. Carefully attend appliance when paper, plastic, or other combustible materials are placed inside the oven to facilitate cooking.
 - b) Remove wire twist-ties from paper or plastic bags before placing bag in oven.
 - c) If materials inside the oven ignite, keep oven door closed, turn oven off, and disconnect the power cord, or shut off power at the fuse or circuit breaker panel.
 - d) Do not use the cavity for storage purposes. Do not leave paper products, cooking utensils, or food in the cavity when not in use.
17. Liquids, such as water, coffee, or tea are able to be overheated beyond the boiling point without appearing to be boiling due to surface tension of the liquid. Visible bubbling or boiling when the container is removed from the microwave oven is not always present. **THIS COULD RESULT IN VERY HOT LIQUIDS SUDDENLY BOILING OVER WHEN A SPOON OR OTHER UTENSIL IS INSERTED INTO THE LIQUID.**
To reduce the risk of injury to persons:
 - a) Do not overheat the liquid.
 - b) Stir the liquid both before and halfway through heating it.
 - c) Do not use straight-sided containers with narrow necks.
 - d) After heating, allow the container to stand in the microwave oven for a short time before removing the container.
 - e) Use extreme care when inserting a spoon or other utensil into the container.
18. Do not use this microwave oven to heat corrosive chemicals (for example, sulfides and chlorides). Vapors from such corrosive chemicals may interact with the contact and springs of the safety interlock switches thereby rendering them inoperable.
19. Keep the waveguide cover clean at all times. Wipe the oven interior with a soft damp cloth after each use. If you leave grease or fat anywhere in the cavity it may overheat, smoke or even catch fire when next using the oven.
20. Never heat oil or fat for deep frying as you cannot control the temperature and doing so may lead to overheating and fire.
21. Do not operate the oven without the glass tray in place. Be sure it is properly sitting on the rotating base.

SAVE THESE INSTRUCTIONS

FEDERAL COMMUNICATIONS COMMISSION RADIO FREQUENCY INTERFERENCE STATEMENT

WARNING:

This equipment generates and uses ISM frequency energy and if not installed and used properly, that is in strict accordance with the manufacturer's instructions, may cause interference to radio and television reception.

It has been type-tested and found to comply with limits for an ISM Equipment pursuant to part 18 of FCC Rules, which are designed to provide reasonable protection against such interference in a residential installation.

However, there is no guarantee that interference will not occur in a particular installation.

If this equipment does cause interference to radio or television reception, which can be determined by turning the equipment off and on, the user is encouraged to try to correct the interference by one or more of the followings.

- Reorient the receiving antenna of radio or television.
- Relocate the Microwave oven with respect to the receiver.
- Move the microwave oven away from the receiver.
- Plug the microwave oven into a different outlet so that microwave oven and receiver are on different branch circuits.

THE MANUFACTURER is not responsible for any radio or TV interference caused by UNAUTHORIZED MODIFICATION to this microwave oven. It is the responsibility of the user to correct such interference.

GROUNDING INSTRUCTIONS

This appliance must be grounded. In the event of an electrical short circuit, the grounding plug reduces the risk of electric shock by providing an escape wire for electric current. This appliance is equipped with a cord having a grounding wire with a grounding plug. The plug must be plugged into an outlet that is properly installed and grounded.

WARNING:

Improper use of the grounding can result in a risk of electric shock.

Consult a qualified electrician or serviceman if the grounding instructions are not completely understood, or if doubt exists as to whether the appliance is properly grounded.

- If it is necessary to use an extension cord, use only a 3-wire extension cord that has a 3-blade grounding plug, and a 3-slot receptacle that will accept the plug on the appliance. The marked rating of the extension cord shall be equal to or greater than the electrical rating of the appliance.

WARNING:

Do not cut or remove the third (ground) prong from the power cord under any circumstances.

INSTALLATION GUIDE

1. Examine the oven after unpacking.

Check for damage such as a misaligned door, broken door or dent in the cavity. If any damage is visible, DO NOT INSTALL, and notify your dealer immediately.

2. Level, flat location.

Install the microwave oven on a level, flat surface.

3. Ventilation.

Do not block air vents. If they are blocked during operation, the oven may overheat and eventually cause a failure. For proper ventilation, allow 4 inches of space between oven top, sides, rear and adjacent surfaces.

4. Away from radio and TV sets.

Poor television reception and radio interference may result if the oven is located close to a TV, radio, antenna, feeder, etc. Place the oven as far from them as possible.

5. Away from heating appliances and water taps.

Keep the oven away from heat, steam or splashing liquids. These things can adversely affect oven wiring and contacts.

6. Power supply.

- Check your local power source.

This microwave oven requires a current of approximately 14 amperes, 120Volts, 60Hz and a grounded outlet.

1. A short power-supply cord is provided to reduce the risks of the user becoming entangled in or tripping over a longer cord.

2. Longer cord sets or extension cords are available and may be used if care is exercised in their use.

3. If a long cord or extension cord is used:

- The marked electrical rating of the cord set or extension cord should be at least as great as the electrical rating of the oven.
- The extension cord must be a grounding type 3-wire cord.
- The longer cord should be arranged so that it will not drape the table top or counter where it can be pulled on by children or tripped over unintentionally.

7. The minimum height of free space necessary above the top surface of the oven is about 4 inches.

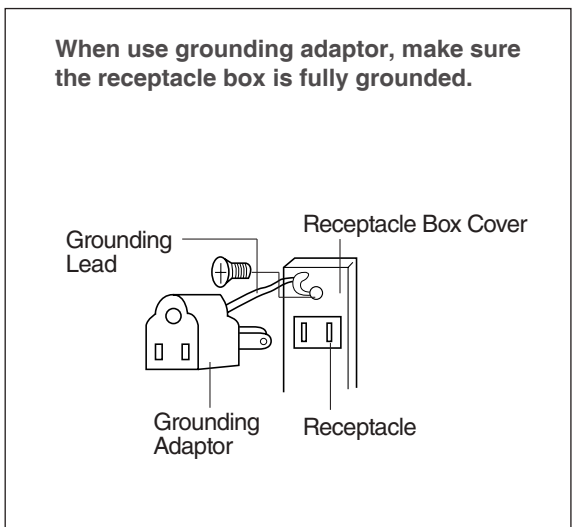
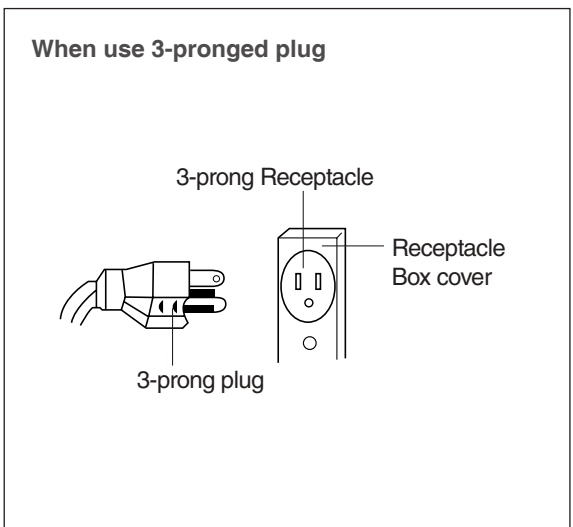

“THE CANADIAN ELECTRICAL CODE DOES NOT ALLOW THE USE OF THE GROUNDING ADAPTOR”

SPECIFICATIONS

POWER SUPPLY		120V AC, 60Hz SINGLE PHASE WITH GROUNDING
MICROWAVE	INPUT POWER	1600 W
	ENERGY OUTPUT	1000 W
	FREQUENCY	2,450MHz
OUTSIDE DIMENSIONS (W x D x H)		20.6 x 14.7 x 11.8 in.
CAVITY DIMENSIONS (W x D x H)		13.9 x 14.1 x 9.6 in.
CAVITY VOLUME		1.1 cu.ft
NET WEIGHT		APPROX. 31.1 lbs.
TIMER		99 min. 99 sec.
POWER SELECTIONS		11 Levels

* Specifications are subject to change without notice.

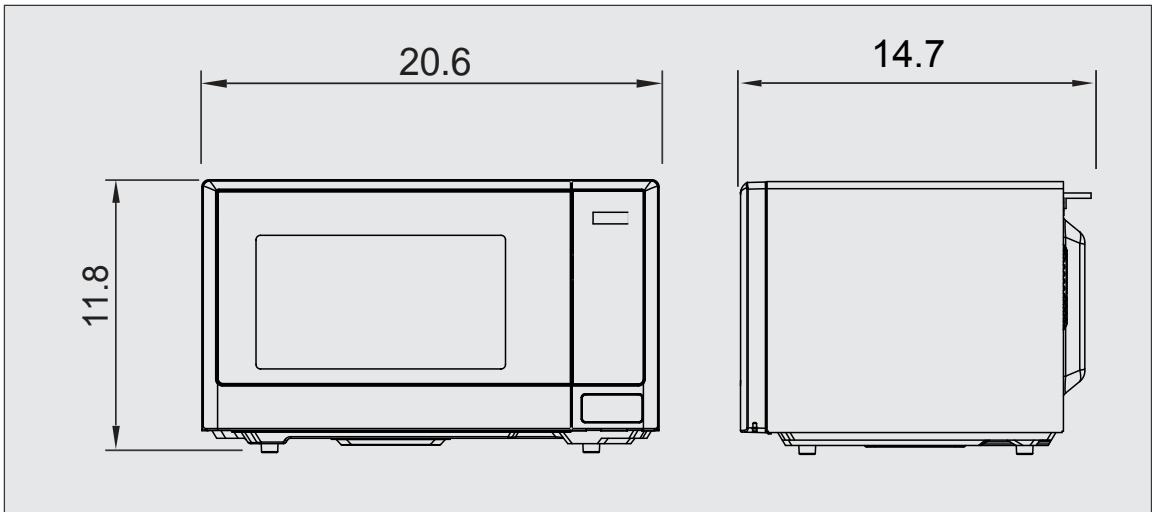



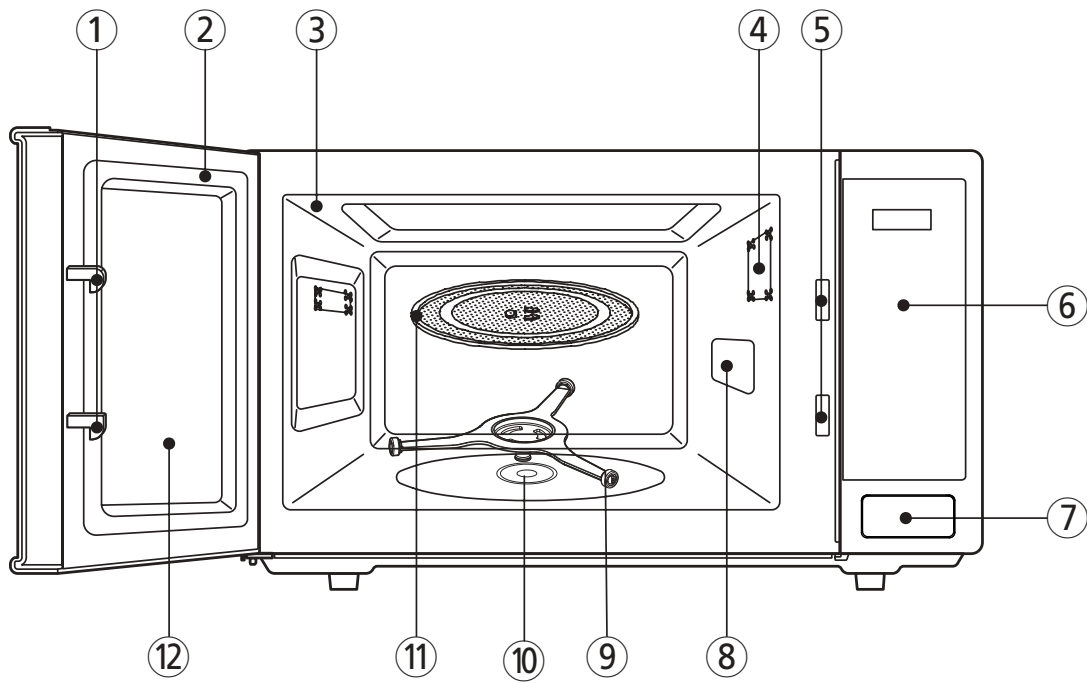





FEATURES DIAGRAM



- ① **Door latch** - When the door is closed, it will automatically shut off. If the door is opened while the oven is operating, the magnetron will automatically shut off.
- ② **Door seal** - The door seal surfaces prevent microwaves escaping from the oven cavity.
- ③ **Oven cavity**
- ④ **Oven light** -Automatically turns on when the oven door is open and operating.
- ⑤ **Safety interlock system**
- ⑥ **Control panel**
- ⑦ **Door open button** - To open the door push the door open button.
- ⑧ **Waveguide cover** - Protects the microwave outlet from splashes of cooking foods.
- ⑨ **Roller guide** - This must always be used for cooking together with the glass cooking tray.
- ⑩ **Coupler** - This fits over the shaft in the center of the oven cavity floor. This is to remain in the oven for all cooking.
- ⑪ **Glass cooking tray** - Made of special heat resistant glass. The tray must always be in proper position before operating. Do not cook food directly on the tray.
- ⑫ **Viewing screen** - Allows viewing of food. The screen is designed so that light can pass through, but not the microwave.

FEATURES DIAGRAM

- |  : MICROWAVE indicator
- |  : DEFROST indicator
- |  : HIGH POWER indicator
- |  : LOW POWER indicator
- |  : CLOCK indicator
- |  : LOCK indicator
- |  : AUTO MENU indicator
- |  : WEIGHT(Oz) indicator
- |  : WEIGHT(Lbs) indicator

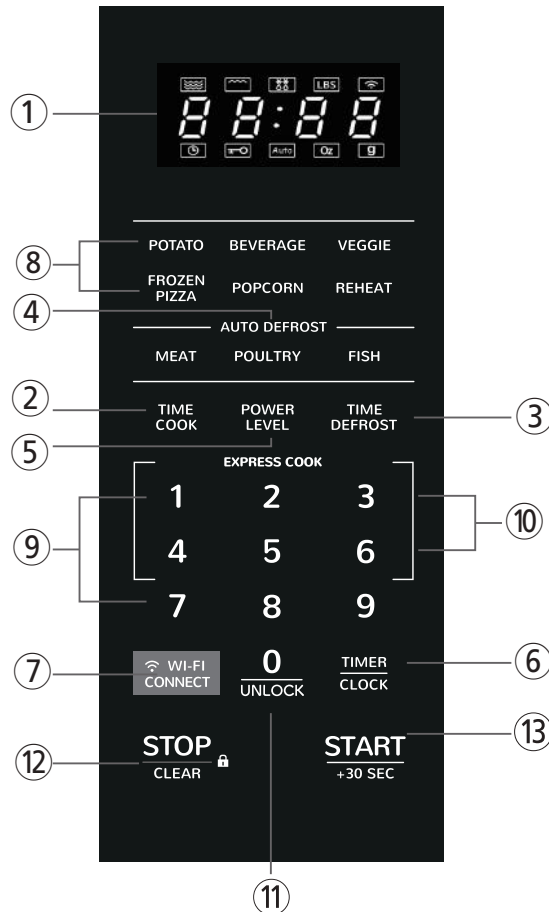

- ① **DISPLAY** - Cooking time, power level, indicators and current time are displayed.
- ② **TIME COOK** - Used to set the cooking according to the desired power and time.
- ③ **TIME DEFROST** - Used to defrost foods for time.
- ④ **AUTO DEFROST PAD** - Press to select DEFROST feature by weight.
- ⑤ **POWER LEVEL** - Used to set power level.
- ⑥ **TIMER / CLOCK** - Used to set the clock. Used as a minute timer, delay cooking, hold setting after cooking.
- ⑦ **WI-FI CONNECT** - Used to turn on or off your ovens WI-FI connection
- ⑧ **AUTO COOK MENU** - Used to select an Auto Cook program.
- ⑨ **NUMBER BUTTON** - Used to enter the cooking time, kitchen timer, etc.
- ⑩ **EXPRESS COOK** - Press one of the Express Cook pads (from 1-6) for 1-6 minutes of cooking at 100% (full power).
- ⑪ **0 / UNLOCK** - Used to open the door when Child-Resistant Door Lock feature is enabled.
- ⑫ **STOP / CLEAR** - Used to stop the oven operation or to delete the cooking data.
- ⑬ **START / +30 SEC** - Used to start the oven and also used to set a reheat time.

OPERATION PROCEDURE

This section includes useful information about oven operation.

- 1 Plug power supply cord into a standard 3-pronged 14 Amp, 120V AC 60Hz power outlet.
- 2 After placing the food in a suitable container, open the oven door and put it on the glass tray. The glass tray and roller guide must always be in place during cooking.
- 3 Close the door. Make sure that it is firmly closed.
- 4 The oven light is on when the microwave oven is operating.
- 5 The oven door can be opened at any time during operation by pushing the door open button of control panel. This will vary depending on if your microwave has the Child Resistant Door Lock enabled. See page 15. The oven will automatically shut off.
- 6 Each time a pad is touched, a BEEP will sound to acknowledge the touch.
- 7 The oven automatically cooks on full power unless set to a lower power level.
- 8 The display will show " 0:00 " when the oven is plugged in.
- 9 Time clock returns to the present time when the cooking time ends.
- 10 When the STOP/CLEAR pad is touched during the oven operation, the oven stops cooking and all information retained. To erase all information(except the present time), touch the STOP/CLEAR pad once more. If the oven door is opened during the oven operation, all information is retained.
- 11 If the START/+30 SEC pad is touched and the oven does not operate, check the area between the door and door seal for obstructions and make sure the door is closed securely. The oven will not start cooking until the door is completely closed or the program has been reset.

Make sure the oven is properly installed and plugged into the electrical outlet.

WATTAGE OUTPUT CHART

- The power level is set by setting a cooking time, then selecting Power Level, then press number keys to choose the power level needed. The chart shows the display, the power level and the percentage of power.

TOUCH THE NUMBER PAD	POWER LEVEL (DISPLAY)	APPROXIMATE PERCENTAGE OF POWER
10	PL10	100%
9	PL9	90%
8	PL8	80%
7	PL7	70%
6	PL6	60%
5	PL5	50%
4	PL4	40%
3	PL3	30%
2	PL2	20%
1	PL1	10%
0	PL0	0%

OPERATION PROCEDURE

SETTING UP ALEXA ON YOUR MICROWAVE OVEN

Your microwave oven can be controlled with Alexa using any Alexa-enabled device such as Echo or Echo Dot. To control your microwave oven using Alexa, you'll need to set up your microwave and connect to Alexa using one of the below pairing methods.

Pairing Method 1: Zero-Touch Setup (ZTS)

In order to pair using this method, **all** pre-requisites listed below must be met. If not, go to pairing method #2 or #3.

- ✓ You opted-in to store your Wi-Fi credentials to your Amazon account in the past. This occurs when you previously set up another Echo family device or a Works with Alexa device.
- ✓ The microwave must have been ordered from the same Amazon account and while ordering you must have opted to link the device upon purchase. If microwave was purchased/received as a gift, or user de-selected this option upon purchase, the microwave will not be linked to end user's Amazon/Alexa account and ZTS will not be enabled. Please go to pairing method #2 or #3.
- ✓ The microwave would need to be within the Wi-Fi range of the user's Wi-Fi network.
- ✓ The microwave should be within the wireless range of an Echo family device, which was signed into using the same Amazon account.

If above conditions are met:

1. Plug the microwave oven into a power outlet that is grounded.
2. Ensure that home Wi-Fi is on and the device is in setup mode.
3. If the Wi-Fi icon stops blinking and stays on steadily, the device is ready to be controlled by using Alexa. (If the Wi-Fi icon is off, press the Wi-Fi button once to turn the Wi-Fi on.)
4. Open Alexa app on your phone and sign into the same Amazon account as the one above. The Microwave should appear in the list of devices.

- **Setup mode** : While the device is in setup mode, the Wi-Fi icon is flashing until successfully paired. Setup mode is activated for 5 minutes. After 5 minutes, setup mode will time out.
- **Turning off the Wi-Fi on the device** : Used to turn on or off your device's Wi-Fi connection. If you turn the Wi-Fi off on the device by pressing the Wi-Fi CONNECT button, the Wi-Fi icon is off on the microwave LED display and Alexa will no longer be able to send commands to your oven. But you can still cook using the oven's keypad.

Pairing Method 2: Barcode Setup (BCS)

If Zero-Touch Setup (ZTS) is not possible, you can set up your microwave and connect to Alexa using Barcode Setup (BCS).

1. Install the latest version of Alexa app on your smart device and login with your Amazon account.
2. Plug the microwave oven into a power outlet that is grounded.
3. Ensure that home Wi-Fi is on.
4. When Wi-Fi icon starts flashing, the microwave oven is ready for setup. (If the Wi-Fi icon is off, reset the microwave oven by pressing Wi-Fi CONNECT button.)
5. Open the Alexa App, tap the Devices icon in the lower right, and tap the "+" icon in the top right. Select "Add Device" and "Microwave" press "Sharp" to begin set up for your microwave oven. Follow on-screen instructions.

OPERATION PROCEDURE

NOTE: The QR code used for microwave oven setup is attached inside the product. Please open the door and scan the QR code to the right of a key image on the front side of the product.

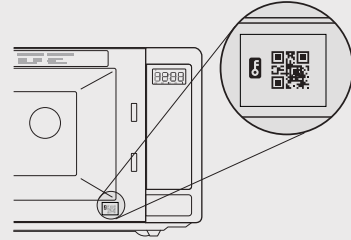

6. If the Wi-Fi icon stops blinking and is off after 5 minutes, reset the microwave oven by pressing Wi-Fi CONNECT button restart from the step 5.

Pairing Method 3: User Guided Setup (UGS)

If the QR code on the device is lost or has been damaged and you cannot use Pairing Method #2, you can set up your microwave and connect to Alexa using User Guided Setup (UGS).

1. Install the latest version of Alexa app on your smart device and login with your Amazon account.
2. Open the Alexa App, tap the Devices icon in the lower right, and tap the "+" icon in the top right. Select "Add Device" and "Microwave" press "Sharp" to begin set up for your microwave oven. Follow on-screen instructions.
3. When a screen with 2D Barcode appears, Press DON'T HAVE A BARCODE to continue setup.
4. And then, follow the on-screen instructions to set up your microwave oven.
 - a. Plug the microwave oven into a power outlet that is grounded.
 - b. Ensure that Home Wi-Fi is on.
 - c. Press WI-FI CONNECT button once, "Pair" **PAIR** will appear on the microwave LED display. The Wi-Fi icon will start blinking.
 - d. Press NEXT to continue setup.
5. If the Wi-Fi icon stops blinking and is off after 5 minutes, setup times out. Restart from the step 4.c.

After set up, the LED display will turn on the Wi-Fi icon and show local time in your location.

NOTE: It may take a few minutes for the LED display to show the correct local time.

Once set up is completed, it is automatically set up even after turning the power of the oven off and on.

NOTE: When you delete the product from the Alexa app, you must set up again.

OPERATION PROCEDURE

OPERATING YOUR MICROWAVE OVEN

You can use your oven without setting it up for Alexa control.

However, we highly recommend using your oven with Alexa control to unlock the full potential.

Throughout this section, the following icons indicate:



Instructions to operate the oven with voice.

NOTE: As a safety measure, the oven can only be commanded using voice within 10 minutes of the door being closed.

CONTROLS

CHILD-RESISTANT DOOR LOCK

This microwave oven is equipped with the Child-Resistant Door Lock feature as a UL safety requirement for all countertop microwave ovens sold in the United States. Follow the instructions below to learn about this feature!

The door lock is only prompted by a cooking action. The door will stay locked for the duration of the cooking time, plus 30 min after completion of the cooking operation. To open the door during this time:

- (1) Press "0/UNLOCK" first.
- (2) Press door button to open the door.



If user tries to open the door without pressing the "0/UNLOCK" button, "Door" will appear on the display as a reminder to unlock the door.



Note: The user must open the door within 10 seconds of pressing the "0/UNLOCK" Otherwise, the door lock will be reactivated.

DISABLE / ENABLE DOOR LOCK FEATURE

The Door Lock Feature can be disabled or re-enabled if you want. Please follow the instructions below.

To disable / re-enable this feature, press 7-9-0 (hold 0 button for 3 seconds).

- (1) Press "7" first
- (2) Next, press "9"
- (3) Press "0" and hold for 3 seconds.



Note: If display is off, press any button on the control panel to turn display on before attempting to disable/enable the Child-Resistant Door Lock Feature. (hold for 3 seconds)

When disabled, "OFF" will be displayed with an audible sound.



When re-enabled, "Door" will be displayed with an audible sound.



- Note: 1. Once disabled, this feature will remain disabled even after a power outage.
- 2. For more information, please scan the QR code or visit <https://delivr.com/25tnt-qr>





CONTROLS

SETTING THE CLOCK

When the oven is first plugged in, the display will show "0:00" and a tone will sound. If the AC power ever goes off, the display show " 0:00" when the power comes back on.

- (1) Press " CLOCK " "00:00" will display.
- (2) Press the number keys to program current time. For example, to set the clock to 10:12, press " 1,0,1,2" or to set the clock at 5:12, press "0,5,1,2".
- (3) Press "CLOCK" to finish clock setting. Note that the ":" will continuously flash while the clock is set.
- (4) If the numbers are not within the range of 1:00-12:59, the setting will be invalid until valid numbers are input.



Note:

1. In the process of clock setting, if the "STOP/CLEAR" button is pressed or if there is no operation selected within 5 minutes, the oven will go back to the previous setting automatically.
2. If the clock needs to be reset, repeat steps 1- 3.

KITCHEN TIMER MODE

Timer operates as a minute timer, can be set to delay cooking and used to set a holding time after cooking. However delay cooking cannot be programmed for defrost. Timer operates without microwave energy.



- (1) Press "KITCHEN TIMER " display will show "00:00".
- (2) Press the number keys and enter the timer time. (The maximum cooking time is 99 minutes and 99 seconds).
- (3) Press " START/+30SEC. " to confirm setting.
- (4) When the timer time arrives, the buzzer will beep 5 times. If the clock is set, the LED will display the current time.

Note: 1. The kitchen timer is a timer and will not display the "Clock."
2. When using the kitchen timer, no other program can be set.

The TIMER indicator starts blinking and the display counts down the time remaining in KITCHEN TIMER mode. When KITCHEN TIMER mode ends, you will hear 5 beeps.

CONTROLS

TIME COOK

"Alexa, microwave for X. "

To microwave by time, say "Alexa, microwave for X," where X is the amount of time you'd like to cook for. For example, to cook for 5 minutes, say "Alexa, microwave for 5 minutes." Or, to cook for 2 minutes and 39 seconds, say "Alexa, microwave for 2 minutes and 39 seconds."

"Alexa, add X to microwave."

While microwaving, you can ask to cook for additional time by saying "Alexa, add X in the microwave," where X is the amount of time you'd like to add. For example, to add 2 minutes to the cooking time while the microwave is already running, say "Alexa, add 2 minutes to the microwave."

NOTE : By default, the oven will microwave at power 10 (maximum power)

"Alexa, microwave for X on power Y."

By default, your oven will microwave at power 10 (maximum power). To cook at a specific power, say "Alexa, microwave for X on power Y," where X is the amount of time you'd like to cook for and Y is the power level.

For example, to cook at power 5 for 3 minutes, say "Alexa, microwave for 3 minutes at power 5."

MICROWAVE COOK MODE

(1) Press "TIME COOK" once, the display will show "00:00".



(2) Press number keys to input the cooking time; the maximum cooking time is 99 minutes and 99 seconds.

(3) Press "POWER LEVEL" once, the display will show "PL10". The default power is 100% power. Now you can press number keys to adjust the power level.

(4) Press "START/+30SEC." to start cooking.

Example: to cook the food with 50% microwave power for 15 minutes.

a. Press "TIME COOK" once. "00:00" displays.

b. Press "1", "5", "0", "0" in order.

c. Press "POWER LEVEL" once, then press "5" to select 50% microwave power.

d. Press "START/+30SEC." to start cooking.



Note:

1. In the process of clock setting, if the "STOP/CLEAR" button is pressed or if there is no operation selected within 1 minute, the oven will go back to the previous setting automatically.

2. If "PL0" is selected, the oven will work with fan only and no power.

3. During microwave cooking, "POWER LEVEL" can be pressed to change the power you need. After pressing "POWER LEVEL", the current power will light for 3 seconds, now you can press number button to change the power. The oven will work with the selected power for the rest of the cooking time.

CONTROLS

EXPRESS COOK

- (1) If not already cooking, press number pads 1-6 to quickly cook from 1-6 minutes at 100% power. Press " START/+30SEC." to increase the cooking time by 30 second increments; the maximum cooking time is 99 minutes and 99 seconds.
- (2) To cook for 30 seconds at 100% power press "START/+30SEC". Each press on the same button will increase cooking time by 30 seconds. The maximum cooking cooking time is 99 minutes and 99 seconds.

Note: During microwave cooking and time defrost, time can be added by pressing "START/+30SEC." button.

+30 SEC

+30 sec allows you to reheat for 30 seconds at 100% (full power) by simply pressing the START/+30 sec pad.

By repeatedly pressing the START/+30 sec pad, you can extend the cooking time up to 99 minutes and 99 seconds, in 30-second increments.

You can also add 30 seconds using an Alexa Voice Command. For example:

"Alexa, microwave for 30 seconds."

"Alexa, cook for 30 seconds."

"Alexa, add 30 seconds to microwave."



START
+30 SEC

1. Press the START/+30 sec pad.

When you press the START/+30 sec pad, ":30" is displayed, and the oven starts reheating

NOTE :
+30 SEC cannot be used with AUTO COOK MENU or AUTO DEFROST.

CONTROLS

AUTO DEFROSTING

"Alexa, defrost X of meat."

" Alexa, defrost X of Poultry "

"Alexa, defrost X of Fish "

AUTO DEFROST lets you easily defrost food by eliminating guesswork in determining defrosting time. Follow the steps below for easy defrosting.

- (1) Press "Meat" repeatedly until "16", "24", "32", "40" oz display in order.
- (2) Press "Poultry" repeatedly until "24", "32", "40", "48" oz display in order.
- (3) Press "Fish" repeatedly until "8", "16", "24", "32" oz display in order.
- (4) Press "START/+30 SEC." to cook, to start defrosting and the cooking time remaining will be displayed. When cooking is finished, a buzzer sounds five times.



The defrosting time is automatically determined by the weight selected. When the defrosting time ends, you will hear 5 beeps.

TIME DEFROSTING

"Alexa, defrost for 10 minutes."

When TIME DEFROST is selected, the automatic cycle divides the defrosting time into periods of alternating defrost and stand times by cycling on and off.

- (1) Press " TIME DEFROST, " the display will show "00:00".
- (2) Press number pads to input defrosting time. The effective time range is 0:01-99:99.
- (4) Press " START/+30SEC. " to start defrosting. The remaining cooking time will be displayed.



When you touch START pad, the display counts down the time to show you how much defrosting time is left in the TIME DEFROST mode. When the defrosting time ends, you will hear 5 beeps.

CONTROLS

MULTI-STAGE COOKING

At most, 2 stages can be set for cooking. In multi-stage cooking, if one stage is defrosting, then defrosting shall be placed at the first stage automatically.

Note: Auto cooking cannot work in the multi-stage cooking.

Example: if you want to cook with 80% microwave power for 5 minutes + 60% microwave power for 10 minutes. The cooking steps are as following:

- (1) Press "TIME COOK" once, then press "5","0","0" to set the cooking time;
- (2) Press "POWER LEVEL" once, then press "8" to select 80% microwave power.
- (3) Press "TIME COOK" once, then press "1","0","0","0" to set the cooking time;
- (4) Press "POWER LEVEL" once, then press "6" to select 60% microwave power.
- (5) Press "START/ +30 SEC." to start cooking.

ONE TOUCH COOK

One touch cooking allows you to cook or reheat many of your favorite foods by touching just one pad.

To increase quantity, touch the chosen pad until the number in the display is same as desired quantity to cook.

CONTROLS

"Alexa, microwave classic popcorn."

To microwave a classic size bag of Orville Redenbacher's microwave popcorn (3.3oz), say "Alexa, microwave classic popcorn."

"Alexa, microwave mini popcorn."

To microwave a single size bag of Orville Redenbacher's microwave popcorn (1.5 oz), say "Alexa, microwave mini popcorn."

POPCORN

- (1) Press "POPCORN" repeatedly until the package size of your popcorn appears in the display, "3.3", "1.5" will display in order.

For example, press "POPCORN" once, "3.3" appears.

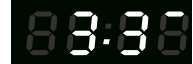

- (2) Press "START/+30 SEC." to cook, buzzer sounds once. When cooking finished, buzzer will sound five times.
-

"Alexa, microwave X potato."

POTATO

- (1) Press "POTATO" repeatedly until the number you wish appears in the display, "1", "2", "3" will display in order.

"1": 1 potato (approximate 8 oz)

"2": 2 potatoes (approximate 16 oz)

"3": 3 potatoes (approximate 24 oz)

For example, press "POTATO" once, "1" appears.

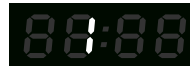

- (2) Press "START/+30 SEC." to cook, buzzer sounds once. When cooking is finished, a buzzer sounds five times.
-

"Alexa, microwave X of Frozen vegetables."

"Alexa, microwave X of Fresh vegetables."

VEGGIE

- (1) Press "VEGGIE" repeatedly and the display would show U-1 (Frozen Vegetable), U-2 (Fresh Vegetable), then press "START/+30 SEC." to confirm.

- (2) If choosing U-1, press "VEGGIE" repeatedly until "4.0", "8.0", "16.0" oz display in order.

- (3) If choosing U-2, press "VEGGIE" repeatedly until "4.0", "8.0", "16.0" oz display in order.

- (4) Press "START/+30 SEC." to cook, buzzer sounds once. When cooking is finished, a buzzer sounds five times.



CONTROLS

"Alexa, microwave X cup of Beverage"

"Alexa, reheat X cup of Beverage"

BEVERAGE

(1) Press " BEVERAGE " repeatedly until the number you wish appears in the display. "1", "2", "3" cup will display in order.

For example, press "BEVERAGE" once, "1" appears.



(2) Press "START/+30 SEC." to cook, buzzer sounds once. When cooking is finished, a buzzer sounds five times.

"Alexa, reheat X of dinner plate."

"Alexa, reheat X of leftovers."

REHEAT

(1) Press " REHEAT " repeatedly until the number you wish appears in the display, "9.0","12.0","18.0" oz will display in order.

For example, press "REHEAT" once, "9.0" appears.



(2) Press "START/+30 SEC." to cook, buzzer sounds once. When cooking is finished, a buzzer sounds five times.

"Alexa, microwave X of frozen pizza."

PIZZA

(1) Press " FROZEN PIZZA " repeatedly until the weight of your pizza appears in the display, "4.0", "8.0", "14.0" oz will display in order.

For example, press "FROZEN PIZZA" once, "4.0" appears.



(2) Press "START/+30 SEC." to cook, buzzer sounds once. When cooking is finished, a buzzer sounds five times.

CONTROLS

CHILD SAFETY LOCK

Lock: In waiting state, press " STOP/CLEAR " for 3 seconds, there will be a long "beep" denoting the entering into the child-lock state; meanwhile, the display will show " ".

Lock Cancel: In locked state, press " STOP/CLEAR " for 3 seconds, there will be a long "beep" denoting that lock is released.

INQUIRING FUNCTION

- (1) In microwave or multi-stage cooking state, press " TIMER/ CLOCK ", the display will show the clock for three seconds.
- (2) In the microwave or multi-stage cooking, press " POWER LEVEL " to inquire microwave power level, and the current microwave power will be displayed. After three seconds, the oven will turn back to the previous state.

TO STOP THE OVEN WHILE THE OVEN IS OPERATING

" Alexa, stop the microwave "

" Alexa, pause the microwave "

" Alexa, restart/resume the microwave "

1. Press the STOP/CLEAR pad.
 - You can restart the oven by pressing the START/+30 SEC pad.
 - Press the STOP/CLEAR pad once more to erase all instructions.
 - You must enter in new instructions.
2. Open the door.
 - You can restart the oven by closing the door and pressing the START/+30 SEC pad.

NOTE: Oven stops operating when door is opened.

SILENT MODE

To deactivate the silent mode:

In silent mode, press and hold "8" for 3 seconds. A long beep will sound. When you press the keys, it will make a sound. This will enable the end of cooking reminder.

To activate the silent mode:

In waiting state, press and hold "8" for 3 seconds. A long beep will sound. When you press the keys, it does not make a sound. This also disables the end of cooking reminder.

CARE OF YOUR MICROWAVE OVEN

The oven should be cleaned regularly and any food deposits removed.

Failure to maintain the oven in a clean condition could lead to deterioration of the surface that could adversely affect the life of the appliance and possibly result in a hazardous situation.

- 1 Turn the oven off before cleaning.
- 2 Keep the inside of the oven clean. When food spatters or spilled liquids adhere to oven walls, wipe with a damp cloth. Mild detergent may be used if the oven gets very dirty. The use of harsh detergent or abrasives is not recommended.
- 3 The outside oven surface should be cleaned with soap and water, rinsed and dried with a soft cloth. To prevent damage to the operating parts inside the oven, water should not be allowed to seep into the ventilation openings.
- 4 If the Control Panel becomes wet, clean with a soft, dry cloth. Do not use harsh detergents or abrasives on Control Panel.
- 5 If steam accumulates inside or around the outside of the oven door, wipe with a soft cloth. This may occur when the microwave oven is operated under high humidity conditions and in no way indicates malfunction of the unit.
- 6 It is occasionally necessary to remove the glass tray for cleaning. Wash the tray in warm sudsy water or in a dishwasher.
- 7 The roller guide and oven cavity floor should be cleaned regularly to avoid excessive noise. Simply wipe the bottom surface of the oven with mild detergent water or window cleaner and dry. The roller guide may be washed in mild sudsy water.

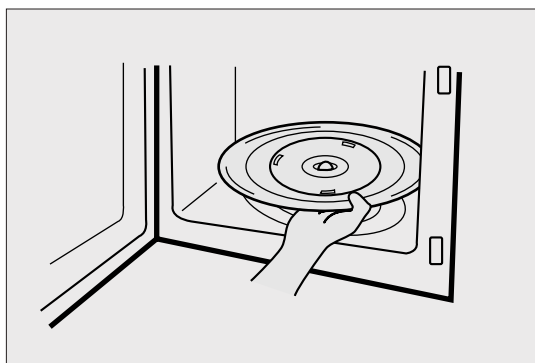

ROLLER GUIDE

- 1 The ROLLER GUIDE and oven floor should be cleaned frequently to prevent excessive noise.
- 2 The ROLLER GUIDE MUST ALWAYS be used for cooking together with the Glass Tray.

GLASS TRAY

- 1 DO NOT operate the oven without the Glass Tray in place.
- 2 DO NOT use any other Glass Tray with this oven.
- 3 If Glass Tray is hot, ALLOW TO COOL before cleaning or placing it in water.
- 4 DO NOT cook directly on the Glass Tray. (Except for popcorn)

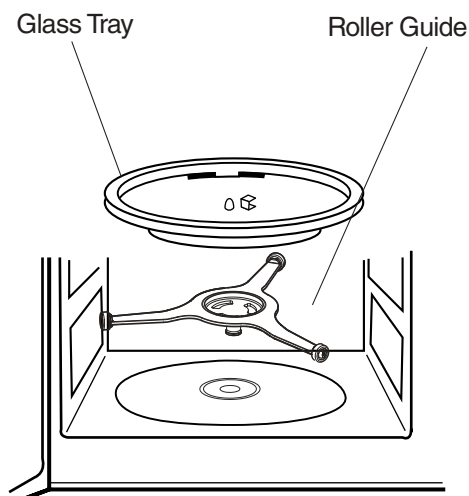

CARE OF YOUR MICROWAVE OVEN

BEFORE YOU CALL FOR SERVICE

Refer to following checklist, you may prevent an unnecessary service call.

- * The oven doesn't work :
 1. Check that the power cord is securely plugged in.
 2. Check that the door is firmly closed.
 3. Check that the cooking time is set.
 4. Check for a blown circuit fuse or tripped main circuit breaker in your house.
- * Sparking in the cavity;
 1. Check utensils. Metal containers or dishes with metal trim should not be used.
 2. Check that metal skewers or foil does not touch the interior walls.

CARE AND CLEANING

Although your oven is provided with safety features, it is important to observe the following:

1. It is important not to defeat or tamper with safety interlocks.
2. Do not place any object between the oven front face and the door or allow residue to accumulate on sealing surfaces. Wipe the sealing area frequently with a mild detergent, rinse and dry. Never use abrasive powders or pads.
3. When opened, the door must not be subjected to strain, for example, a child hanging on an opened door or any load could cause the oven to fall forward to cause injury and also damage to the door. Do not operate the oven if it is damaged, until it has been repaired by a competent service technician. It is particularly important that the oven closes properly and that there is no damage to the:
 - i) Door(bent)
 - ii) Hinges and Hookes(broken or loosened)
 - iii) Door seals and sealing surfaces.
4. The oven should not be adjusted or repaired by anyone except a properly competent service technician.
5. The oven should be cleaned regularly and any food deposits removed;
6. Failure to maintain the oven in a clean condition could lead to deterioration of the surface that could adversely affect the life of the appliance and possibly result in a hazardous situation.

QUESTIONS AND ANSWERS

- * Q : I accidentally ran my microwave oven without any food in it. Is it damaged?**
A : Running the oven empty for a short time will not damage the oven. However, it is not recommended.
- * Q : Can the oven be used with the glass tray or roller guide removed?**
A : No. Both the glass tray and roller guide must always be used in the oven before cooking.
- * Q : Can I open the door when the oven is operating?**
A : The door can be opened anytime during the cooking operation. Then microwave energy will be instantly switched off and the time setting will maintain until the door is closed.
- * Q : Why do I have moisture in my microwave oven after cooking?**
A : The moisture on the side of your microwave oven is normal. It is caused by steam from cooking food hitting the cool oven surface.
- * Q : Does microwave energy pass through the viewing screen in the door?**
A : No. The metal screen bounces back the energy to the oven cavity. The holes are made to allow light to pass through. They do not let microwave energy pass through.
- * Q : Why do eggs sometimes pop?**
A : When baking or poaching eggs, the yolk may pop due to steam build-up inside the yolk membrane. To prevent this, simply pierce the yolk with a toothpick before cooking. Never cook eggs without piercing their shells.
- * Q : Why is this standing time recommended after the cooking operation has been completed?**
A : Standing time is very important.
With microwave cooking, the heat is in the food, not in the oven. Many foods build up enough internal heat to allow the cooking process to continue, even after the food is removed from the oven. Standing time for joints of meat, large vegetables and cakes is to allow the inside to cook completely, without overcooking the outside.
- * Q : What does “standing time” mean?**
A : “Standing time” means that food should be removed from the oven and covered for additional time to allow it to finish cooking. This frees the oven for other cooking.
- * Q : Why does my oven not always cook as fast as the microwave cooking guide says?**
A : Check your cooking guide again, to make sure you’ve followed directions exactly ; and to see what might cause variations in cooking time. Cooking guide times and heat settings are suggestions, to help prevent over-cooking... the most common problem in getting used to a microwave oven.
Variations in the size, shape and weights and dimensions could require longer cooking time. Use your own judgement along with the cooking guide suggestions to check whether the food has been properly cooked just as you would do with a conventional cooker.
- * Q : Will the microwave oven be damaged if it operates while empty?**
A : Yes. Never run it empty.
- * Q : Can I operate my microwave oven without the turntable or turn the turntable over to hold a large dish?**
A : No. If you remove or turn over the turntable, you will get poor cooking results. Dishes used in your oven must fit on the turntable.
- * Q : Is it normal for the turntable to turn in either direction?**
A : Yes. The turntable rotates clockwise or counterclockwise, depending on the rotation of the motor when the cooking cycle begins.
- * Q : Can I pop popcorn in my microwave oven? How do I get the best results?**
A : Yes. Pop packaged microwave popcorn following manufacture’s guidelines. Do not use regular paper bags. Use the “listening test” by stopping the oven as soon as the popping slows to a “pop” every 1 or 2 seconds. Do not repop unpopped kernels. Do not pop popcorn in glass cookware.

COOKING INSTRUCTIONS

UTENSIL GUIDE

Only use utensils that are suitable for use in microwave ovens.

To cook food in the microwave oven, the microwaves must be able to penetrate the food, without being reflected or absorbed by the dish used. Care must therefore be taken choosing the utensil. If the utensil is marked microwave-safe, you do not need to worry. The following table lists various utensil and indicates whether and how they should be used in a microwave oven.

UTENSIL	SAFE	COMMENTS
Aluminium foil	▲	Can be used in small quantities to protect areas against overcooking. Arcing can occur if the foil is too close to the oven wall or if too much foil is used.
Crust plate	●	Do not preheat for more than 8 minutes.
China and earthenware	●	Porcelain, pottery, glazed earthenware and bone china are usually suitable, unless decorated with a metal trim.
Disposable polyester cardboard dishes	●	Some frozen foods are packaged in these dishes.
Fast-food packaging • Polystyrene cups containers	●	Can be used to warm food. Overheating may cause the polystyrene to melt. May catch fire. May cause arcing.
• Paper bags or newspaper	×	
• Recycled paper or metal trims	×	
Glassware • Oven-to-table ware • Fine glassware • Glass jars	● ● ●	Can be used, unless decorated with a metal trim. Can be used to warm foods or liquids. Delicate glass may break or crack if heated suddenly. Must remove the lid. Suitable for warming only.
Metal • Dishes • Freezer bag twist ties	× ×	May cause arcing or fire.
Paper • Plates, cups, napkins and paper towels • Recycled paper	● ×	For short cooking times and warming. Also to absorb excess moisture. May cause arcing.
Plastic • Containers • Cling film • Freezer bags	● ● ▲	Particularly if heat-resistant thermoplastic. Some other plastics may warp or discolour at high temperatures. Do not use Melamine plastic. Can be used to retain moisture. Should not touch the food. Take care when removing the film as hot steam will escape. Only if boilable or oven-proof. Should not be airtight. Prick with a fork, if necessary.
Wax or grease-proof paper	●	Can be used to retain moisture and prevent spattering.

- : Recommended use
- ▲ : Limited Use
- × : Not Recommended

COOKING INSTRUCTIONS

USE YOUR MICROWAVE OVEN SAFELY

General Use

Do not attempt to defeat or tamper with safety interlocks.

Do not place any object between the oven front frame and the door or allow residue to build up on sealing surfaces. Wipe with a mild detergent, rinse and dry. Never use abrasive powders or pads.

Do not subject the oven door to strain or weight such as a child hanging on an open door.

This could cause the oven to fall forward resulting in injury to you and damage to the oven.

Do not operate the oven if door seals or sealing surfaces are damaged; or if door is bent; or if hinges are loose or broken.

Do not operate the oven empty. This will damage the oven.

Do not attempt to dry clothes, newspapers or other materials in the oven. They may catch on fire.

Do not use recycled paper products as they may contain impurities which may cause sparks or fires.

Do not hit or strike the control panel with hard objects. This can damage the oven.

Food

Never use your microwave oven for home canning. The oven is not designed for proper home canning. Improperly canned food may spoil and be dangerous to consume.

Always use the minimum recipe cooking time. It is better to undercook rather than overcook foods.

Undercooked foods can be returned to the oven for more cooking. If food is overcooked, nothing can be done.

Heat small quantities of food or foods with low moisture carefully. These can quickly dry out, burn or catch on fire.

Do not heat eggs in the shell. Pressure may build up and eggs can explode.

Potatoes, apples, egg yolks and sausages are examples of food with non-porous skins.

These must be pierced before cooking to prevent bursting.

Do not attempt to deep fat fry in your microwave oven. Always allow a standing time of at least 20 seconds after the oven has been switched off to allow the

temperature to even out, stir during heating, if necessary, and ALWAYS stir after heating. To prevent eruptive boiling and possible scalding, you should put a spoon or glass stick into the beverages and stir before, during and after heating.

Do not leave the oven unattended while popping corn. Do not pop corn in a paper bag unless it is the commercially prepared Microwave Popcorn product. The kernels can overheat and ignite a brown paper bag.

Do not put packaged Microwave Popcorn bags directly on the oven tray. Place the package on a microwave safe glass or ceramic plate to avoid overheating and cracking the oven tray.

Do not exceed the Microwave Popcorn manufacturers suggested popping time.

Longer popping does not yield more popcorn but it can result in scorch, burn or fire. Remember, the Popcorn bag and tray can be too hot to handle. Remove with caution and use pot holders.

ARCING

If you see arcing, open the door and correct the problem.

Arcing is the microwave term for sparks in the oven.

Arcing is caused by:

- Metal or foil touching the side of the oven.
- Foil not molded to food (upturned edges act like antennas).

- Metal, such as twist-ties, poultry pins, or gold rimmed dishes, in the microwave.
- Recycled paper towels containing small metal pieces being used in the microwave.

COOKING INSTRUCTIONS

MICROWAVING PRINCIPLES

Microwave energy has been used in this country to cook and reheat food since early experiments with RADAR in World War II. Microwaves are present in the atmosphere all the time, both naturally and manmade sources. Manmade sources include radar, radio, television, telecommunication links and car phones.

HOW MICROWAVES COOK FOOD

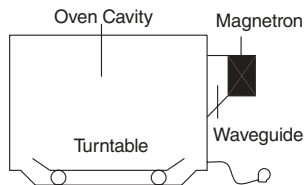

In a microwave oven, electricity is converted into microwave by the **MAGNETRON**.

►TRANSMISSION

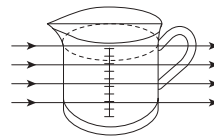

Then they pass through the cooking containers to be absorbed by the water molecules in the food, all foods contain water to a more or lesser extent.

►REFLECTION

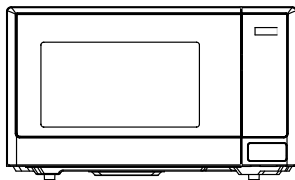

The microwaves bounce off the metal walls and the metal door screen.

►ABSORPTION

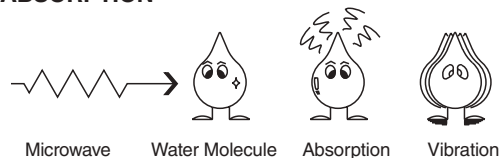

The microwaves cause the water molecules to vibrate which causes **FRICION**, i.e. **HEAT**. This heat then cooks the food. Microwaves are also attracted to fat and sugar particles, and foods high in these will cook more quickly. Microwaves can only penetrate to a depth of 1½ - 2 inches(4-5cm) and as heat spreads through the food by conduction, just as in a traditional oven, the food cooks from the outside inwards.

CONVERSION CHARTS

WEIGHT MEASURES		VOLUME MEASURES		SPOON MEASURES	
15 g	1/2 oz.	30 ml	1 fl.oz.	1.25 ml	1/4 tsp
25 g	1 oz.	100 ml	3 fl.oz.	2.5 ml	1/2 tsp
50 g	2 oz.	150 ml	5 fl.oz. (1/4 pt)	5 ml	1 tsp
100 g	4 oz.	300 ml	10 fl.oz. (1/2 pt)	15 ml	1 tbsp
175 g	6 oz.	600 ml	20 fl.oz. (1pt)		
225 g	8 oz.				
450 g	1 lb.				

FLUID MEASUREMENTS		
1 Cup	= 8 fl.oz	= 240 ml
1 Pint	= 16 fl.oz. (UK 20 fl.oz.)	= 480 ml (UK 560 ml)
1 Quart	= 32 fl.oz. (UK 40 fl.oz.)	= 960 ml (UK 1120 ml)
1 Gallon	= 128 fl.oz. (UK 160 fl.oz.)	= 3840 ml (UK 4500 ml)

COOKING INSTRUCTIONS

COOKING TECHNIQUES

STANDING TIME

Dense foods e.g. meat, jacket potatoes and cakes, require standing time (inside or outside of the oven) after cooking, to allow heat to finish conducting to cook the center completely. Wrap meat joints and jacket potatoes in aluminium foil while standing. Meat joints need approx. 10-15 minutes, jacket potatoes 5 minutes. Other foods such as plated meal, vegetables, fish etc require 2-5 minutes standing. After defrosting food, standing time should also be allowed. If food is not cooked after standing time, return to the oven and cook for additional time.

MOISTURE CONTENT

Many fresh foods e.g. vegetables and fruit, vary in their moisture content throughout the season, particularly jacket potatoes. For this reason cooking times may have to be adjusted. Dry ingredients e.g. rice, pasta, can dry out during storage so cooking times may differ.

DENSITY

Porous airy foods heat more quickly than dense heavy foods.

CLING FILM

Cling film helps keep the food moist and the trapped steam assists in speeding up cooking times. Pierce before cooking to allow excess steam to escape. Always take care when removing cling film from a dish as the build-up of steam will be very hot.

SHAPE

Even shapes cook evenly. Food cooks better by microwave when in a round container rather than square.

SPACING

Foods cook more quickly and evenly if spaced apart. NEVER pile foods on top of each other.

STARTING TEMPERATURE

The colder the food, the longer it takes to heat up. Food from a fridge takes longer to reheat than food at room temperature.

LIQUIDS

All liquids must be stirred before and during heating. Water especially must be stirred before and during heating, to avoid eruption. Do not heat liquids that have previously been boiled. DO NOT OVERHEAT.

TURNING & STIRRING

Some foods require stirring during cooking. Meat and poultry should be turned after half the cooking time.

ARRANGING

Individual foods e.g. chicken portions or chops, should be placed on a dish so that the thicker parts are towards the outside.

QUANTITY

Small quantities cook faster than large quantities, also small meals will reheat more quickly than large portions.

PIERCING

The skin or membrane on some foods will cause steam to build up during cooking. These foods must be pierced or a strip of skin should be peeled off before cooking to allow the steam to escape. Eggs, potatoes, apples, sausages etc, will all need to be pierced before cooking. DO NOT ATTEMPT TO BOIL EGGS IN THEIR SHELLS.

COVERING

Cover foods with microwave cling film or a lid. Cover fish, vegetables, casseroles, soups. Do not cover cakes, sauces, jacket potatoes or pastry items.

COOKING INSTRUCTIONS

DEFROSTING GUIDE

- ▶ Do not defrost covered meat. Covering might allow cooking to take place. Always remove outer wrap and tray. Use only containers that are microwave-safe.
- ▶ Begin defrosting whole poultry breast-side-down. Begin defrosting roasts fat-side-down.
- ▶ The shape of the package alters the defrosting time. Shallow rectangular shapes defrost more quickly than a deep block.
- ▶ After $\frac{1}{3}$ of the defrost time has elapsed, check the food. Toy may wish to turn over, break apart, rearrange or remove thawed portions of the food.
- ▶ During defrost, the oven will prompt you to turn the over. At this point, open oven door and check the food. Follow the techniques listed below for optimum defrost results.
Then, close oven door, touch the START pad to complete defrosting.
- ▶ When defrosted, food should be cool, but softened in all areas. If still slightly icy, return to microwave oven very briefly, or let stand a few minutes. After defrosting, allow food to stand 5-60 minutes if there are any icy areas.
Poultry and fish may be placed under running cool water until defrosted
- ⇒ **Turn over** : Roast, ribs, whole poultry, turkey breasts, hot dogs, sausages, steaks, or chops.
- ⇒ **Rearrange** : Break apart or separate steaks, chops, hamburger patties, ground meat, chicken or seafood pieces, chunks of meat such as stew beef.
- ⇒ **Shield** : Use small strips of aluminum foil to protect thin areas or edges of unevenly shaped foods such as chicken wings. To prevent arcing, do not allow foil to come within 1-inch of oven walls or door.
- ⇒ **Remove** : To prevent cooking, thawed portions should be removed from the oven at this point. This may shorten defrost time for food weighing less than 3 lbs.(1350g).

Cooking chart

ITEM	POWER LEVEL	COOKING TIME PER LB./450G	SPECIAL INSTRUCTION
MEAT			
Beef joint - Rare	PL8	6-8 min.	- Chilled meat and poultry should be removed from the refrigerator at least 30 minutes before cooking. - Always let the meat and poultry stand, covered after cooking.
- Medium	PL8	7-9 min.	
- well done	PL8	9-11 min.	
Pork Joint	PL10	10-13 min.	
Bacon joint	PL10	8-10 min.	
POULTRY			
Whole chicken	PL10	4-9 min.	
Portions chicken	PL8	5-7 min.	
Breast (boned)	PL8	6-8 min.	
FISH			
Fish Fillets	PL10	3-5 min.	- Brush a little oil or melted butter over the fish, or add 15~30ml(1-2 tbsp) lemon juice, wine, stock, milk or water. - Always let the fish stand, covered, after cooking
Whole Mackerel, Cleaned and prepared	PL10	3-5 min.	
Whole Trout, Cleaned & Prepared	PL10	4-6 min.	
Salmon steaks	PL10	4-6 min.	

NOTE : The above times should be regarded only as a guide. Allow for difference in individual tastes and preferences. The times may vary due to the shape, cut, and composition of the food. Frozen meat, poultry and fish must be thoroughly thawed before cooking.

COOKING INSTRUCTIONS

COOKING & REHEATING CHART

Reheating chart

- Baby food particularly needs to be checked carefully before serving to prevent burns.
- When heating pre-packaged ready-cooked foods, always follow the pack instructions carefully.
- If you freeze foods which were bought from the fresh or chilled counters, remember that they should be thoroughly thawed before following the heating instructions on the pack. It's worth putting a note on them so that other members of the household will remember too.
- Remember metal ties and transfer food from foil containers before reheating.
- Chilled(refrigerated) food takes longer to reheat than food at room temperature (such as just-cooled food or food from the store cupboard).
- All foods should be reheated using full microwave power.

ITEM	COOKING TIME	SPECIAL INSTRUCTIONS
Baby food 128g jar	20 sec.	Empty into a small serving bowl. Stir well once or twice during heating. Before serving, check the temperature carefully.
Baby milk 100ml / 4fl.oz. 225ml / 8fl.oz.	20-30 sec. 40-50 sec.	Stir or shake well and pour into a sterilized bottle. Before serving, shake well and check the temperature carefully.
Sandwich roll or bun 1 roll	20-30 sec.	Wrap in paper towel and place on glass microwaveable rack. *Note : Do not use recycled paper towels.
Lasagna 1 serving (10 ½ oz./300g)	4-6 min.	Place lasagna on microwaveable plate. Cover with plastic wrap and vent.
Casserole 1 cup 4 cups	1 ½-3 min. 5-7 min.	Cook covered, in microwaveable casserole. Stir once halfway through cooking.
Mashed potatoes 1 cup 4 cups	2-3 min. 6-8 min.	Cook covered, in microwaveable casserole. Stir once halfway through cooking.
Baked beans 1 cup	2-3 min.	Cook covered, in microwaveable casserole. Stir once halfway through cooking.
Ravioli or pasta in sauce 1 cup 4 cups	2-3 min. 6-9 min.	Cook covered, in microwaveable casserole. Stir once halfway through cooking.

COOKING INSTRUCTIONS

VEGETABLE CHART

Use a suitable glass pyrex bowl with lid. Add 30-45ml cold water(2-3 tbsp.) for every 250g unless another water quantity is recommended - see table. Cook covered for the minimum time - see table.

Continue cooking to get the result you prefer. Stir once during and once after cooking. Add salt, herbs or butter after cooking. Cover during a standing time of 3 minutes.

Hint : cut the fresh vegetables into even sized pieces. The smaller they are cut, the quicker they will cook.

All vegetables should be cooked using full microwave power.

Cooking Guide for fresh vegetables

VEGETABLES	WEIGHT	TIME	COMMENTS
Broccoli	½ lb./250g 1 lb./500g	2-3 min 4-6 min	Prepare even sized florets. Arrange the stems to the centre.
Brussels sprouts	½ lb./250g	3-4 min	Add 60-75ml(4-5 tbsp.) water.
Carrots	½ lb./250g	2-3 min	Cut Carrots into even sized slices.
Cauliflower	½ lb./250g 1 lb./500g	2-3 min 4-6 min	Prepare even sized florets. Cut big florets into halves. Arrange stems to the centre.
Courgettes	½ lb./250g	2-3 min	Cut Courgettes into slices. Add 30ml(2tbsp.) water or a knob of butter. Cook until just tender.
Aubergine (eggplant)	½ lb./250g	2-3 min	Cut Aubergine into small slices and sprinkle with 1 table-spoon lemon juice.
Leeks	½ lb./250g	2-3 min	Cut Leeks into thick slices.
Mushrooms	0.3 lb./125g ½ lb./250g	1-2 min 2-4 min	Prepare small whole or sliced Mushrooms. Do not add any water. Sprinkle with lemon juice. Spice with salt and pepper. Drain before serving.
Onions	½ lb./250g	2-3 min	Cut Onions into slices or halves. Add only 15ml(1tbsp.) water.
Pepper	½ lb./250g	2-4 min	Cut Pepper into small slices.
Potatoes	½ lb./250g 1 lb./500g	3-5 min 5-7 min	Weigh the peeled Potatoes and cut them into similar sized halves or quarters.
Turnip cabbage	½ lb./250g	4-6 min	Cut Turnip cabbage into small cubes.

Cooking Guide for frozen vegetables

VEGETABLES	WEIGHT	TIME	INSTRUCTIONS
spinach	0.3 lb./125g	1-2 min	Add 15ml(1tbsp.) cold water.
broccoli	½ lb./250g	2½-4 min	Add 30ml(2 tbsp.) cold water.
Peas	½ lb./250g	2½-4 min	Add 15ml(1 tbsp.) cold water.
Green beans	½ lb./250g	3-5 min	Add 30ml(2 tbsp.) cold water.
Mixed vegetables (carrots/peas/corn)	½ lb./250g	2½-4 min	Add 15ml(1 tbsp.) cold water.
Mixed vegetables (Chinese style)	½ lb./250g	3-5 min	Add 15ml(1 tbsp.) cold water.

COOKING INSTRUCTIONS

RECIPES

TOMATO & ORANGE SOUP

1 oz.(25g) butter
1 medium onion, chopped
1 large carrot & 1 large potato, chopped
1³/₄lb(800g) canned, chopped tomatoes
juice and grated rind of 1 small orange
1¹/₂pints(900ml) hot vegetable stock
salt and pepper to taste

1. Melt the in a large bowl on PL10 for 1 minute.
2. Add the onion, carrot and potato and cook on PL10 for 4 minutes. stir halfway through cooking.
3. Add the tomatoes, orange juice, orange rind and stock. Mix thoroughly. Season with salt and pepper to taste. Cover the bowl and cook on PL10 for 15 minutes. stir 2-3 times during cooking, until the vegetables are tender.
4. Blend and serve immediately.

FRENCH ONION SOUP

1 large onions, sliced
1 tbsp (15ml) corn oil
2 oz.(50g) plain flour
2 pints(1.2 liters) hot meat
or vegetable stock
salt and pepper to taste
2 tbsp (30ml) parsley, chopped
4 thick slices French bread
2 oz.(50g) cheese, grated

1. Place the onion and oil a bowl, mix well and cook on PL10 for 1 minutes.
2. Stir in the flour to make a paste and gradually add stock. Season and add the parsley.
3. Cover the bowl and cook on PL7 for 16 minutes.
4. Pour the soup into serving bowls, submerge bread and sprinkle generously with cheese.
5. Cook on PL7 for 2 minutes, until the cheese has melted.

STIR FRIED VEGETABLES

1 tbsp(15ml) sunflower oil
2 tbsp (30ml) soy sauce
1 tbsp (15ml) sherry
1"(2.5cm) root ginger,
peeled and finely grated
2 medium carrots, cut into fine strips
4 oz.(100g) button mushrooms,
chopped
2 oz.(50g) beansprouts
4 oz.(100g) mange-tout
1 red pepper, seeded and thinly sliced
4 spring onions, chopped
4 oz.(100g) canned water chestnuts,
sliced
1/4 head of chinese leaves, thinly sliced

1. Place the oil, soy sauce, sherry, ginger, garlic and carrots in a large bowl, mix thoroughly
2. Cover and cook on PL10 for 3-5 minutes, stirring once.
3. Add the button mushrooms, beansprouts, mange-tout, red pepper, spring onions, water chestnuts and chinese leaves. Mix thoroughly.
4. Cook on PL10 for 5-6 minutes, until the vegetables are tender. Stir 2-3 times during cooking.

Stir fried vegetables are ideally served with meat or fish.

HONEYED CHICKEN

4 boneless chicken breasts
2 tbsp(30ml) clear honey
1 tbsp(15ml) whole grain mustard
1/2 tsp(2.5ml) dried tarragon
1 tbsp(15ml) tomato puree
1/4 pint(150ml) chicken stock

1. Place the chicken breasts in a casserole dish.
2. Mix all remaining ingredients together and pour over the chicken. Salt and pepper to taste.
3. Cook on PL10 for 13-14 minutes. Rearrange and coat the chicken with the sauce twice during cooking.

COOKING INSTRUCTIONS

BLUE CHEESE & CHIVE JACKETS

2 baking potatoes,
(approx.9 oz.(250g) each)
2 oz.(50g) butter
4 oz.(100g) blue cheese, chopped
1 tbsp(15ml) fresh chives, chopped
2 oz.(50g) mushrooms, sliced
salt and pepper to taste

1. Prick each potato in several places. Cook on PL10 for 7-9 minutes. Halve and scoop the flesh into a bowl, add the butter, cheese, chives, mushrooms, salt and pepper, mix thoroughly.
2. Pile mixture into the potato skins and place in a flan dish.
3. Cook on PL5 for 10 minutes.

WHITE SAUCE

1 oz.(25g) butter
1 oz.(25g) plain flour
1/2 pint(300ml) milk
salt and pepper to taste

1. Place the butter in a bowl and cook on PL10 for 1 minute, until melted.
2. Stir in the flour and whisk in the milk. Cook on PL10 for 3-4 minutes, stirring every 2 minutes until thick and smooth. Season with salt and pepper to taste.

STRAWBERRY JAM

1 1/2 lb.(675g) strawberries, hulled
3 tbsp(45ml) lemon juice
1 1/2 lb.(675g) caster sugar

1. Place strawberries and lemon juice in a very large bowl, heat on PL10 for 4 minutes, or until the fruit has softened. Add sugar, mix well.
2. Cook on PL10 for 20-25 minutes, until setting point* is reached, stir every 4-5 minutes.
3. Pour into hot, clean jars. Cover, seal and label.

** setting point : To determine setting point, place 1 tsp(5ml)jam onto chilled saucer. Allow to stand for 1 minute. Move surface of jam gently with your finger, if the surface wrinkles setting point has been reached.*

PLAIN MICROWAVE CAKE

4 oz.(100g) margarine
4 oz.(100g) sugar
1 eggs
4 oz.(100g) self raising flour, sifted
2-3 tbsp(30-45ml) milk

1. line the base of 8" (20.4cm) cake dish with grease-proof paper.
2. Cream the margarine and sugar together until light and fluffy. Beat in the eggs and fold in the sifted flour alternately with the milk.
3. Pour into prepared container. Cook on PL10 for 4-5 minutes, until a skewer comes out cleanly.
4. Leave the cake to stand for 5 minutes before turning out.

OMELETTES

1/2 oz.(15g) butter
4 eggs
6 tbsp(90ml) milk
salt & pepper

1. Whisk together eggs and milk.
2. Place butter in 10"(26cm) flan dish. Cook on PL10 for 1 minute, until melted. Coat the dish with the melted butter.
3. Pour omelette mixture into flan dish. Cook on PL10 for 2 minutes. whisk mixture and cook again on PL10 for 1 minutes.

COOKING INSTRUCTIONS

SCRAMBLED EGG

1/2 oz.(15g) butter
2 eggs
2 tbsp(30ml) milk
salt & pepper

1. Melt the butter in a bowl on PL10 for 1 minute.
2. Add the eggs, milk and seasoning and mix well.
3. Cook on PL10 for 3 minutes, stirring every 30 seconds.

SAVORY MINCE

1 small onion, diced
1 clove garlic, crushed
1 tsp(5ml) oil
7 oz.(200g) can chopped tomatoes
1 tbsp(15ml) tomato puree
1 tsp(5ml) mixed herbs
8 oz.(225g) minced beef
salt and pepper

1. Place onion, garlic and oil in casserole, and cook on PL10 for 2 minutes or until soft.
2. Place all other ingredients in casserole. Stir well.
3. Cover and cook on PL10 for 5 minutes then PL5 for 8-13 minutes or until the meat is cooked.

SHARP®

**SHARP ELECTRONICS CORPORATION
100 Paragon Drive, Montvale, NJ 07645**