

# INDUCTION RANGE

## use & care

Introduction. . . . .	2	Before Setting Oven Controls. . . . .	22
Important Safety Instructions. . . . .	3	Setting Oven Controls . . . . .	23
Cooking Recommendations. . . . .	10	Care and Cleaning . . . . .	34
Before Setting Surface Controls . . . . .	13	Before You Call . . . . .	40
Setting Surface Controls. . . . .	19	Warranty . . . . .	44

# 2

## INTRODUCTION

### Welcome to our family

Thank you for bringing Frigidaire into your home! We see your purchase as the beginning of a long relationship together.

This manual is your resource for the use and care of your product. Please read it before using your appliance. Keep it handy for quick reference. If something doesn't seem right, the troubleshooting section will help you with common issues.

FAQs, helpful tips and videos, cleaning products, and kitchen and home accessories are available at [www.frigidaire.com](http://www.frigidaire.com).

We are here for you! Visit our website, chat with an agent, or call us if you need help. We may be able to help you avoid a service visit. If you do need service, we can get that started for you.

Let's make it official! Be sure to register your product.

Keep your product info here so it's easy to find.

Model Number: \_\_\_\_\_

Serial Number: \_\_\_\_\_

Purchase Date: \_\_\_\_\_

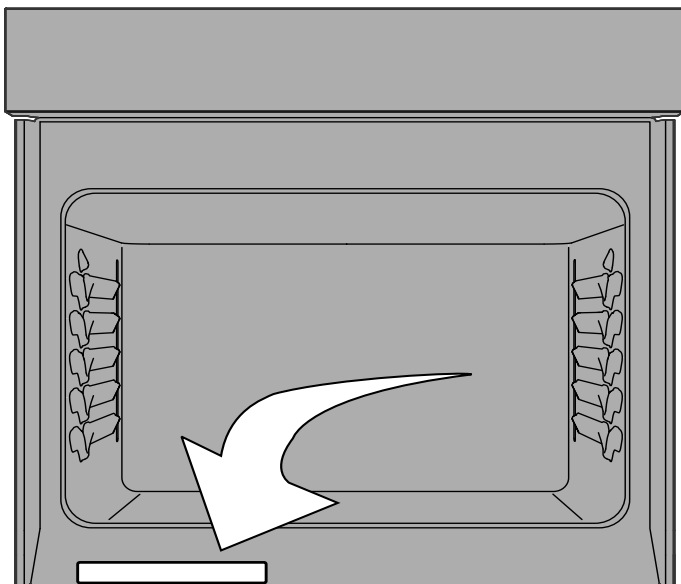

Serial Number Location

### ✓ Installation Checklist

- Read all the safety instructions in the front of your Use & Care Manual.
- Remove all packaging materials from your appliance before cooking.
- Confirm that the electrical power to the appliance is turned on.
- Wipe out the inside of the oven cavity with a damp cloth.
- Apply a thin layer of cooking oil to the sides of the oven racks to keep them gliding smoothly.
- Set the clock. See (page 20) for instructions.
- Test all surface elements/burners to make sure they are working properly (page 17).
- Before cooking, set the oven to bake at 350°F (177°C) for 30 minutes (page 23). Some noise and odors are normal on the first cooking cycle.
- Remember to complete your product registration!

Read all instructions before using this appliance.

This manual contains important safety symbols and instructions. Please pay attention to these symbols and follow all instructions given.

Do not attempt to install or operate your appliance until you have read the safety precautions in this manual. Safety items throughout this manual are labeled with a WARNING or CAUTION statement based on the risk type.

Warnings and important instructions appearing in this guide are not meant to cover all possible conditions and situations that may occur. Common sense, caution, and care must be exercised with installing, maintaining, or operating your appliance.

## DEFINITIONS

 This is the safety alert symbol. It is used to alert of potential personal injury hazards. Obey all safety messages that follow this symbol to avoid possible injury or death.

### WARNING

Indicates a potentially hazardous situation which, if not avoided, may result in death or serious injury.

### CAUTION

Indicates a potentially hazardous situation which, if not avoided, may result in minor or moderate injury.

### IMPORTANT

Indicates installation, operation or maintenance information which is important but not hazard-related.

### NOTE

Indicates a short, informal reference – something written down to assist the memory or for future reference.

### WARNING

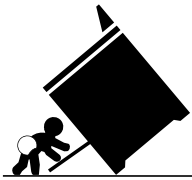

#### Tip Over Hazard

- A child or adult can tip the range and be killed.
- Verify the anti-tip device has been installed to floor or wall.

- Ensure the anti-tip device is re-engaged to floor or wall when the range is moved.
- Do not operate the range without the anti-tip device in place and engaged.
- Failure to follow these instructions can result in death or serious burns to children and adults.

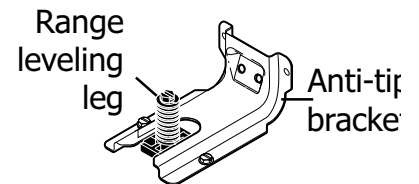

To check if the anti-tip bracket is installed properly, use both arms to grasp the rear edge of the range back. Carefully attempt to tilt range forward. When properly installed, the range should not tilt forward.

Refer to the anti-tip bracket installation instructions supplied with your range for proper installation.

# 4

## IMPORTANT SAFETY INSTRUCTIONS

---

### IMPORTANT INSTRUCTIONS FOR UNPACKING AND INSTALLATION

#### IMPORTANT

Read and follow the below instructions and precautions for unpacking, installing, and servicing your appliance.

Remove all tape and packaging before using the appliance. Destroy the carton and plastic bags after unpacking the appliance. Never allow children to play with packaging material. Do not remove the wiring label and other literature attached to the appliance. Do not remove model/serial number plate.

Cold temperatures can damage the electronic control. When using this appliance for the first time, or when the appliance has not been used for an extended period of time, be sure the appliance has been in temperatures above 32°F (0°C) for at least 3 hours before turning on the power to the appliance.

All materials used in construction of cabinets, enclosures, and supports surrounding the product must have a temperature rating above 200°F (94°C).

Never modify or alter the construction of the appliance by removing the leveling legs, panels, wire covers, anti-tip brackets/screws, or any other part of the appliance.

Be sure to have an appropriate foam-type fire extinguisher available, visible, and easily accessible located near the appliance.

### GROUNDING INSTRUCTIONS

#### WARNING

- Avoid fire hazard or electrical shock. Failure to follow this warning may cause serious injury, fire, or death.
- Avoid fire hazard or electrical shock. Do not use an adapter plug, use an extension cord, or remove grounding prong from the power cord. Failure to follow this warning may cause serious injury, fire, or death.

Proper Installation—Be sure your appliance is properly installed and grounded by a qualified technician. In the United States, install in accordance with the National Fuel Gas Code ANSI Z223.1/NPFA No. 54, latest edition and National Electrical Code NFPA No. 70 latest edition, and local electrical code requirements. In Canada, install in accordance with CAN/CGA B149.1 and CAN/CGA B149.2 and CSA Standard C22.1, Canadian Electrical code, Part 1-latest editions and local electrical code requirements. Install only per installation instructions provided in the literature package for this appliance.

For personal safety, this appliance must be properly grounded. For maximum safety, the power cord must be securely connected to an electrical outlet or junction box that is the correct voltage, is correctly polarized and properly grounded, and protected by a circuit breaker in accordance with local codes.

It is the personal responsibility of the consumer to have the appropriate outlet or junction box with the correct, properly grounded wall receptacle installed by a qualified electrician. It is the responsibility and obligation of the consumer to

contact a qualified installer to assure that the electrical installation is adequate and is in conformance with all local codes and ordinances.

See the installation instructions packaged with this appliance for complete installation and grounding instructions.

**IMPORTANT INSTRUCTIONS FOR USING THE APPLIANCE**

 **WARNING**

- Storage In or On Appliance—Flammable materials should not be stored in an oven or microwave, near surface burners or elements, or in the storage or warmer drawer (if equipped). This includes paper, plastic, and cloth items, such as cookbooks, plastic ware, and towels, as well as flammable liquids. Do not store explosives, such as aerosol cans, on or near the appliance.
- Do not leave children alone - Children should not be left alone or unattended in the area where appliance is in use. They should never be allowed to sit or stand on any part of the appliance, including the storage drawer, lower broiler drawer, warmer drawer, or lower double oven.
- Do not store items of interest to children in the cabinets above the appliance or on the backguards of ranges. Children climbing on or near the appliance to reach items could be seriously injured.
- Do not allow children to climb or play around the appliance. The weight of a child on an open oven door may cause the appliance to tip, resulting in serious burns or other injury. An open drawer when hot may cause burns.

 **WARNING**

- Stepping, leaning, or sitting on the door or drawers of this appliance can result in serious injuries and also cause damage to the appliance.
- Never cover any slots, holes or passages in the oven bottom or cover and entire rack with materials such as aluminum foil. Aluminum foil linings may also trap heat, causing a fire hazard.
- Do not use oven or warmer drawer (if equipped) for storage.
- Never use your appliance as a space heater to heat or warm the room. Doing so may result in carbon monoxide poisoning and overheating of the appliance.

 **CAUTION**

- When heating fat or grease, watch it closely. Grease may catch fire if it becomes too hot.
- Do not use water or flour on grease fires. Smother fire or flame or use dry chemical or foam-type extinguisher. Cover the fire with a pan lid or use baking soda.
- Use dry potholders. Moist or damp potholders on hot surfaces may result in burns from steam. Do not let potholders touch hot cooking areas. Do not use towels or other bulky cloths.
- Do not heat unopened food containers - Build-up of pressure may cause container to burst and result in injury.

# 6

## IMPORTANT SAFETY INSTRUCTIONS

---

### CAUTION

- Wear proper apparel - Loose-fitting or hanging garments should never be worn while using the appliance. Do not let clothing or other flammable materials contact hot surfaces.
- Do not touch surface burners or elements, areas near these burners or elements, interior surfaces of the oven, or the warmer drawer (if equipped). Surface burners and elements may be hot even though they appear cool. Areas near surface burners and elements may become hot enough to cause burns. During and after use, do not touch, or let clothing or other flammable materials touch these areas until they are cool. These areas may include the cooktop, surfaces facing the cooktop, oven vent areas, oven door, and oven window.
- Do not attempt to operate the appliance during a power failure. If the power fails, always turn off the appliance. If the appliance is not turned off and the power resumes, electric surface elements may resume operation when power is restored. Once the power resumes, reset the clock and the oven function.

### IMPORTANT INSTRUCTIONS FOR USING YOUR INDUCTION COOKTOP

#### CAUTION

- Persons with a pacemaker or similar medical device should exercise caution using or standing near an induction unit while it is in operation, as the electromagnetic field may affect the working of the pacemaker or similar medical device. It would be advisable to consult your doctor or the pacemaker or similar medical device manufacturer about your particular situation.
- Do not place metallic objects such as knives, forks spoons, and lids on the cooktop surface, since they can get hot.

Know which knob or key controls each surface heating area. Place cookware with food on the cooking area before turning it on. Turn the cooking area off before removing the cookware.

Cookware handles should be turned inward and not extend over adjacent surface elements. — To reduce the risk of burns, ignition of flammable materials, and spillage due to unintentional contact with the utensil, the handle of the cookware should be positioned so that it is turned inward, and does not extend over other cooking areas.

Glazed cooking utensils — Only certain types of cookware are suitable for cook top service and must be magnetic to work properly on the induction zones. Check the manufacturer's recommendations for cook top use to ensure that the cookware is compatible with induction cooking.

---

Improper cookware may break due to sudden changes in temperature. Check the cookware manufacturer's recommendations for cooktop use.

Use proper pan size - This appliance is equipped with one or more surface units of different sizes. Select cookware with flat bottoms that match the surface unit size. Using the proper cookware on the cooking area will improve efficiency.

Never leave surface elements unattended. Boil-overs may cause smoking and greasy spills that may ignite. A pan that has boiled dry could be damaged and may damage the cooktop.

When you are flaming foods under a ventilating hood, turn on the fan.

Do not place metallic objects such as knives, forks, spoons, and lids on the cooktop surface since they can get hot.

### **IMPORTANT INSTRUCTIONS FOR GLASS AND CERAMIC COOKTOPS**

Do Not Clean or Operate a Broken Cooktop. If cooktop should break, cleaning solutions and spillovers may penetrate the broken cooktop and create a risk of electric shock. Contact a qualified technician immediately.

Clean cooktop glass with caution. If a wet sponge or cloth is used to wipe spills on a hot cooking area, be careful to avoid a steam burn. Some cleaners can produce harmful fumes if applied to a hot surface.

Avoid scratching the cooktop glass with sharp objects.

### **IMPORTANT INSTRUCTIONS FOR USING YOUR OVEN**

Protective liners—Do not use aluminum foil, aftermarket oven liners, or any other materials or devices to line oven bottom, oven racks, or any other part of the appliance. Only use aluminum as recommended for baking, such as lining cookware or as a cover placed on food. Any other use of protective liners or aluminum foil may result in a risk of electric shock or fire or a short circuit.

Use care when opening oven door, lower oven door, or warmer drawer (some models). Stand to the side of the appliance when opening the door of a hot oven. Let hot air or steam escape before you remove or replace food in the oven.

Keep oven vent ducts unobstructed. Touching surfaces in this area when the oven is on may cause severe burns. Do not place plastic or heat-sensitive items on or near the oven vent. These items can melt or ignite.

Placement of oven racks - Always place oven racks in desired location while oven is cool. If rack must be moved while oven is hot, do not let potholder contact hot burner or element in oven. Use potholders and grasp the rack with both hands to reposition. Remove all cookware and utensils before moving the rack.

Do not use a broiler pan without its insert. Broiler pans and inserts allow dripping fat to drain away from the high heat of the broiler. Do not cover the broiler insert with aluminum foil; exposed fat and grease could ignite.

Do not cook food on the oven bottom. Always cook in proper cookware and always use the oven racks.

---

# 8

## IMPORTANT SAFETY INSTRUCTIONS

---

### IMPORTANT INSTRUCTIONS FOR CLEANING YOUR APPLIANCE

#### CAUTION

Before manually cleaning any part of the appliance, be sure all controls are turned off and the appliance is cool. Cleaning a hot appliance can cause burns.

Clean the appliance regularly to keep all parts free of grease that could catch fire. Do not allow grease to accumulate. Greasy deposits in the fan could catch fire.

Always follow the manufacturer's recommended directions for use of kitchen cleaners and aerosols. Be aware that excess residue from cleaners and aerosols may ignite causing damage and injury.

Clean ventilating hoods frequently - Grease should not be allowed to accumulate on hood or filter. Follow the manufacturer's instructions for cleaning vent hoods.

### IMPORTANT INSTRUCTIONS FOR SELF CLEANING OVENS

#### CAUTION

Before using self clean, remove the broiler pan, any food, utensils, and cookware from the oven, storage drawer or warming drawer (if equipped). Remove oven racks unless otherwise instructed.

Do not clean the oven door gasket. The door gasket is essential for a good seal. Care should be taken not to rub, damage, or move the gasket.

Do not use a protective coating to line the oven and do not use commercial oven cleaner unless certified for use in a self-cleaning oven."

Use the self clean cycle to clean only the parts listed in this manual.

Some birds are extremely sensitive to the fumes given off during the self clean cycle of any oven. Move birds to another well-ventilated room.

---

**IMPORTANT INSTRUCTIONS FOR SERVICE AND MAINTENANCE**

Do not repair or replace any part of the appliance unless specifically recommended in the manuals. All other servicing should be done only by a qualified technician. This reduces the risk of personal injury and damage to the appliance.

Always contact your dealer, distributor, service agent, or manufacturer about problems or conditions you do not understand.

Ask your dealer to recommend a qualified technician and an authorized repair service. Know how to disconnect the power to the appliance at the circuit breaker or fuse box in case of an emergency.

Remove the oven door from any unused oven if it is to be stored or discarded.

Do not touch a hot oven light bulb with a damp cloth. Doing so could cause the bulb to break. Handle halogen lights (if equipped) with paper towels or soft gloves. Disconnect the appliance or shut off the power to the appliance before removing and replacing the bulb.

**Important:** This appliance has been tested and found to comply with the limits for a class B digital device, pursuant to Part 18 of the FCC rules (United States) and ICES-001 (Canada). These limits are designed to provide reasonable protection against harmful interference in a residential installation. This unit uses and can radiate radio frequency energy and, if not installed and used in accordance with the instructions, may cause harmful interference to radio communications. However there is no guarantee that interference will not occur in a particular installation. If this unit does cause harmful interference to radio or television reception, which can be determined by turning the unit off and on, the user is encouraged to try to correct the interference by one or more of the following measures:

- Reorient or relocate the receiving antennae.
- Increase distance between unit and receiver.
- Connect the unit into an outlet or a circuit different from that to which the receiver is connected.

**WARNING**



California Residents: for cancer and reproductive harm information, visit [www.P65Warnings.ca.gov](http://www.P65Warnings.ca.gov)

---

# 10 COOKING RECOMMENDATIONS

## Bakeware

The material of bakeware affects how evenly and quickly it transfers heat from the pan to the food.

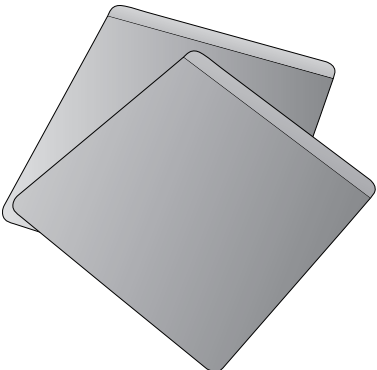
Material	Attributes	Recommendation
<p>Shiny metal bakeware</p> 	<p>Shiny, aluminum, and non-coated bakeware is the best for even heating. It is suitable for all baked goods.</p>	<p>Recommended cooking temperatures and times are based on shiny metal bakeware.</p>
<p>Dark metal bakeware</p> 	<p>Dark bakeware cooks hotter than shiny bakeware.</p>	<p>Reduce the cooking temperature by 25° F (13-14° C) when using dark bakeware.</p>
<p>Glass bakeware</p> 	<p>Glass bakeware cooks hotter than shiny bakeware.</p> <p>Glass is convenient, as the same piece of bakeware can be used for cooking, serving, and storing food.</p>	<p>Reduce the cooking temperature by 25° F (13-14° C) when using glass bakeware.</p>
<p>Insulated bakeware</p> 	<p>Insulated bakeware cooks cooler than shiny bakeware.</p> <p>Insulated bakeware is designed for baking in gas ovens.</p>	<p>Reduce the cooking temperature by 25° F (13-14° C) when using insulated bakeware.</p>

**Cooking Conditions**

Conditions in your kitchen can affect the performance of your appliance when cooking food.

Condition	Attributes	Recommendation
Aging cookware	As pans age and become discolored, cooking times may need to be reduced slightly.	If food is too dark or overcooked, use the minimum cook time in the recipe or packaging.  If food is too light or undercooked, use the middle to maximum cook time in the recipe or packaging.
High altitude	Air is drier and air pressure is lower.  Water boils at a lower temperature, and liquids evaporate faster.  Foods may take longer to bake.  Doughs may rise faster.	Adjust cooking temperature, cooking time, or recipes as needed.  Increase amount of liquid in baking recipes.  Increase cook time on cooktop. Cover dishes to reduce evaporation.  Increase bake time or oven temperature.  Reduce amount of baking soda or baking powder in recipe. Reduce rising time or punch down dough and allow it to rise twice.

**Cooking Results**

Small adjustments may fix a problem with food not being as done as you like or more done than you like.

Result	Recommendation
Food too light	Use the middle to maximum cook time recommended on packaging or recipe.
Food too dark	Use the minimum cook time recommended on packaging or recipe.

**Cooking Tips**

Use these additional tips to get the best results from your appliance.

Situation	Recommendation
<b>Baking</b>	
Rack placement	Follow the instructions in “Setting Oven Controls” starting on page 20.  When using only one rack, place the rack so the food is in the center of the oven.
Preheat	Fully preheat the oven before baking items like cookies, cakes, biscuits and breads. Insert food immediately after the beep.
Checking food	Use the window and oven light when checking food. Opening the door may reduce baking performance.
Bake or Convection Bake	Convection bake is the best function to use for baking on multiple racks. For best performance, see “Convection Bake” on page 25.
Food placement	Allow at least 2 inches (5 cm) of space between bakeware for proper air circulation.

# 12 COOKING RECOMMENDATIONS

---

Material	Recommendation
<b>Broiling / Roasting</b>	
Broiling pan	<p>For best results when broiling, use a broil pan with a broil pan insert designed to drain the fat from the food, help avoid spatter, and reduce smoking. The broiler pan will catch grease spills, and the insert helps prevent grease splatters.</p> <p>If a broiler pan and insert are not supplied with this appliance, they may be purchased from <a href="http://Frigidaire.com">Frigidaire.com</a>.</p>
<b>Convection Cooking</b>	
Convection attributes	<p>Convection cooking uses a fan to circulate hot air around the oven and food. It browns food more evenly and reduces hot spots in the oven.</p> <p>Convection saves time when using multiple racks or cooking several food items at once.</p>
Convection bake	<p>Reduce cooking temperature by 25° F (13-14° C) from the recipe unless the recipe is written for convection baking.</p> <p>Preheat the oven for best results.</p>

## How does induction work?

Most cooking uses radiant heat that must pass through the cookware to get food hot. Induction is a process that induces heat with an energy reaction. When each cooking zone is turned on, power goes to a coil under the cooktop. The powered coil creates an electromagnetic field. The electromagnetic field reacts with compatible materials in cookware, creating heat in the cookware itself. The power level controls the heating level, delivering precise results.

### Induction Benefits

Because heat starts in the cookware instead of the cooktop, induction offers several advantages.

**Cleaner cooking:** Because induction works by heating the cookware and not the cooktop, spills don't cook or stick to the surface.

**Cooler Cooktop:** An induction cooktop will be cooler when you remove cookware than a conventional cooktop would be. The only radiant heat produced in induction is from the cookware itself, so the kitchen stays cooler, too.

**Fast Heating:** Cookware will heat up faster than on a conventional electric cooktop. Pay close attention to avoid scorching food when starting to cook. You may need to use a lower setting for cooking food than you are used to.

**Precise Control:** The heat going into the cookware will change immediately when you change the setting of the cooking zone.

**Even Heating:** Cookware will typically heat more evenly on an induction cooktop, so you are less likely to have hot or cool spots in the cookware.

**Energy Efficiency:** Because induction creates heat directly in the pan, it uses less electricity than a conventional cooktop.

### Before Using Your Cooktop

Before using your cooktop for the first time, apply a ceramic cooktop cleaning cream (available in most hardware, grocery, and department stores) to the ceramic surface. Clean and buff with a clean paper towel. Cooktop cleaning creams leave a protective finish on the glass that will make cleaning easier when the cooktop is soiled from cooking and help prevent scratches and abrasions.

## CAUTION

Although induction cooking zones do not produce heat, **they can become hot from contact with hot cookware**. Burns may occur if a cooking zone or the surrounding area is touched before it has cooled to a safe temperature.

## Sounds

The magnetic field over the induction cooking zone may cause cookware to vibrate, creating a buzzing or humming noise. These sounds are not unusual, especially at high settings.

Cookware that is not perfectly flat on the bottom may vibrate slightly against the cooktop.

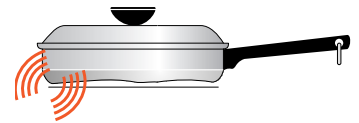

A loose handle may vibrate in its socket.

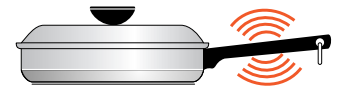

Multi-material cookware may allow small vibrations in its structure.



**Figure 1: Induction sounds**

Sounds are less likely to occur with heavier, higher quality cookware.

An induction cooktop may also produce faint clicking sounds from the electronic switches that maintain the desired cooking temperature. You may also hear a fan that cools the electronics inside the cooktop.

## NOTE

Be sure to read detailed instructions for induction cooktop cleaning in the "Care and Cleaning" section and "Before You Call" checklist section of this Use and Care Manual.

# 14 BEFORE SETTING SURFACE CONTROLS

## Using Proper Cookware

The size and type of cookware used will influence the heat setting needed for best cooking results. Be sure to follow the recommendations for using proper cookware as illustrated in Figure 2.

Check for flatness by rotating a ruler across the bottom of the cookware (see Figure 1). Cookware should have flat bottoms that make good contact with the entire surface of the heating element (see Figure 2).

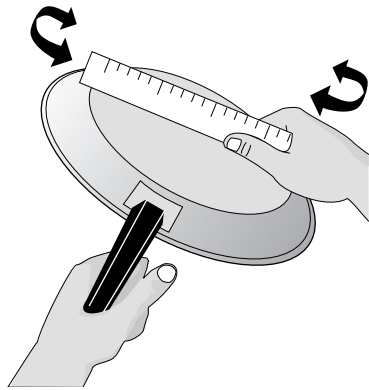

Figure 2: Testing cookware

## Cookware Material Types

Cookware material is especially important when using an induction cooktop. The cookware must contain magnetic iron or steel to work on an induction cooktop. Common materials for induction cookware include the following:

- **Stainless Steel** - Slow heat conductor. Durable, easy to clean, and resists staining. Some types of stainless steel will not work on an induction cooktop. Use the magnet test (see “Figure 4: Magnet test”) to check stainless steel cookware.
- **Cast Iron** - A slow heat conductor that retains heat very well. Cooks evenly once cooking temperature is reached.
- **Porcelain-enamel on metal** - Heating characteristics will vary depending on the base material. Porcelain-enamel on a compatible metal will work on an induction cooktop. Use the magnet test to check porcelain-enamel cookware.

To see if a piece of cookware will work on your induction cooktop, try to stick a magnet to it. If the magnet clings firmly to the bottom of the cookware, the cookware will work on your induction cooktop.

Cookware sold as induction-ready will often have a symbol printed on the bottom by the manufacturer.



Figure 3: Induction symbol

## The Magnet Test

To see if a piece of cookware will work on your induction cooktop, try to stick a magnet to it (see Figure 2).

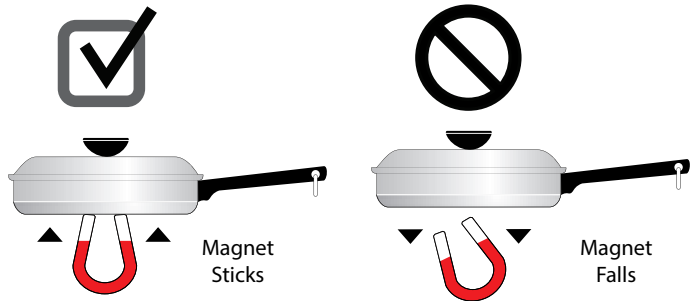

Figure 4: Magnet test

If the magnet clings firmly to the bottom of the cookware, it will work on your induction cooktop. If the magnet clings weakly or not at all, the cookware will not heat up on your induction cooktop.

## CAUTION

Proper cookware on an operating induction cooking zone will heat up very quickly. If an empty piece of cookware is left on an operating induction cooking zone, the rapid change in temperature may warp or damage the cookware.

**Pan Sensing**

When the cooktop is on, the cooking zones automatically detect when cookware is placed on the zone. The control for that zone will light up, making it easy to know which section of the control to use for that cooking zone.

Figure 5 shows conditions that can prevent pan detection.

If you remove a pan from an active cooking zone, the zone will turn off after 30 seconds.

If the cooktop does not detect cookware in any zone for 30 seconds, the whole cooktop will turn off.

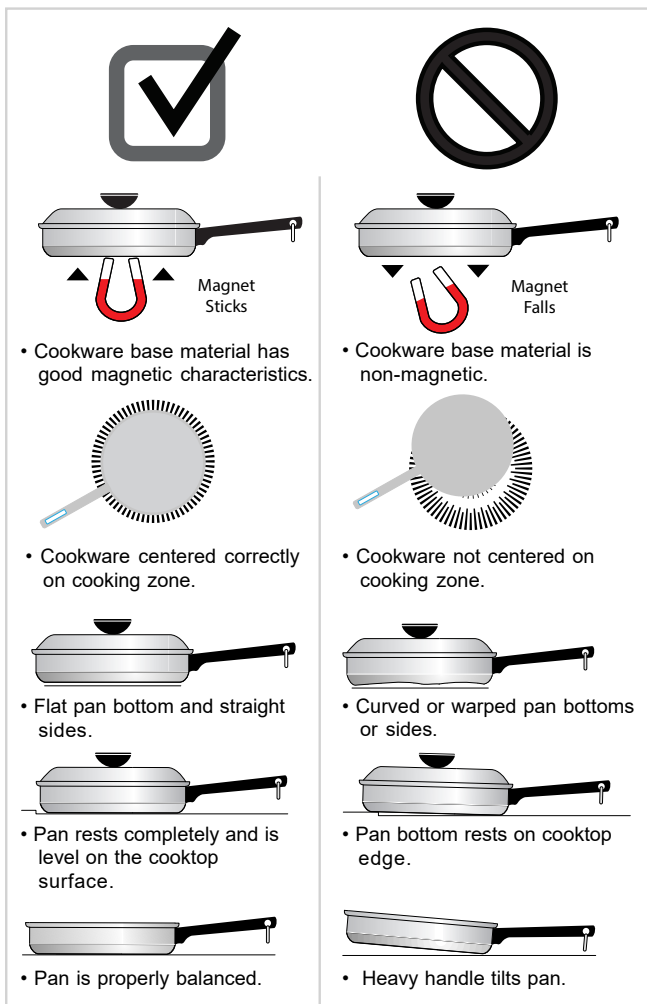

**Figure 5: Pan sensing conditions**

**Minimum and Maximum Pan Size**

The cooktop graphics are guides to minimum and maximum pan size for each cooking zone. For best results, use cookware that matches the size of the cooking zone.

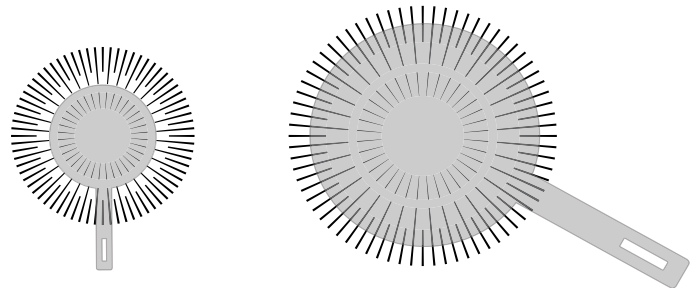
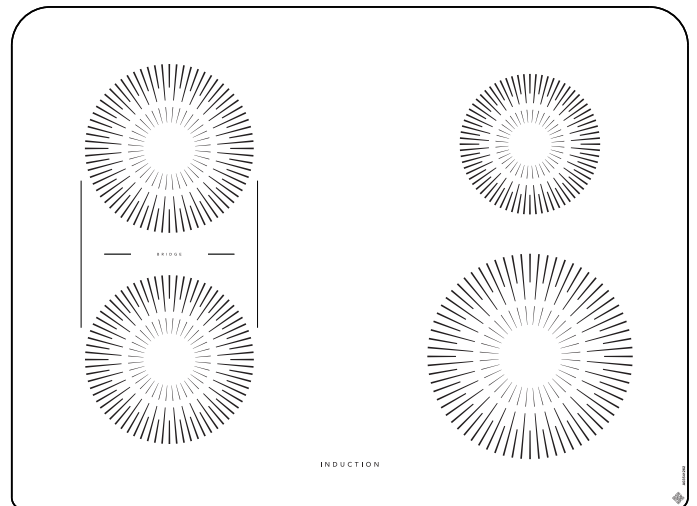

**Figure 6: Min / max pan size**

The inner ring on each cooking zone indicates the smallest pan size for the zone (Figure 8).

The outer ring on the cooktop graphic indicates the largest pan size for that zone (Figure 9).

Cookware that is too small for a zone may not activate the cookware detection sensor. Cookware that is much larger than a cooking zone will still cook, but may be slower and uneven. If your cookware is not a perfect match, it is best to use a zone a little smaller than the bottom of the cookware.



**Figure 7: Cookzone sizes**

### Hot Surface Indicator

When a cooking zone is turned off, it may remain hot due to contact with hot cookware. The Hot Surface Indicator will come on and remain visible until the cooking zone cools to a safe temperature.

#### HOT SURFACE

**Figure 8: Hot Surface indicator**

### CAUTION

- Although induction cooking zones do not directly generate heat, **they can become hot from contact with hot cookware**. Burns may occur if a cooking zone or the surrounding area is touched before it has cooled to a safe temperature.
- **Do not** place flammable items such as plastic salt and pepper shakers, spoon holders, or plastic wrapping on top of the range when it is in use. Heat radiating from cookware could cause these items to melt or ignite. Potholders, towels, or wooden spoons could catch fire if placed too close to hot cookware.
- **Do not** use aluminum foil to line any part of the cooktop. Improper installation of these liners may result in risk of electric shock or fire. If these items melt on the cooktop, they will damage the cooktop.

### Lock or Unlock the Cooktop

The control can be programmed to lockout the oven control keys and the oven door.



**Figure 9: Lock key**

#### To activate the oven lockout features:

1. Press and hold the **lock key** for 3 seconds.
2. The door lock mechanism will lock the door in about 15 seconds. Do not attempt to open door while the mechanism is active.
3. Once the controls are locked the with a lock icon will appear in the display.

#### To cancel the oven lockout feature:

1. Press and hold the lock key for 3 seconds.
2. The door lock mechanism will lock the door in about 15 seconds. Do not attempt to open door while the mechanism is active.
3. When the lock icon no longer displays, the oven control keypad will be available for use.

**NOTE:** If a control key is pressed when OVEN LOCKOUT is active, the control will triple beep indicating the key action is not available when the OVEN LOCKOUT feature is active.

**Moving Cookware on a Smooth Cooktop**

It's best to lift cookware before moving it on the ceramic glass cooktop. Cookware that has a rough or dirty bottom can mark and scratch the ceramic glass surface. Always start with clean cookware.

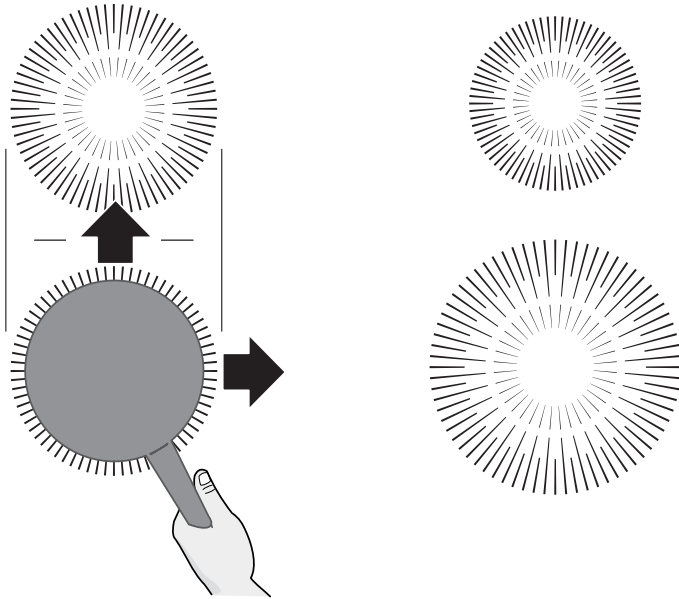

**Figure 10: Move cookware carefully on cooktop**

**Power Management**

Your induction cooktop has 2 generators and 4 cooking zones, depending on the model. Each generator powers 2 cooking zones. If you use more than one cooking zone on high power at the same time and they are on the same generator, the cooktop may need to manage power to the two cooking zones.

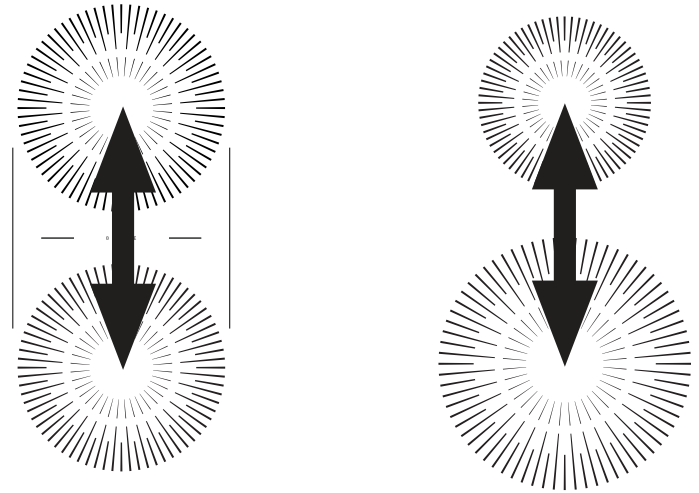

**Figure 11: Power management**

To get the best performance from your cooktop, start cooking on only one cooking zone. After the first piece of cookware has reached cooking temperature, then start cooking on the second cooking zone.

# 18

## BEFORE SETTING SURFACE CONTROLS

---

### Home Canning

Be sure to read and observe all the following points when home canning with your appliance. Check with the USDA (United States Department of Agriculture) Web site and be sure to read all the information they have available as well as follow their recommendations for home canning procedures.

- Use only a completely flat bottom canner with no ridges that radiate from the bottom center when home canning. Heat is spread more evenly when the bottom surface is flat. Use a straight-edge to check canner bottom.
- Make sure the diameter of the canner does not exceed 1 inch beyond the surface element markings or burner.
- It is recommended to use smaller diameter canners on electric coil and ceramic glass cooktops and to center canners on the burner grates.
- Start with hot tap water to bring water to boil more quickly.
- Use the highest heat setting when first bringing the water to a boil. Once boiling is achieved, reduce heat to lowest possible setting to maintain that boil.
- Use tested recipes and follow instructions carefully. Check with your local Cooperative Agricultural Extension Service or a manufacturer of glass jars for the latest canning information.
- It is best to can small amounts and light loads.

Do not leave water bath or pressure canners on high heat for an extended amount of time.

---

## Cooktop Controls

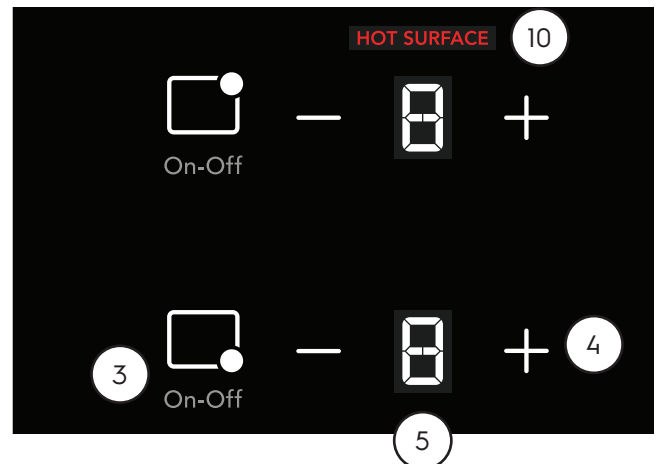
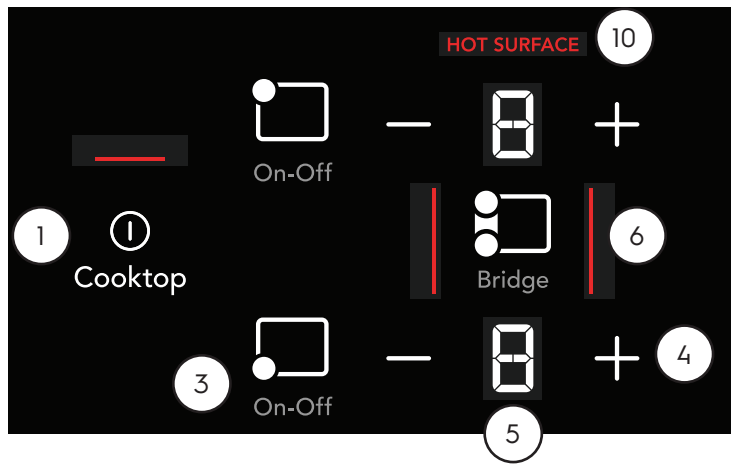

1. **Power:** Press to turn on or turn off the cooktop.
2. **Lock:** Lock the cooktop controls to prevent accidental activation of cooking zones (see page 26).
3. **Cooking Zone Power Button:** The rectangular controls (4 or 5 depending on the model) indicate cook zones. The circle indicates which cooking zone the control activates.
4. **Cooking Zone Power Adjust + / -:** Press + or - until the desired cooking level is shown (1-9 or P).
5. **Power Level Indicator:** Displays 1-9 or P to show the selected power level of the cooking zone.
6. **Bridge:** The two left cooking zones have the Bridge feature.  
The Bridge indicator is available on Zone 1 if both left cooking zones detect cookware. The Bridge function makes the two left cooking zones work together to heat a long piece of cookware, like a griddle.
7. **Timer Indicator:** Shows the time currently left on the timer.
8. **Timer On-Off:** Used to set or cancel the minute timer.
9. **Up/Down Arrows:** Used to adjust timer settings.
10. **Hot Surface Indicator:** Displays when either of the cooking zones on the same side is hot.

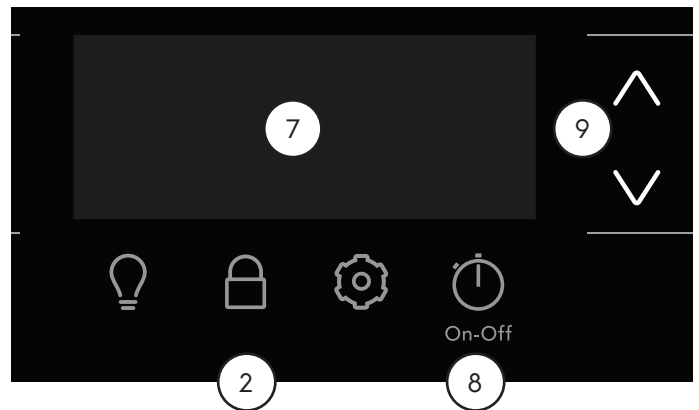

# 20 SETTING SURFACE CONTROLS

## Setting induction cooking zones

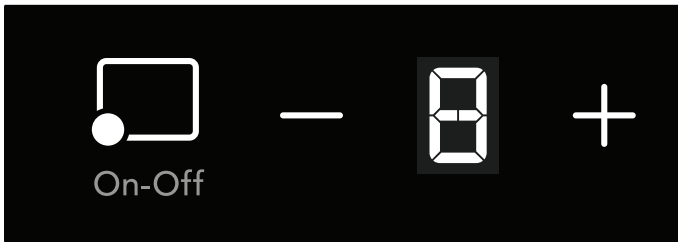

**Figure 12: Induction cooking zone control**

To operate an induction cooking zone:

1. Turn the cooktop on by pressing the **Power** key.
2. Place correctly sized cookware on the cooking zone. The Power Level Indicator for the cooking zone will show "--".
3. Press the **On-Off** key for the active cooking zone. The Power Level Indicator for the cooking zone will show "0".
4. Set the cooking zone to the desired level (refer to Table 1) by pressing **+** or **-** until the desired cooking level is shown.
5. When cooking is complete, turn the induction cooking zone OFF by pressing its **On-Off** key or the **Power** key before removing the cookware. If all of the zones are off, the cooktop will automatically power off in 30 seconds.

At any time, you can change the setting for an active cook zone by setting the number to the new setting.

### IMPORTANT

Do not leave empty cookware on an operating cooking zone. Cookware will heat very quickly and may be damaged or warped if left on the cooking zone empty.

### NOTE

A cooking zone will not become active without proper cookware in position. See "Pan Sensing" on page 15.

If the cooktop does not detect cookware within 30 seconds, it will turn off.

## Suggested induction cooking zone settings

Start most cooking operations on a higher setting and then turn to a lower setting to finish cooking.

The suggested settings found in Table 1 below are based on cooking with medium-weight stainless steel pans with lids. Settings may vary when using other types of pans.

**Electrolux Induction Recommendations**

	Temp Range	Power Level	Description
Keep Warm 145°-160°F	Low	1	Keep foods warm
	Medium Low	2-4	Continue cooking, poach, stew
Simmer 185 - 200°F	Medium	5-6	Maintain a slow boil, thicken sauces and gravies, steaming, cooking
	Medium High	7-8	Continue a rapid boil, fry, or deep fry
	High	9	Start most foods, maintain water at a boil, pan cooking, searing
	Power Boil	P	Start heating pans that contain large amounts of food or to bring pots of water to boil

**Table 1: Suggested induction cooking zone settings**

### NOTE:

- The size and type of the cookware used and the amount and type of food being cooked will influence the setting needed for best cooking results.
- The cooktop will remain on Power Boil for up to 10 minutes. After 10 minutes, the cooking zone will automatically change to the high (9) setting.
- The Hot Surface indicator (H) will show in the setting indicator when heat is detected in a cook zone that has been turned off. The indicator will remain on until the heated surface area has cooled sufficiently.

## Bridge Function

The Bridge function allows you to use an extra-long piece of cookware such as a griddle on the left side of your cooktop.

If one of the left cook zones is active and cookware is detected in both of the left zones, the bridge function becomes available.

1. Turn the cooktop on by pressing the **Power** key.
2. Place a griddle or other long piece of cookware on the left cooking zones. The Power Level Indicators for the cooking zones will show "--".
3. Press the **On-Off** key for one of the cooking zones. The Power Level Indicator for the cooking zone will show "0".
4. Touch the **Bridge** control to activate the bridge function. The LED indicators next to the control will turn red, and the cook zone setting for both of the bridged zones will become linked

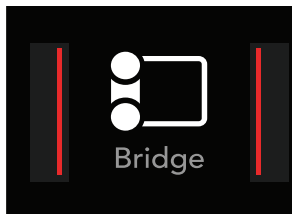

**Figure 13: Active bridge function**

5. Set the cooking zone to the desired level (refer to Table 1) by pressing **+** or **-** on the front left cooking zone until the desired cooking level is shown.

At any time, you can change the setting for the bridged cook zones by pressing the number of the new setting on the active control.

To deactivate the bridge function, press the **Bridge** control or deactivate one of the bridged cooking zones by pressing its **On-Off** key.

## Setting the Timer

The range has a timer function to remind you when food has been cooking for a specified amount of time.

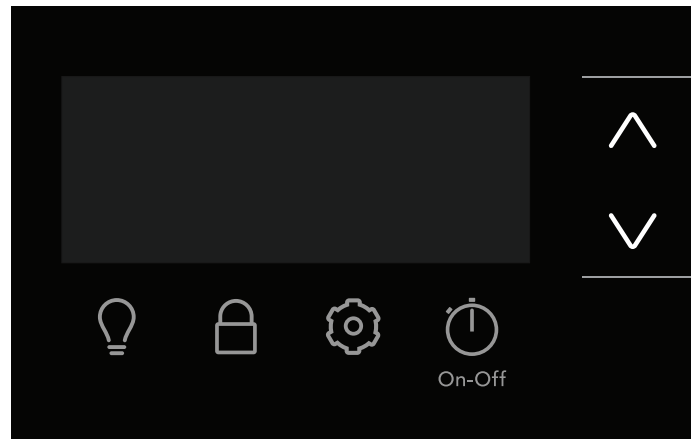

**Figure 14: Cooktop Timer**

To set the timer:

1. Press the Timer On/Off key (🕒) to activate the timer. The timer will show 00.
2. Press the **Up** and **Down** arrows to set the desired number of minutes. You can press and hold the **Up** or **Down** arrow to change the number of minutes faster.
3. Press the Timer On/Off key (🕒) again to start the countdown.

When the specified time has elapsed, "End" will show in the display, and a tone will sound. Press the **^**, the **v**, or the Timer On/Off key (🕒) to stop the signal.

At any time, you can adjust the remaining time with the **^** and **v** keys. Each press adds or subtracts one minute.

At any time, you can deactivate the timer by pressing the Timer On/Off key (🕒).

**Important:** When the timer stops or the tone sounds, the cooking zones will continue to operate. The timer does not affect the cooking zone settings in any way.

# 22 BEFORE SETTING OVEN CONTROLS

## Oven Vent Location

The oven is vented as shown below. When the oven is on, warm air is released through the vent. This venting is necessary for proper air circulation in the oven and good baking results. Do not block oven vent. Never close off the openings with aluminium foil or any other material. Steam or moisture may appear near the oven vent. This is normal.

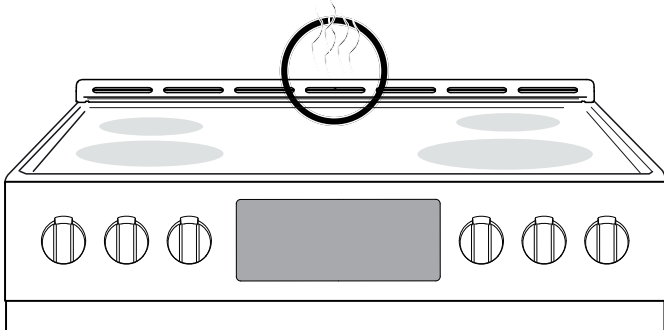

Figure 16: Oven vent

### WARNING

**Protective Liners** — Do not use aluminum foil or any other material or liners to line the oven bottom, walls, racks or any other part of the range. Doing so will alter the heat distribution, produce poor baking results, and possibly cause permanent damage to the oven interior. Improper installation of these liners may result in risk of electric shock or fire. During self clean, temperatures in the oven will be hot enough to melt foil.

### CAUTION

Always use pot holders or oven mitts when using the oven. When cooking, the oven interior, oven exterior, oven racks, and cooktop will become very hot which can cause burns.

Remove all oven racks before starting a self clean cycle. If oven racks are left inside the oven during a cleaning cycle, the slide ability of the oven racks may be damaged and all of the oven racks will lose their shiny finish.

To prevent possible damage to the oven, do not attempt to close the oven door until all the oven racks are fully positioned back inside the oven cavity.

## Types of Oven Rack

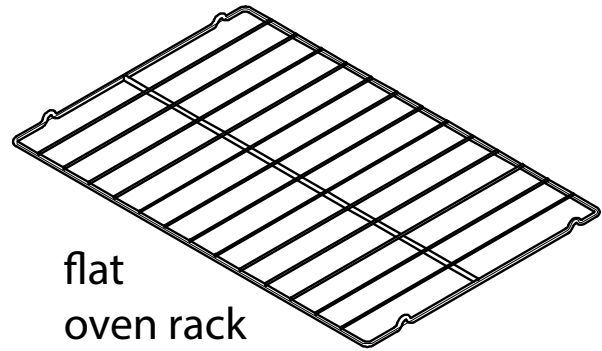

Figure 15: Oven rack types

**Flat oven racks** may be used for most cooking needs and may be placed in most oven rack positions.

## Removing, Replacing, and Arranging Flat or Offset Oven Racks

Always arrange the oven racks when the oven is cool.

To **remove** - Pull the oven rack straight forward until it reaches the stop position. Lift up front of oven rack slightly and slide out.

To **replace** - Place the oven rack on the rack guides on both sides of oven walls. Tilt the front of oven rack upward slightly and slide the oven rack back into place. Be sure oven racks are level before using.

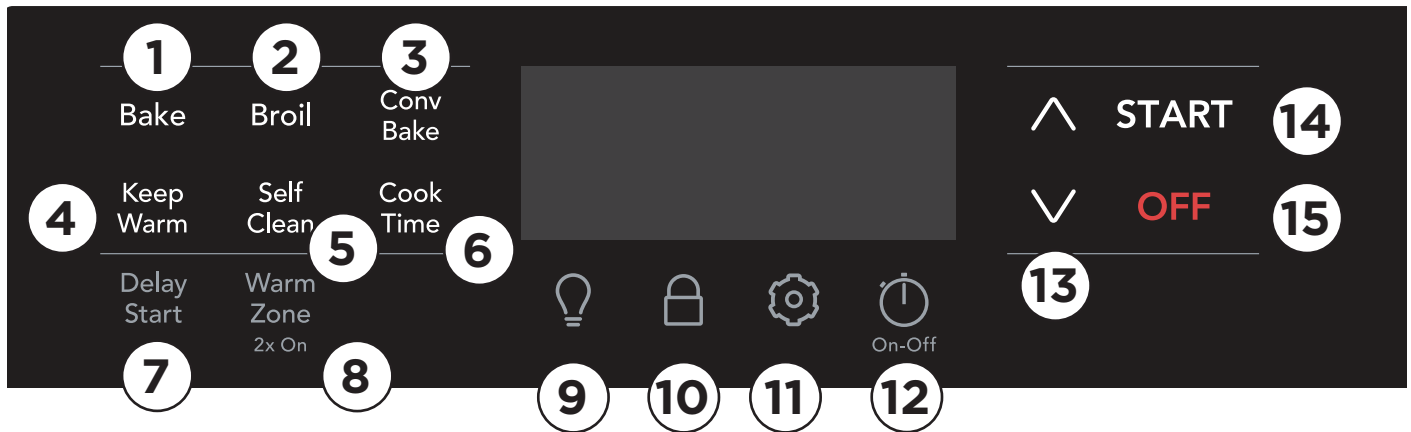

1. **Bake** is for delicate foods that need heat to rise and move gently in the oven.
2. **Broil** is for broiling and grilling foods under direct, high heat.
3. **Conv Bake** circulates the oven heat continuously for baking.
4. **Keep Warm** Use to keep cooked foods at serving temperature in the oven.
5. **Self Clean** starts a self-cleaning cycle.
6. **Cook Time** sets the oven to run for a period of time and then turn off.
7. **Delay Start** sets the oven to start after a specified period of time.
8. **Warm Zone** activates the surface warming zone.
9. **Oven Light** turns the interior light on and off at a touch and turns on automatically when oven door is open.
10. **Lockout** deactivates the control panel to prevent accidental key presses.
11. **Settings** is used to set user preferences for various control functions including:
  - **CLoC**: set clock to 12 or 24 hour mode.
  - **Hour**: change between the 12-hour energy saving feature or continuous bake.
  - **Aud**: set the volume of control keys or to operate in silent mode.
  - **F-C**: display temperatures in Fahrenheit or Celcius.
  - **rSEt**: reset all user preferences to original factory settings.
  - **uPo**: .adjust the oven temperature settings.
  - **E-SA**: .turn the 12-hour energy savings feature on or off.

12. **Timer On-Off** is used to set or cancel the minute timer.
13. **Up/Down Arrows** used to scroll to temperature and time settings.
14. **START** starts cooking functions and sets the clock.
15. **OFF** turns off all cooking functions.

**Table 3: Oven Modes**

Feature	Mode	Min.Temp/ Time	Max Temp/ Time
Bake		170°F (77°C)	550°F (288°C)
Broil		LO	HI
Conv Bake		170°F (77°C)	550°F (288°C)
Keep Warm		170°F (77°C)	200°F (93°C)
Clock	12 Hr.	1:00 Hr./Min.	12:59 Hr./Min.
	24 Hr.	0:00 Min	23:59 Hr./Min.
Timer On-Off		0:01 Min.	11:59 Hr./Min.

Note: An entry acceptance tone (1beep) will sound each time a key is touched (the oven lock key is delayed 3 seconds). An entry error tone (3 short beeps) will sound if the entry of the temperature or time is below the minimum or above the maximum settings for the feature.

# 24 SETTING OVEN CONTROLS

## Setting the Clock

It is recommended to always set the clock for the correct time of day before using the appliance.



**Note:** When the appliance is first plugged in or when the power supply to the appliance has been interrupted, the display will flash 12:00; in this case, skip to Step 4 of the instructions below.

To set the clock:

1. Press .
2. Press the **Up** or **Down** arrow until “CLoC” appears in the display.
3. Press **START**.
4. Press the **Up** or **Down** arrow until the correct time appears in the display. You can press and hold the **Up** or **Down** arrow to change the time faster.
5. Press **START**.

**NOTE:** The clock cannot be changed when the oven is set for cooking or self clean is active.

## Setting 12 Hour or 24 Hour display mode (Hour)

The clock display mode allows you to select 12 hr or 24 hr modes. The factory pre-set clock display mode is 12 hours.

To set 12 hr or 24 hr display mode:

1. Press .
2. Press the **Up** or **Down** arrow until “Hour” appears in the display.
3. Press **START**.
4. Press **UP or Down arrow** key to toggle between 12 hr and 24 hr setting.



5. Press **START** to accept the desired clock setting.

Display will return to the settings menu. After a few seconds, it will return to the time of day.

## Setting a silent control panel (Aud)

When selecting a function, an audible tone is heard each time a key is pressed. If desired, the control can be programmed for silent operation.

To set the controls for silent operation:

1. Press .
1. Press the **Up** or **Down** arrow until “Aud” appears in the display, then press **Start**.



2. Press the **Up** or **Down** arrow to toggle between “oFF” and “on”.



3. Press **START** to accept when the desired setting is displayed.

Display will return to the settings menu. After a few seconds, it will return to the time of day.

## Temperature display (F-C)

The electronic oven control is set to operate in Fahrenheit (°F) at the factory. You can change it to operate in Celcius (°C). The oven may be programmed for any temperature from 170°F to 550°F (77°C to 287°C).

To change the temperature to Celsius (°C) or from °C to °F:

1. Press .
2. Press Press the **Up** or **Down** arrow until until F-C appears.



3. Press **START**.
4. Press **Up and Down** arrows to toggle between F and C.



5. Press **START** to accept your choice.

Display will return to the settings menu. After a few seconds, it will return to the time of day.

## Adjust Oven Temperature (UPO)

Your appliance has been factory calibrated and tested to ensure an accurate baking temperature. For the first few uses, follow your recipe times and temperature recommendations carefully. If you think the oven is cooking too hot or too cool for your recipe times, you can adjust the control so the oven cooks hotter or cooler than the temperature displayed.

Important: Do not use oven thermometers such as those found in grocery stores to check the temperature settings inside your oven. These oven thermometers may vary as much as 20 to 40 degrees from actual temperatures.

The oven temperature may be increased as much as +35°F (+19°C) or decreased -35°F (-19°C) from the factory calibrated settings.

### To increase or decrease the oven temperature by 20°F:

1. Press .
2. Press the **Up** or **Down** arrow until “UPO” appears in the display.
3. Press **START**
4. Press the **Up** or **Down** arrow until the desired amount of temperature adjustment is shown.

The oven temperature may be increased as much as +35°F or decreased -35°F from the factory calibrated settings.

The oven temperature adjustment may be made if your oven control is set to display temperatures in °C (Celsius). Minimum and maximum settings for Celsius range from plus +19°C to minus -19°C.

5. Press **START** to accept change.

### Important note:

- Oven temperature adjustments will not change the Broil, Self Clean, or Keep Warm temperatures.

## Restore Factory Settings (rSet)

Your appliance was set with predetermined (default) oven control settings. Over time, users may have made changes to these settings. The following options may have been modified since the appliance was new.

- 12 or 24 hr display mode
- Continuous bake or 12-hour energy savings mode
- Silent or audible controls
- Oven temperature display (Fahrenheit or Celsius)
- Oven temperature adjustments (UPO)

### To restore oven control to factory default settings:

1. Press .
2. Press the **Up** or **Down** arrow until “rSet” appears in the display.
3. Press and hold **START** for three seconds. The control has been reset with the default settings.

## Continuous bake setting or 12-hour energy saving feature (E-SA)

The oven control has a built-in 12-hour energy saving feature that will shut off the oven if the oven is left on for more than 12 hours. The oven control can be programmed to override this feature for continuous baking.

### To change the continuous bake setting:

1. Press .
2. Press the **Up** or **Down** arrow until “E-SA” appears in the display.
3. Press **START**.
4. Press the **Up** or **Down** arrow to toggle between “12Hr” and “Cont.”
5. Press **START** to accept when the desired setting is displayed.

# 26 SETTING OVEN CONTROLS

## Setting the minute timer

The timer can be set for any amount of time from 1 minute to 11 hours and 59 minutes.



The minute timer can be used alone or while using any of the other oven features. If another feature is active when the minute timer is active, the minute timer will show in the display. To view information about other active features, press the key for that feature.

### Example: Setting timer for 15 minutes.

1. Press **Timer on-off** key:



On-Off

2. Press **Up or Down** arrows until the desired time appears in the display. You can press and hold the **Up or Down** arrow to change the time faster.



3. Press **START**. The timer will begin to count-down. When the set time ends, the display will show **End**.



To turn the timer off at any time, press the **Timer on-off** key.



On-Off

**NOTE:** The timer will beep three times and will continue to beep three times every minute until **Timer on-off** is pressed. The minute timer will not start or stop the cooking process.

## Operating oven light



The interior oven light will automatically turn on when the oven door is opened.

Press the oven light key on the control panel to turn the interior oven light on and off whenever the oven door is closed.

**NOTE:** For best baking results, do not leave oven light on while baking.

The interior oven light is located at the upper left rear wall of the oven interior. To change the interior oven light, see “Changing the oven light” in the Care & cleaning section.

## Oven Lock



The control can be programmed to lockout the surface and oven control keys and lock the oven door.

### To activate the lockout feature:

1. Press and hold the **lock key** for 3 seconds.
2. The door lock mechanism will lock the door in about 15 seconds. Do not attempt to open door while the mechanism is active.
3. Once the controls are locked, “L” will display in the surface cooking zones.

### To cancel the lockout feature:

1. Press and hold the **lock key** for 3 seconds.
2. The door lock mechanism will unlock the door in about 15 seconds. Do not attempt to open door while the mechanism is active.
3. When the lock icon no longer displays, the oven control keypad will be available for use.

**NOTE:** If a control key is pressed when Oven Lock is active, the control will triple beep indicating the key action is not available when the Oven Lock feature is active.

## Setting Bake

Bake cooks with heat that rises from the oven bottom. The heat and air circulate naturally in the oven. A reminder tone will sound indicating when the set bake temperature is reached and to place the food in the oven. The convection fan will turn on in preheat and then cycle on and off as needed during baking.

Bake may be set for any oven temperature between 170°F (77°C) to 550°F (288°C)



### CAUTION

Always use pot holders or oven mitts when using the oven. When cooking the oven interior, oven racks, and cooktop will become very hot which can cause burns.

### Baking tips

- Fully preheat the oven before baking items like cookies, cakes, biscuits and breads.
- Use the convection bake function for best results when baking cookies on multiple racks.
- Bake is the best function to use for baking cakes.
- For best results when baking layer cakes using two oven racks, place racks in positions 2 and 5 and place pans as shown in Figure 27.
- When using any single rack for baking cookies, cakes, biscuits, or muffins use rack position 3.
- Allow at least 2 inches (5 cm) of space between bakeware for proper air circulation.
- Dark or dull bakeware absorbs more heat than shiny bakeware, resulting in dark or over-browned foods. It may be necessary to reduce oven temperature or cook time to prevent over-browning of some foods.
- Dark pans are recommended for pies; shiny pans are recommended for cakes, cookies, and muffins.
- Do not open oven door often. Opening the door will reduce the temperature in the oven and may increase cook time.
- Do not leave oven light on while baking.



### IMPORTANT

The oven will bake no longer than 12 hours. If you wish to bake for a longer period, see “Changing between continuous bake setting or 12 hour energy saving” on page 21 for detailed information.

#### To set Bake for (default) oven temperature of 350°F:

1. Press **Bake**. 350° will appear in the display.

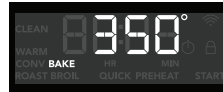

2. Press **START**.

To cancel Bake at any time, press **OFF**.

#### To change the oven temperature to 425°F when the oven is baking:

1. Press **Up arrow** to scroll to new temperature of **425** and release arrow key.



2. Press **START**.

**NOTE:** If **START** is not pressed the temperature will revert to the previous setting.

To cancel Bake at any time, press **OFF**.

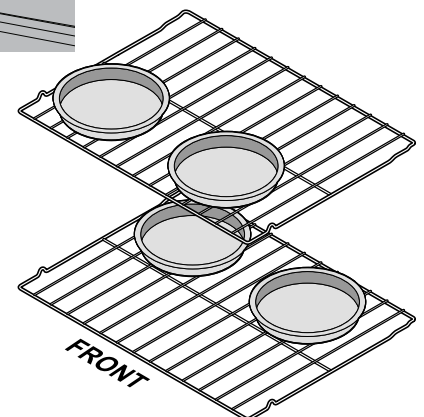
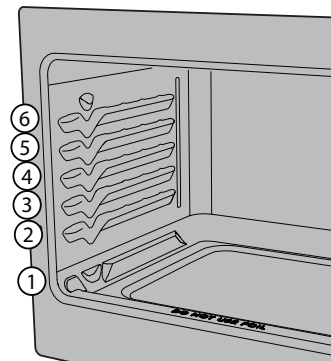

# 28 SETTING OVEN CONTROLS

## Convection Bake

Convection Bake uses a fan to circulate the oven's heat uniformly around the oven. This improved heat distribution allows for even cooking and browning results. Heated air flows around the food from all sides. The convection fan will turn on in preheat and remain on during baking.

Convection bake may be set for any oven temperature between 170°F (77°C) and 550°F (288°C).

### Benefits of convection cooking include:

- Multiple rack baking.
- Foods may cook faster, saving time and energy.

### Baking tips

- Fully preheat the oven before baking items like cookies, cakes, biscuits and breads.
- When baking cakes using two oven racks place bakeware in positions 2 and 5 and place bakeware as shown in Figure 29.
- When using any single rack for baking cookies, cakes, biscuits or muffins, use rack position 3.
- Unless the recipe is written for convection cooking, use Conv Convert to reduce oven temperature from the recipe's recommended oven temperature.
- Dark or dull bakeware absorbs more heat than shiny bakeware, resulting in dark or over-browned foods. It may be necessary to reduce oven temperature or cook time to prevent over-browning of some foods.
- Dark pans are recommended for pies; shiny pans are recommended for cakes, cookies, and muffins.
- Do not open oven door often. Opening the door will reduce the temperature in the oven and may increase cook time.
- Do not leave oven light on while baking.

### To set convection bake with a default oven set temperature of 325°F:

1. Press **Conv Bake**.
2. Conv Bake and 325° will appear in the display.



3. Press **START**. The convection fan will turn on and stay on during the cooking process.

To cancel convection bake at any time, press **OFF**.

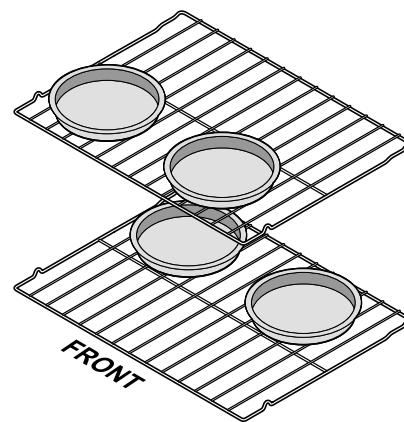
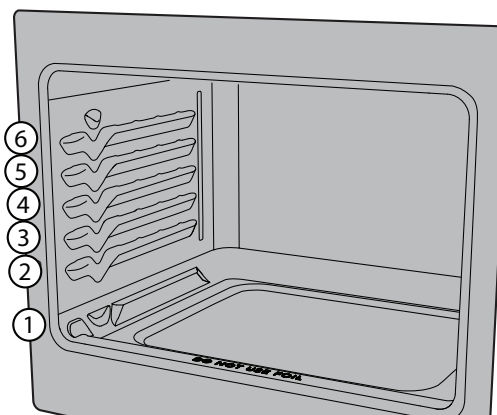

## CAUTION

Always use pot holders or oven mitts when using the oven. When cooking the oven interior, oven racks, and cooktop will become very hot which can cause burns.

## Setting Broil

Use the broil function to cook foods that require direct exposure to radiant heat for optimum browning results. Broiling may produce smoke.

If smoke is excessive, place food further away from the flames.



### WARNING

Should an oven fire occur, leave the oven door closed and turn off the oven. If the fire continues, use a fire extinguisher. Do not put water or flour on the fire. Flour may be explosive and water can cause a grease fire to spread and cause personal injury.



### CAUTION

Always use pot holders or oven mitts when using the oven. When cooking, the oven interior, oven racks, and cooktop will become very hot which can cause burns.



### IMPORTANT

Broiler pans and inserts allow the grease to drain away from the high heat of the broiler. Do not use the pan without the insert. Do not cover the insert with foil – the exposed grease could ignite.

**OPEN DOOR BROIL SHUTOFF:** If the oven door is left open during Broil for more than 3 minutes, an alarm will sound to notify the user to close the oven door. If the door is not closed, the oven will turn off within 30 seconds of the open door alarm.

**To set broil with the default broil temperature of 550°F:**

1. Arrange the oven racks when cool.
2. Position bakeware in oven.
3. Press **Broil**. “HI” will show in the display.
4. Press **Up or Down** arrows to select **HI** or **Lo**.
5. Press **START**.
6. For optimum browning results, preheat oven for 2 minutes before adding food. Broil with oven door **closed**.
7. Broil on one side until food is browned; turn and broil other side until done to your satisfaction.
8. When finished broiling, press **OFF**.

To cancel broil at any time, press OFF.

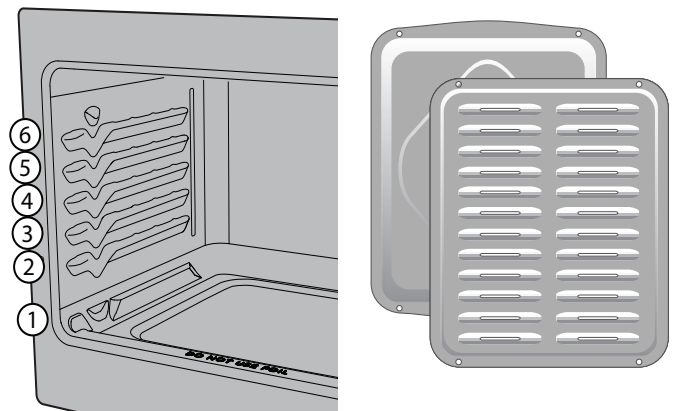

### NOTE

If a broiler pan and insert are not supplied with this appliance, they may be purchased from [www.frigidaire.com](http://www.frigidaire.com)

# 30 SETTING OVEN CONTROLS

## Important notes:

- Always arrange oven racks when the oven is cool.
- Broil with oven door closed. If broiling with door open, an alarm will sound alerting you to close the door. If left open, the Broil function will be canceled.
- For best results when broiling, use a broil pan with broil pan insert designed to drain the fat from the food and help avoid spatter and reduce smoking.
- When broiling, always pull the oven rack out to the stop position before turning or removing food.
- If a broiler pan and insert are not supplied with this appliance they may be purchased from [www.frigidaire.com](http://www.frigidaire.com).

**Table 4: Broil recommendations**

Food	Rack Position	Temperature	Cook time minutes		Internal Temperature	Doneness
			1st side	2nd side		
Steak 1" thick	6	550°F (288°C)	5	4	140°F (60°C)	Rare*
Steak 1" thick	5 or 6	550°F (288°C)	6	5	145°F (63°C)	Medium
Steak 1" thick	5 or 6	550°F (288°C)	7	6	170°F (77°C)	Well
Pork Chops 3/4" thick	5	450°F (232°C)	12	10	145°F (63°C)	Well
Chicken bone-in	4	450°F (232°C)	20	10	165°F (74°C)	Well
Chicken boneless	5	450°F (232°C)	8	6	165°F (74°C)	Well
Fish	5	550°F (288°C)	as directed		145°F (63°C)	Well
Shrimp	4	550°F (288°C)			145°F (63°C)	Well
Hamburger 1" thick	4	550°F (288°C)	6	5	145°F (63°C)	Medium
Hamburger 1" thick	4	550°F (288°C)	7	6	160 °F (71°C)	Well

\* The U.S. Department of Agriculture states, "Rare fresh beef is popular, but you should know that cooking it to only 140°F (60°C) means some food poisoning organisms may survive." (Source: Safe Food Book, Your Kitchen Guide) The lowest temperature recommended by the USDA is 145°F (63°C) for medium rare fresh beef. For well done 170°F (77°C). Allow cooked meat to rest for at least 3 minutes before serving.

NOTE: Broiling is direct heat cooking and will produce some smoke. If smoke is excessive, place food further away from element. Always watch foods carefully to prevent burning.

## Self Clean

Self Clean cleans with very high temperatures (well above normal cooking temperatures), eliminating soils completely or reducing them to very fine powdered ashes you can wipe away afterwards with a damp cloth.

This function can be programmed for clean times between 2 and 4 hours.

Before starting self clean read all following caution and important statements before starting a self clean cycle

### CAUTION

- Do not leave small children unattended near appliance. During self clean cycle, the outside of the oven can become very hot and cause burns if touched.
- Do not line the oven walls, racks, oven bottom, or any part of the range with aluminum foil. This will cause permanent damage to the oven interior and destroy heat distribution, and will melt to the oven interior.
- Do not force the oven door open. This will damage the automatic door locking system. Use caution when opening the oven door after the self clean cycle ends. The oven may still be very hot and cause burns. To avoid possible burns, stand to side of oven when opening door to allow steam or hot air to escape.
- The health of some birds is extremely sensitive to fumes given off during the self clean cycle of any range. Move birds to a well ventilated room.

### Important notes:

- Completely remove all oven racks and any accessories from oven cavity to avoid damage to oven racks. If the oven racks are not removed they may discolor.
- Remove all items from the oven and cooktop including cookware, utensils, and any aluminum foil. Aluminum foil will not withstand high temperatures from a self clean cycle and will melt.

- Do not spray oven cleaners or oven protective coatings in or around any part of the oven interior. Clean any soil from the oven frame, the door liner outside the oven door gasket, and the small area at the front center of the oven bottom (Figure 35). These areas heat sufficiently to burn soil on. Clean using soap and water prior to starting Self Clean.
- Remove any excessive spills. Any spills on the oven bottom should be wiped up and removed before starting a self clean cycle. To clean use hot, soapy water and a cloth. Large spills can cause heavy smoke or fire when subjected to high temperatures.
- Do not allow food spills with high sugar or acid content (such as milk, tomatoes, sauerkraut, fruit juices, or pie fillings) to remain on the surface as they may leave a dull spot even after cleaning.
- Do not clean the oven door gasket. The woven material in the gasket is essential for a good seal. Care should be taken not to rub, damage, or remove the oven door gasket. Doing so could cause damage to the door gasket and compromise the performance of the oven.

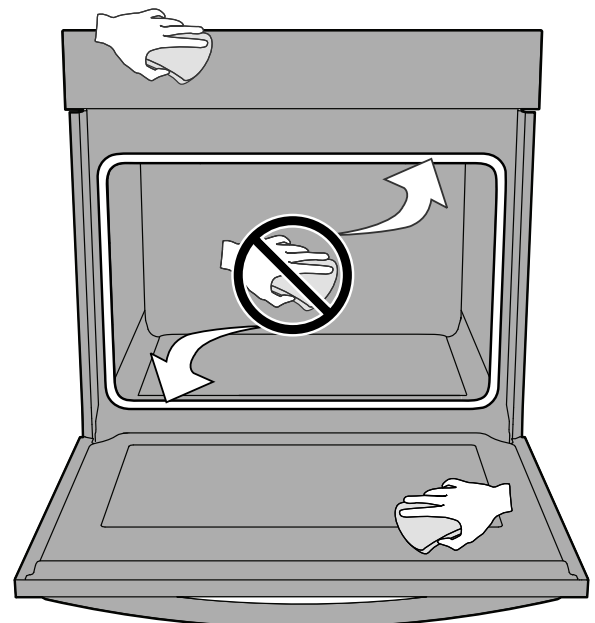

# 32 SETTING OVEN CONTROLS

- The kitchen area should be well ventilated using an open window, ventilation fan, or exhaust hood during the first self clean cycle. This will help eliminate the normal odors.
- Do not attempt to open the oven door when the OVEN LOCK indicator light is flashing. Allow about 15 seconds for the motorized door latch mechanism to completely lock or unlock the oven door.
- When the clean time finishes, the oven door will remain locked until the range has cooled sufficiently. In addition to the clean time that was programmed, you must allow about 1 additional hour for the oven to cool before you will be able to open the oven door.

## Setting Self Clean

### To set self clean:

Be sure the oven is empty and all oven racks are removed. Remove all items from the oven. Be sure oven door is completely closed.

1. Press **Self Clean**. The warning to remove **RACKS** will flash in the display to remind you that oven racks should be removed before a self clean. The default 3 hour clean time will appear in the display.

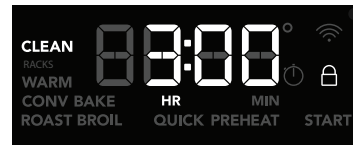

2. Press **START** to activate self clean.
3. The **RACKS** warning will end and Self Clean will start. The motor door lock will begin locking the oven door. Do not open the oven door while the lock motor is running or when any locking indicators or displays are showing. The oven door is completely locked in about 15 seconds.
  - Once the oven door has locked, **CLEAN** will appear in the display indicating self clean has started.
  - Do not force the oven door open when self-clean is active. This can damage the automatic door-locking system.
  - Use caution when opening the door after self-clean cycle is complete; the oven may still be very hot.
4. When self clean is finished: **CLEAN** message will turn off, and **Hot** will appear in display window.

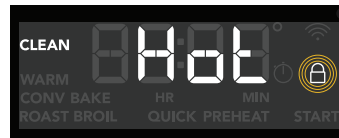

5. Once the oven has cooled down (about 1 hour) and **Hot** is no longer displayed, the oven door may be opened.

**CAUTION:** To avoid possible burns, use care when opening the oven door after the self-cleaning cycle. Stand to the side of the oven when opening the door to allow hot steam and air to escape.

When the oven interior has completely cooled, wipe away any residue or powdered ash with a damp cloth or paper towel.

### Cook Time

Use Cook Time to set the amount of time needed for most oven functions. The oven will turn on immediately (or after a specified delay) and stop automatically after the set cook time ends.

#### To set Cook Time:

1. Press **Cook Time**. The display will show a time of 0:00 (0 hours and 00 minutes).
2. Press **Up or Down** arrows until the desired time for cooking shows in the display. You can press and hold the **Up** or **Down** arrow to change the time faster.
3. Press **START**. The timer will start counting down..
4. When the time runs out, the display will show "End" and the oven will turn off.

To turn off the oven before the time runs out, press **OFF**.

### Delay Start

Delay Start allows a delayed starting time only for the Bake function. Prior to setting a delay start, be sure the time of day is set correctly. The maximum delay for a Delay Start is one hour.

#### To set Cook Time:

1. Choose the Bake and set the temperature.
2. Set a Cook Time if desired.
3. Press **Delay Start**. The display will show a time of 0:00 (0 hours and 00 minutes).
4. Press **Up or Down** arrows until the desired time delay shows in the display. You can press and hold the **Up** or **Down** arrow to change the time faster.
5. Press **START**. The timer will start counting down.
6. When the time runs out, the chosen cooking function will start. If a Cook Time was set, the remaining cook time will show in the display.

To stop the Delay Start timer at any time, press **OFF**.

### Keep Warm

Keep Warm should only be used with foods that are fully cooked and at serving temperatures. Keep Warm will keep foods warm and ready for serving at 170° F (77°C). If needed, arrange oven racks and place cooked food in oven.

#### To set Keep Warm:

1. Press **Keep Warm**. (If no other keys are touched within 25 seconds the request for Warm will clear.)



2. Press **START**. Keep Warm will automatically turn on and remain on for 3 hours or until cancelled.

To turn off Keep Warm at any time, press **OFF**.

# 34 CARE AND CLEANING

Remove spills and any heavy soiling as soon as possible. Regular cleaning will reduce the difficulty of major cleaning later.

## CAUTION

Before cleaning any part of the appliance, be sure all controls are turned off and the appliance is cool.

If ammonia or appliance cleaners are used, they must be removed and the appliance must be thoroughly rinsed before operating. Follow manufacturer's instructions and provide adequate ventilation.

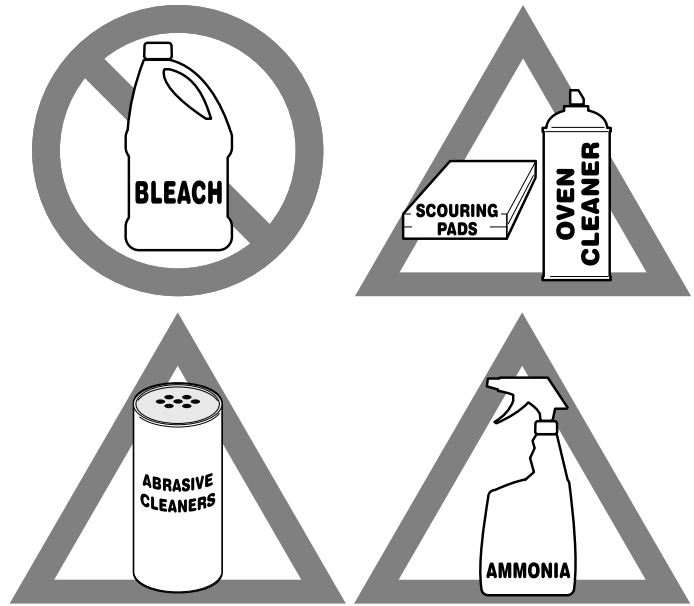

Figure 17: Use cleaners with caution

Surface or Area	Cleaning Recommendation
Aluminum and vinyl	Using a soft cloth, clean with mild dish detergent and water. Rinse with clean water, dry and polish with a soft, clean cloth.
Painted and plastic control knobs Painted body parts Painted decorative trims	Using a soft cloth, clean with mild dish detergent and water or a 50/50 solution of vinegar and water. Rinse with clean water, dry and polish with a soft, clean cloth. Glass cleaners may be used, but do not apply directly to surface; spray onto cloth and wipe.
Control panel	Using a soft cloth, clean with mild dish detergent and water or a 50/50 solution of vinegar and water. Do not spray liquids directly on the oven control and display area. Do not use large amounts of water on the control panel - excess water on the control area may cause damage to the appliance. Do not use other liquid cleaners, abrasive cleaners, scouring pads, or paper towels - they will damage the finish.
Control knobs	Using a soft cloth, clean with mild dish detergent and water or a 50/50 solution of vinegar and water. To remove control knobs: turn to the OFF position, grasp firmly, and pull off the shaft. To replace knobs after cleaning, line up the OFF markings and push the knobs into place.
Stainless Steel	Using a soft cloth, clean with mild dish detergent and water or a 50/50 solution of vinegar and water. Rinse with clean water, dry with a soft clean cloth. Do not use cleaners containing abrasives, chlorides, chlorine, or ammonia.
Smudge Proof™ Stainless Steel Black Stainless Steel	Using a soft cloth, clean with mild dish detergent and water or a 50/50 solution of vinegar and water. Rinse with clean water, dry with a soft clean cloth. Do not use appliance cleaner, stainless steel cleaner, or cleaner containing abrasives, chlorides, chlorine, or ammonia. These cleaners may damage the finish.

Surface or Area	Cleaning Recommendation
<p>Porcelain-enameled broiler pan and insert</p> <p>Porcelain door liner</p> <p>Porcelain body parts</p>	<p>Rinse with clean water and a damp cloth. Scrub gently with a soapy, non-abrasive scouring pad to remove most spots. Rinse with a 50/50 solution of clean water and ammonia. If necessary, cover difficult spots with an ammonia-soaked paper towel for 30 to 40 minutes. Rinse and wipe dry with a clean cloth. Remove all cleaners or future heating could damage the porcelain. Do not allow food spills with a high sugar or acid content (milk, tomatoes, sauerkraut, fruit juices or pie filling) to remain on porcelain surfaces. These spills may cause a dull spot even after cleaning.</p>
<p>Manual clean oven interior</p>	<p>The oven interior is porcelain coated and safe to clean using oven cleaners. Always follow manufacturer's instructions for cleaners. After cleaning, remove any oven cleaner or the porcelain may become damaged during future heating. Do not spray oven cleaner on any electrical controls or switches. Do not spray or allow oven cleaner to build up on the oven temperature sensing probe. Do not spray cleaner on oven door trim, door gasket, plastic drawer glides, handles or any exterior surfaces of the appliance.</p>
<p>Self-cleaning oven interior</p>	<p>Before setting a self-clean cycle, clean soils from the oven frame, areas outside the oven door gasket, and the small area at the front center of the oven bottom. See "Self Clean" on page 23.</p>
<p>Oven door</p>	<p>Use mild dish detergent and water or a 50/50 solution of vinegar and water to clean the top, sides, and front of the oven door. Rinse well. Glass cleaner may be used on the outside glass of the door. Ceramic smoothtop cleaner or polish may be used on the interior door glass. Do not immerse the door in water. Do not spray or allow water or cleaners to enter the door vents. Do not use oven cleaners, cleaning powders, or any harsh abrasive cleaning materials on the outside of the oven door.</p> <p>Do not clean the oven door gasket. The oven door gasket is made of a woven material which is essential for a good seal. Do not rub, damage, or remove this gasket.</p>
<p>Ceramic cooktop</p>	<p>See "Cooktop Cleaning" on page 36.</p>

# 36 CARE AND CLEANING

## Cooktop Maintenance

Consistent and proper cleaning is essential to maintaining your ceramic glass cooktop.

Prior to using your cooktop for the first time, apply a ceramic cooktop cleaning cream (available in most hardware, grocery, and department stores) to the ceramic surface. Clean and buff with a clean paper towel. This will make cleaning easier when soiled from cooking. Cooktop cleaning creams leave a protective finish on the glass to help prevent scratches and abrasions.

Sliding pans on the cooktop can cause metal markings on the cooktop surface. These marks should be removed immediately after the cooktop has cooled using cooktop cleaning cream. Metal marks can become permanent if not removed prior to future use.

Cookware (cast iron, metal, ceramic, or glass) with rough bottoms can mark or scratch the cooktop surface.

### Do not:

- Slide anything metal or glass across the cooktop.
- Use cookware with dirt or dirt build up on the bottom; always use clean cookware.
- Use your cooktop as a cutting board or work surface in the kitchen.
- Cook foods directly on the cooktop surface without a pan.
- Drop heavy or hard objects on the ceramic glass cooktop; they may cause it to crack.

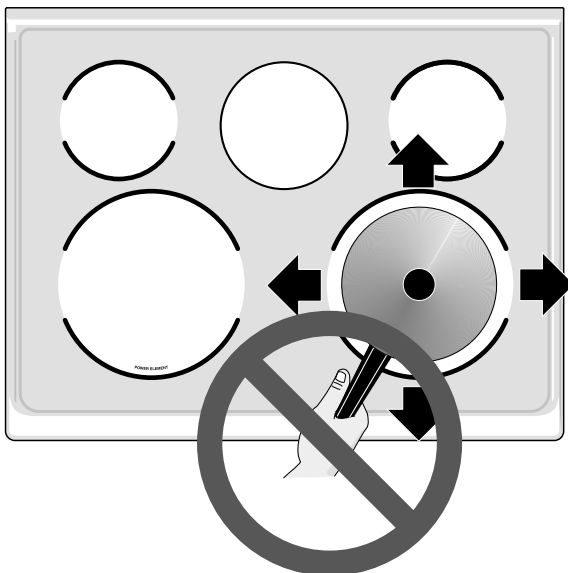

Figure 18: Cooktop care

## Cooktop Cleaning

### CAUTION

Before cleaning the cooktop, be sure the controls are turned to OFF and the cooktop is cool. The glass surface could be hot from contact with hot cookware, and burns may occur if the glass surface is touched before it has cooled sufficiently.

### WARNING

Do not use a cooktop cleaner on a hot cooktop. The fumes can be hazardous to your health, and can chemically damage the ceramic-glass surface.

### For light to moderate soil:

For light to moderate soil: Apply a few drops of cooktop cleaning cream directly to the cooktop. Use a clean paper towel to clean the entire cooktop surface. Make sure the cooktop is cleaned thoroughly, leaving no residue. Do not use the towel you use to clean the cooktop for any other purpose.

### For heavy, burned on soil:

Apply a few drops of cooktop cleaning cream directly to the soiled area. Rub the soiled area using a non-abrasive cleaning tool, applying pressure as needed. Do not use the pad you use to clean the cooktop for any other purpose.

If soils remain, carefully scrape soils with a metal razor blade scraper held at a 30 degree angle to the surface. Finish cleaning with cooktop cleaning cream.

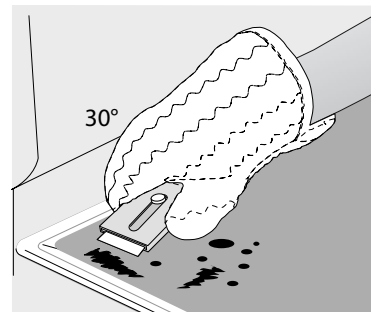

Figure 19: Cooktop cleaning

### IMPORTANT

Damage to the ceramic glass cooktop may occur if you use an abrasive type cleaning pad. Only use cleaning products that have been specifically designed for ceramic glass cooktops.

## General Cleaning

Refer to the table at the beginning of this chapter for more information about cleaning specific parts of the oven.

### Follow these cleaning precautions:

- Allow the oven to cool before cleaning.
- Wear rubber gloves when cleaning the appliance manually.

Remove soils using hot, soapy water. Do not allow food spills with a high sugar or acid content (such as milk, tomatoes, sauerkraut, fruit juices or pie filling) to remain on the surface as they may cause a dull spot even after cleaning. Remove spillovers and heavy soiling as soon as possible. Regular cleaning will reduce the effort required for major cleaning later.



## CAUTION

Before manually cleaning any part of the oven, be sure all controls are turned off and the oven is cool. The oven may be hot and can cause burns.

Remove all racks and accessories from the oven before cleaning.

Ammonia must be rinsed before operating the oven. Provide adequate ventilation.

## Aluminum Foil, Aluminum Utensils, and Oven Liners



## WARNING

Never cover any slots, holes, or passages in the oven bottom or cover an entire oven rack with materials such as aluminum foil. Doing so blocks air flow through the oven and may cause carbon monoxide poisoning. Aluminum foil linings may trap heat, causing a fire hazard.

- Protective liners—Do not use aluminum foil to line the oven bottom. The high heat of the oven can melt these materials to the oven cavity and ruin the oven. These types of materials can also reduce the effectiveness of the air circulation in the oven and produce poor baking results. Only use aluminum foil as recommended in this manual. Improper installation of these liners may result in risk of electric shock or fire.
- Aluminum utensils - The melting point of aluminum is much lower than that of other metals. Care must be taken when aluminum pots or pans are used.
- Oven racks - Do not use aluminum foil to cover the oven racks. Using a liner in the oven restricts the heat and air flow needed to obtain the best possible cooking results for any oven.

# 38 CARE AND CLEANING

## Replacing the Oven Light

### CAUTION

Be sure the oven is unplugged and all parts are cool before replacing the oven light.

The interior oven light is located at the rear of the oven cavity and is covered by a glass shield. The glass shield must be in place whenever the oven is in use.

### To replace the oven interior light bulb:

1. Turn electrical power off at the main source or unplug the appliance.
2. Remove interior oven light shield by turning a quarter turn counter-clockwise.
3. Replace bulb with a new T-4 type Halogen 25 watt appliance bulb.

### NOTE

Wear a cotton glove or use a paper towel when installing a new bulb. Do not touch the new bulb with your fingers when replacing. This will shorten the life of the bulb.

4. Replace glass oven light shield by rotating clockwise.
5. Turn power back on again at the main source (or plug the appliance back in).
6. Be sure to reset the time of day on the clock.

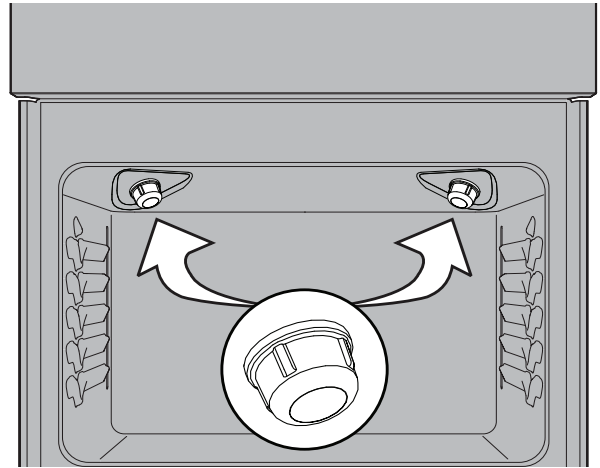

**Figure 21: Oven Halogen light**

## Removing and Replacing the Oven Door

### CAUTION

The door is heavy. For safe, temporary storage, lay the door flat with the inside of the door facing down.

### IMPORTANT

Special door care instructions - For safe, temporary storage, lay the door flat with the inside of the door facing down.

Most oven doors contain glass that can break. Do not hit the glass with pots, pans, or any other object. Scratching, hitting, jarring, or stressing the glass may weaken its structure, causing an increased risk of breakage at a later time. Do not close the oven door until all of the oven racks are fully in place.

#### To remove the oven door:

1. Open oven door completely, horizontal with floor (Figure 22).
2. Pull up the lock located on each hinge support toward front of the oven until the lock stops. You may have to apply a little upward pressure on the lock to pull it up (Figure 23).
3. Grasp the door by the sides, and close the door until the door frame makes contact with the unlocked hinges (Figure 24).
4. Pull the bottom of the door toward you while rotating the top of the door toward the appliance to completely disengage the hinge levers (Figure 25).

#### To replace the oven door:

1. Firmly grasp both sides of oven door along the door sides. Do not use the oven door handle (Figure 25).
2. Hold the oven door at the same angle as the removal position (Figure 24). Carefully insert the hinge levers into the oven frame until you feel the hinge levers are seated into the hinge notches. The hinge arms must be fully seated into the hinge notches before the oven door can be fully opened.
3. Fully open the oven door, horizontal with floor (Figure 22).
4. Push the door hinge locks up toward and into the oven frame on both left and right oven door hinges to the locked position (Figure 23).
5. Close the oven door.

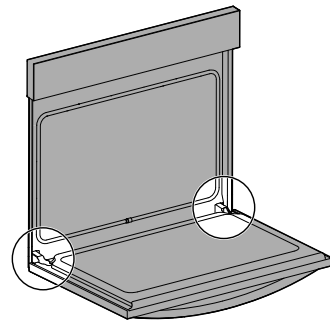

Figure 22: Door hinge location

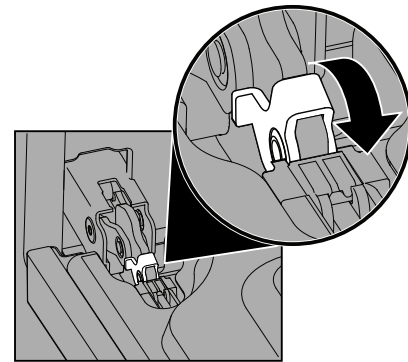

Figure 23: Door hinge lock

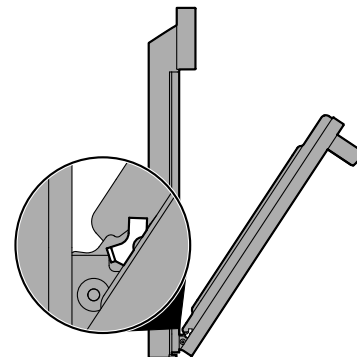

Figure 24: Removal position

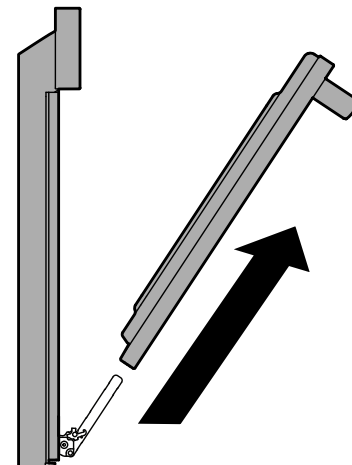







Figure 25: Remove door

# 40 BEFORE YOU CALL

## Oven Baking

For best cooking results, preheat the oven before baking cookies, breads, cakes, pies, pastries, etc. There is no need to preheat the oven for roasting meat or baking casseroles. The cooking times and temperatures needed to bake a product may vary slightly from your previously owned appliance.

Baking Problems and Solutions		
Baking Problems	Causes	Corrections
Cookies and biscuits burn on the bottom. 	Cookies and biscuits put into oven before oven is preheated.	Allow oven to preheat to desired temperature before placing food in oven.  Choose pan sizes that will permit at least 2" of air space
Cakes too dark on top or bottom 	Cakes put in oven before oven is preheated.  Rack position too high or too low.  Oven too hot.	Allow oven to preheat to the selected temperature before placing food in the oven.  Use proper rack position for baking needs.  Set oven temperature 25°F (13°C) lower than recommended.
Cakes not done in center 	Oven too hot.  Incorrect pan size.  Pan not centered in oven.  Glass cookware slow heat conductor.	Set oven temperature 25°F (13°C) lower than recommended.  Use pan size suggested in recipe.  Use proper rack position and place pan so there are at least 2" (5.1 cm) of space on all sides of pan.  Reduce temperature and increase cook time or use shiny bakeware.
Cakes not level. 	Oven not level.  Pan too close to oven wall or rack overcrowded.  Pan warped.  Oven light left on while baking.	Place a marked glass measuring cup filled with water on the center of the oven rack. If the water level is uneven, refer to the installation instructions for leveling the oven.  Use proper rack position and place pan so there are at least 2" (5.1 cm) of space on all sides of pan.  Do not use pans that are dented or warped.  Do not leave the oven light on while baking.
Foods not done when cooking time is over. 	Oven too cool.  Oven overcrowded.  Oven door opened too frequently.	Set oven temperature 25°F (13°C) higher than suggested and bake for the recommended time.  Be sure to remove all pans from the oven except the ones to be used for baking.  Open oven door only after the shortest recommended baking time.

Let us help you troubleshoot your concern! This section will help you with common issues. If you need us, visit our website, chat with an agent, or call us. We may be able to help you avoid a service visit. If you do need service, we can get that started for you!

**1-800-374-4432 (United States)**  
**Frigidaire.com**

**1-800-265-8352 (Canada)**  
**Frigidaire.ca**

Problem	Cause / Solution
Entire appliance does not operate	Appliance not connected. Make sure power cord is plugged properly into outlet. Check your fuse box or breaker box to make sure the circuit is active.  Electrical power outage. Check house lights to be sure. Call your local electric company for service outage information.

<b>Oven Problems</b>	
Problem	Cause / Solution
Poor baking results.	Many factors affect baking results. Use proper oven rack position. Center food in the oven and space pans to allow air to circulate. Preheat the oven to the set temperature before placing food in the oven. Try adjusting the recipe's recommended temperature or baking time. See "Adjusting the Oven Temperature" on page 26 if you feel the oven is too hot or too cool.
Flames inside oven or smoking from oven vent.	Excessive spills in oven. Grease or food spilled onto the oven bottom or oven cavity. Wipe up excessive spills before starting the oven. If flames or excessive smoke are present when using broil, see "Using the Broil Feature" on page 22.
Oven smokes excessively when broiling.	Incorrect setting. Follow the "Using the Broil Feature" instructions on page 22.  Meat too close to the broil element or burner. Reposition the broil pan to provide proper clearance between the meat and broil element or burner. Remove excess fat from meat. Cut remaining fatty edges to prevent curling, but do not cut into lean.  Grease build up on oven surfaces. Regular cleaning is necessary when broiling frequently. Grease or food splatters will cause excessive smoking.
Oven control panel beeps and displays any F or E code error.	Oven control has detected a fault or error condition. To clear the error, press the OFF key on the control panel. Once the error code is cleared, try the bake or broil function. If the F or E code error repeats, turn off the power to appliance, wait 5 minutes, and then repower the appliance. Set the clock with correct time of day. Try the bake or broil function again. If the fault recurs, press the OFF key to clear.
Oven portion of appliance does not operate.	Be sure the regulator gas valve is turned to ON. See installation instructions.  The time of day is not set. The clock must be set in order to operate the oven. See "Setting Clock" on page 15.  Be sure the oven controls are set properly for the desired function. See "Oven Control Features" starting on page 14 and review instructions for the desired cooking function in this manual or see "Entire appliance does not operate." in this checklist.
Convection fan does not rotate.	Oven door is open. The convection fan will turn off if the oven door is opened when convection is active. Close the oven door.  On gas models, the convection fan will begin to rotate about 6 minutes into the preheating process.

# 42 BEFORE YOU CALL

<b>Cooktop Problems</b>	
<b>Problem</b>	<b>Cause / Solution</b>
Surface element is too hot or not hot enough.	Incorrect surface control setting. Adjust power level setting.
Surface element does not heat or does not heat evenly.	Be sure the correct surface control knob is turned on for the element needed. Cookware is light weight or warped. Use only flat, evenly balanced, medium or heavyweight cookware. Flat pans heat better than warped pans. Cookware materials and weight of the material affect heating. Heavy and medium-weight pans heat evenly. Because lightweight pans heat unevenly, foods may burn easily.
Areas of discoloration with metallic sheen on cooktop surface.	Mineral deposits from water and food. Remove them using cooktop cleaning creme applied to the ceramic surface. Buff with a non-abrasive cloth or sponge.
Scratches or abrasions on cooktop surface.	Coarse particles such as salt or hardened soils between cooktop and utensils can cause scratches. Be sure the cooktop surface and bottoms of utensils are clean before use. Small scratches do not affect cooking and will become less visible with time. Cleaning materials not recommended for ceramic-glass cooktop have been used. Apply cooktop cleaning creme to the ceramic surface. Buff with a non-abrasive cloth or sponge. Cookware with a rough bottom was used. Use smooth, flat-bottomed cookware.
Metal marks on the cooktop.	Sliding or scraping of metal utensils on cooktop surface. Do not slide metal utensils on the cooktop surface. Apply cooktop cleaning creme to the ceramic surface. Buff with a non-abrasive cloth or sponge. For more information, see "Cooktop Maintenance" on page 22.
Brown streaks or specks on cooktop surface.	Boil overs are cooked onto the surface. When cooktop is cool, use a razor blade scraper to remove soil. For more information see "Cooktop Maintenance" on page 21.

<b>Self-Clean Problems</b>	
<b>Problem</b>	<b>Cause / Solution</b>
Self clean does not work.	Oven control not set properly. See "Setting Self Clean" on page 28.
Oven racks discolored or do not slide easily.	Oven racks left in oven cavity during self clean. Remove oven racks from oven cavity before starting a self-clean cycle. Clean by using a mild abrasive cleaner following manufacturer's instructions. Rinse with clean water, dry, and replace in oven.
Soil not completely removed after self clean.	Self clean was interrupted. Review instructions on "Self Cleaning" on page 27.  Excessive spills on oven bottom. Remove excessive spills before starting self clean.  Failure to clean soil from the oven frame, the door liner outside the oven door gasket, and the small area at the front center of the oven bottom. These areas are not in the self-cleaning area, but get hot enough to burn on residue. Clean these areas before starting the self-cleaning cycle. Burned-on residue can be cleaned with a stiff nylon brush and water or a nylon scrubber. Be careful not to damage the oven gasket.
The oven control display shows "SPr" and self-clean is not working.	The cooktop should not be used during a self-clean cycle. On some models, turning on any cooktop surface burner will cause the clean cycle to cancel. If the clean cycle is canceled, the oven control display will show "SPr" for 5 seconds. The oven door will remain locked until the oven has cooled down below cleaning temperature. If the oven is below cleaning temperature, the user can start another clean cycle immediately. If the oven is in cleaning temperature range, another self-clean cycle can be set once the door unlocks (up to 4 hours).

<b>Other Problems</b>	
<b>Problem</b>	<b>Cause / Solution</b>
Appliance is not level.	Be sure the floor is level, strong, and stable enough to adequately support the range.  If the floor is sagging or sloping, contact a carpenter to correct the situation.  Poor installation. Place the oven rack in the center of the oven. Place a level on the oven rack. Adjust the leveling legs at the base of the appliance until the rack is level.  Kitchen cabinet alignment may make range appear not level. Be sure cabinets are square and have sufficient room for appliance clearance.
Cannot move appliance easily. Appliance must be accessible for service.	Cabinets not square or are built in too tightly. Contact the builder or installer to make the appliance accessible.  Carpet interferes with appliance. Provide sufficient space so the appliance can be lifted over carpet. Installation over carpet is not advised. See the installation instructions for guidelines specific to your appliance.
Oven light does not work.	Be sure the oven light is secure in the socket. See "Replacing the Oven Light" on page 26.

# 44 WARRANTY

Your appliance is covered by a one year limited warranty. For one year from your original date of purchase, Electrolux will pay all costs for repairing or replacing any parts of this appliance that prove to be defective in materials or workmanship when such appliance is installed, used and maintained in accordance with the provided instructions.

## Exclusions

This warranty does not cover the following:

1. Products with original serial numbers that have been removed, altered or cannot be readily determined.
2. Product that has been transferred from its original owner to another party or removed outside the USA or Canada.
3. Rust on the interior or exterior of the unit.
4. Products purchased "as-is" are not covered by this warranty.
5. Food loss due to any refrigerator or freezer failures.
6. Products used in a commercial setting.
7. Service calls which do not involve malfunction or defects in materials or workmanship, or for appliances not in ordinary household use or used other than in accordance with the provided instructions.
8. Service calls to correct the installation of your appliance or to instruct you how to use your appliance.
9. Expenses for making the appliance accessible for servicing, such as removal of trim, cupboards, shelves, etc., which are not a part of the appliance when it is shipped from the factory.
10. Service calls to repair or replace appliance light bulbs, air filters, water filters, other consumables, or knobs, handles, or other cosmetic parts.
11. Surcharges including, but not limited to, any after hour, weekend, or holiday service calls, tolls, ferry trip charges, or mileage expense for service calls to remote areas, including the state of Alaska.
12. Damages to the finish of appliance or home incurred during installation, including but not limited to floors, cabinets, walls, etc.
13. Damages caused by: services performed by unauthorized service companies; use of parts other than genuine Electrolux parts or parts obtained from persons other than authorized service companies; or external causes such as abuse, misuse, inadequate power supply, accidents, fires, or acts of God.

## DISCLAIMER OF IMPLIED WARRANTIES; LIMITATION OF REMEDIES

CUSTOMER'S SOLE AND EXCLUSIVE REMEDY UNDER THIS LIMITED WARRANTY SHALL BE PRODUCT REPAIR OR REPLACEMENT AS PROVIDED HEREIN. CLAIMS BASED ON IMPLIED WARRANTIES, INCLUDING WARRANTIES OF MERCHANTABILITY OR FITNESS FOR A PARTICULAR PURPOSE, ARE LIMITED TO ONE YEAR OR THE SHORTEST PERIOD ALLOWED BY LAW, BUT NOT LESS THAN ONE YEAR. ELECTROLUX SHALL NOT BE LIABLE FOR CONSEQUENTIAL OR INCIDENTAL DAMAGES SUCH AS PROPERTY DAMAGE AND INCIDENTAL EXPENSES RESULTING FROM ANY BREACH OF THIS WRITTEN LIMITED WARRANTY OR ANY IMPLIED WARRANTY. SOME STATES AND PROVINCES DO NOT ALLOW THE EXCLUSION OR LIMITATION OF INCIDENTAL OR CONSEQUENTIAL DAMAGES, OR LIMITATIONS ON THE DURATION OF IMPLIED WARRANTIES, SO THESE LIMITATIONS OR EXCLUSIONS MAY NOT APPLY TO YOU. THIS WRITTEN WARRANTY GIVES YOU SPECIFIC LEGAL RIGHTS. YOU MAY ALSO HAVE OTHER RIGHTS THAT VARY FROM STATE TO STATE.

## If You Need Service

Keep your receipt, delivery slip, or some other appropriate payment record to establish the warranty period should service be required. If service is performed, it is in your best interest to obtain and keep all receipts. Service under this warranty must be obtained by contacting Electrolux at the addresses or phone numbers below.

This warranty only applies in the USA and Canada. In the USA, your appliance is warranted by Electrolux Major Appliances North America, a division of Electrolux Home Products, Inc. In Canada, your appliance is warranted by Electrolux Canada Corp. Electrolux authorizes no person to change or add to any obligations under this warranty. Obligations for service and parts under this warranty must be performed by Electrolux or an authorized service company. Product features or specifications as described or illustrated are subject to change without notice.

**USA**  
**1-800-374-4432**  
Frigidaire  
10200 David Taylor Drive  
Charlotte, NC 28262

**FRIGIDAIRE**

**Canada**  
**1.800.265.8352**  
Electrolux Canada Corp.  
5855 Terry Fox Way  
Mississauga, Ontario, Canada  
L5V 3E4

# FRIGIDAIRE®

## welcome home

Our home is your home. Visit us if you need help with any of these things:



owner support



accessories



service



registration

(See your registration card for more information.)

Frigidaire.com  
1-800-374-4432

Frigidaire.ca  
1-800-265-8352