

MSA5500

STREAMING INTEGRATED AMPLIFIER

OWNER'S MANUAL



FCC Information (For US Customers)

1. IMPORTANT NOTICE:

DO NOT MODIFY THIS PRODUCT

This product, when installed as indicated in the instructions contained in this manual, meets FCC requirements. Modification not expressly approved by McIntosh may void your authority, granted by the FCC, to use the product.

2. CAUTION:

- To comply with FCC RF exposure compliance requirement, separation distance of at least 20cm must be maintained between this product and all persons.
- This product and its antenna must not be co-located or operating in conjunction with any other antenna or transmitter.

3. COMPLIANCE INFORMATION:

- Product Name: MSA5500 Streaming Integrated Amplifier
- Model Number: MSA5500
- This product contains FCC ID: 2ADBM-LS11

McIntosh Laboratory, Inc.
2 Chambers Street
Binghamton, NY 13903
Tel. (607) 723-3512

IC Information (Canadian Customers)

1. PRODUCT:

This product contains IC: 20276-LS11

This product complies with RSS-210 of Industry Canada. Operation is subject to the following two conditions:

(1) this product may not cause harmful interference, and (2) this product must accept any interference received, including interference that may cause undesired operation. This Class B digital Apparatus complies with Canadian ICES-003.

2. CAUTION:

To reduce potential radio interference to other users, the antenna type and its gain should be so chosen that the equivalent isotropically radiated power (e.i.r.p.) is not more than that permitted for successful communication.

Informations sur IC (pour les clients Canadiens)

1. APPAREIL:

Cet Appareil contient IC: 20276-LS11

Cet Appareil est conforme à la norme CNR-210 du Canada. L'utilisation de ce dispositif est autorisée seulement aux deux conditions suivantes : (1) il ne doit pas produire de brouillage, et (2) l'utilisateur du dispositif doit être prêt à accepter tout brouillage radioélectrique reçu, même si ce brouillage est susceptible de compromettre le fonctionnement du dispositif. Cet Appareil numérique de la classe B est conforme à la norme NMB-003 du Canada.

2. ATTENTION:

Afin de réduire le risque d'interférence aux autres utilisateurs, il faut choisir le type d'antenne et son gain de façon à ce que la puissance isotrope rayonnée équivalente (p.i.r.e.) ne soit pas supérieure au niveau requis pour l'obtention d'une communication satisfaisante.

Canadian Customers: CAN ICES-003 (B)/NMB-003 (B)

RF Exposure Information

This equipment complies with FCC/IC radiation exposure limits set forth for an uncontrolled environment and meets the FCC radio frequency (RF) Exposure Guidelines in Supplement C to OET65 and RSS-102 of the IC radio frequency (RF) Exposure rules. This equipment has very low levels of RF energy that are deemed to comply without testing of specific absorption ratio (SAR).

Cet équipement est conforme aux normes d'exposition aux radiations FCC/IC définies pour un environnement non contrôlé et satisfait les directives d'exposition à la radiofréquence (RF) dans le supplément C des OET65 et RSS-102 des règles d'exposition à la fréquence radio (RF) IC. Cet équipement a de très faibles niveaux d'énergie RF qui sont jugés conformes sans test de taux d'absorption spécifique (SAR).

RED (EN) Information

1. DECLARATION OF CONFORMITY

Our products follow the provisions of EC/EU directives:

LVD: 2014/35/EU

EMC: 2014/30/EU

RED: 2014/53/EU

ERP: EC regulation 1275/2008 and its framework directive 2009/125/EU

RoHS: 2015/863/EU

2. IMPORTANT NOTICE:

DO NOT MODIFY THIS PRODUCT

This product, when installed as indicated in the instructions contained in this manual, meets RED directive requirements. Modification of the product could result in hazardous Radio and EMC radiation.

3. CAUTION:

Separation distance of at least 20cm must be maintained between this product and all persons. This product and its antenna must not be co-located or operating in conjunction with any other antenna or transmitter.

Thank You from All of Us at McIntosh

You have invested in a precision instrument that will provide you with many years of enjoyment. Please take a few moments to familiarize yourself with the features and instructions to get the maximum performance from your equipment. If you need further technical assistance, please contact your dealer who may be more familiar with your particular setup including other brands. You can also contact McIntosh with additional questions or in the unlikely event of needing service.

McIntosh Laboratory, Inc.

2 Chambers Street
Binghamton, New York 13903

Technical Assistance (607) 723-3512
Fax (607) 724-0549

Customer Service (607) 723-3515
Fax (607) 723-1917

Email support@mcintoshlabs.com
Website www.mcintoshlabs.com

Please Take A Moment

For future reference, you can write down your serial number and purchase information here. We can identify your purchase from this information if the occasion should arise:

Serial Number: _____

Purchase Date: _____

Dealer Name: _____

Table of Contents

General Information 4
Trademark and License Information 4
Performance Features.. 5
Connectors and Cable Information 6
Connecting a Loudspeaker.. 7
Dimensions 8
Front Panel Displays and Switches. 9
Rear Panel Connections and Switches10
Using Your MSA550011
Quick Start: Bluetooth.11
Quick Start: Network Connections12
Network Connections13
Other Connections13
Setup Menus14
System Setup Menu..14-15
Digital Setup Menu16-17
Network Setup Menu17
Inputs Setup Menu18
Data Out Setup Menu..18
External Control Setup Menu.19
Browser Interface.20
Passthru Connection Diagram21
Bi-Amplification Connection Diagram..22
Navigating the Remote Control23
How to use the Remote Control24
Trim Functions Menu.. 24-25
General Specifications.26
Amplifier Specifications26
Digital Audio Specifications27
Packing Instructions27

Introduction

Now you can take advantage of traditional McIntosh standards of excellence in the MSA5500 Streaming Integrated Amplifier. The Power Amplifier section of the MSA5500, with a power output of 100 watts per channel, will drive a pair of quality Loudspeakers to a high level of performance.

The flexible Preamplifier section provides connections for various input sources and may also be used to drive an external Power Amplifier(s).

The streaming section includes Apple AirPlay, Google Cast, Spotify Connect, Tidal Connect, Roon Ready ability via wired or wireless internet connection. Bluetooth is included for extra convenience.

The MSA5500 reproduction is sonically transparent and absolutely accurate. The McIntosh Sound is *The Sound of the Music Itself.*

Safety First







Please read the safety instructions included in a separate document called “Important Additional Operation Information Guide.”

General Information

1. Apply AC Power to the MSA5500 and other McIntosh Component(s) after all the system components are connected together. Failure to do so may cause a malfunction of system operations as the microprocessor's circuitry inside the components is active when AC Power is applied.
2. If Power Amplifier Protection Circuitry of the MSA5500 activates, the Front Panel Power Guard LEDs are illuminated continuously and the sound will be muted.
3. If the Power Transformer overheats due to improper ventilation and/or high ambient operating temperature, AC Power is removed from the MSA5500. Normal operation will resume when the operating temperature is in a safe range again.
4. The IR Input, with a 1/8 inch mini phone jack, is configured for non-McIntosh IR sensors. Use a Connection Block when two or more IR sensors need to be connected to the MSA5500. The signal from a connected External IR Sensor will have priority over the signal from the Front Panel IR Sensor.
5. When discarding the unit, comply with local rules or regulations. Batteries should never be thrown away or incinerated but disposed of in accordance with the local regulations concerning battery disposal.
6. The MSA5500 has been tested and certified for indoor use only.
7. For additional information on the MSA5500 and other McIntosh products please visit the McIntosh website at www.mcintoshlabs.com.

Trademark and License Information

The McIntosh MSA5500 incorporates copyright protected technology that is protected by U.S. patents and other intellectual property rights. The MSA5500 uses the following technologies:







Trademark Logo	License Information
	ASIO is a trademark and software of Steinberg Media Technologies GmbH.
	The terms HDMI, HDMI High-Definition Multimedia Interface, and the HDMI Logo are trademarks or registered trademarks of HDMI Licensing Administrator, Inc.
	For DTS patents, see http://patents.dts.com . Manufactured under license from DTS Licensing Limited. DTS, DTS:X, and the DTS:X logo are registered trademarks or trademarks of DTS, Inc in the United States and other countries. © 2020 DTS, Inc. ALL RIGHTS RESERVED.
	Dolby, Dolby Audio, and the double-D symbol are registered trademarks of Dolby Laboratories Licensing Corporation. Manufactured under License from Dolby Laboratories. Confidential unpublished works. Copyright © 2012-2024 Dolby Laboratories. All rights reserved.
	Use of the Works with Apple badge means that an accessory has been designed to work specifically with the technology identified in the badge and has been certified by the developer to meet Apple performance standards. Apple, and AirPlay are trademarks of Apple Inc., registered in the U.S. and other countries and regions. To use AirPlay with the MSA5500 Streaming Audio Amplifier, the latest version of iOS, iPadOS, or macOS is recommended.
	Google Cast is a trademark of Google LLC.

Trademarks of McIntosh Laboratory, Inc.

The following are Registered Trademarks of McIntosh Laboratory, Inc. in multiple jurisdictions around the world: the written McIntosh logo; the McIntosh Globe logo; the Mc logo; Power Guard; Power Guard Screen Grid Sensor; Power Guard SGS; LD/HP; Dynamic Power Manager; the 4DPM8 logo; HXD; the HXD logo; Behind The Sound; Legendary Performance.

The following are Trademarks of McIntosh Laboratory, Inc. in multiple jurisdictions around the world: Autoformer; Sentry Monitor; Solid Cinch; McIntosh Monogrammed Heatsinks; Hybrid Drive; DualView; TripleView; Made of Sound.

The foregoing trademarks, registered and otherwise, are not to be used, reproduced, or registered in any way without the express written permission of McIntosh Laboratory, Inc.

Trademark Logo	License Information
	The Bluetooth® word mark and logos are registered trademarks owned by Bluetooth SIG Inc. and any use of such marks by McIntosh is under license. Other trademarks and trade names are those of their respective owners.
 	Qualcomm® aptX™ is a product of Qualcomm Technologies, Inc. and/or its subsidiaries. Qualcomm is a trademark of Qualcomm Incorporated, registered in the United States and other countries. aptX is a trademark of Qualcomm Technologies International, Ltd., registered in the United States and other countries.
	The Wi-Fi CERTIFIED logo is a registered trademark of the Wi-Fi Alliance. Wi-Fi Certification provides assurance that the device has passed the interoperability test conducted by the Wi-Fi Alliance, a group that certifies interoperability among wireless LAN devices.
	Roon Ready network devices have Roon's streaming technology built in, and are certified by Roon Labs to provide the highest level of quality and performance in network streaming.
	TIDAL is the first global music streaming service with high fidelity sound, hi-def video quality, along with expertly curated playlists and original content - making it a trusted source for music and culture.
	The Spotify Software is subject to third party licenses found here: https://developer.spotify.com/third-party-licenses .

- **Built-in casting technologies**

Streaming services such as Spotify® Connect, TIDAL® Connect, Apple® AirPlay®, Bluetooth®, Google Cast, and Roon Ready, let you easily stream to the MSA5500 from your smart devices.

- **Digital Audio Inputs**

The MSA5500 has coaxial, optical, MCT DIN, HDMI (ARC), and USB inputs to decode PCM and DSD signals from an external source. The coaxial and optical inputs process digital signals up to 192kHz with 24-bit resolution and decode Dolby Digital and DTS bitstreams. The digital MCT DIN connection allows for streaming of high bandwidth digital signals (DSD, PCM) from external sources. The USB input processes PCM digital signals up to 192kHz with 32-bit resolution, decodes up to DSD512 digital signals and DXD 24-bit with a sampling rate of 352.8kHz (or 384kHz).

- **Moving Magnet Phono Inputs**

The MSA5500 Moving Magnet Input Circuitry uses the latest design to provide the lowest possible noise, distortion and flat frequency response..

- **Quad Balanced Digital-to-Analog Converter**

The 8 channel 32-bit digital-to-analog converter is used in a stereo quad balanced mode, assuring the music is reproduced with a wide dynamic range and extremely low distortion.

- **Gold Plated Connectors**

The input and output connector contacts are gold plated for superior corrosion resistance and high electrical conductivity.

- **HDMI TV Sound**

The HDMI ARC (Audio Return Channel) allows you to use your entire audio system to play the sound from your TV, including the over-the-air broadcasts, HDMI inputs, and streaming services.

- **Power Output**

The MSA5500 consists of 100 watts (8 ohm) or 160 watts (4 ohm) per channel Stereo Power Amplifier with less than 0.005% distortion. The McIntosh MSA5500 is designed for connection of a single 8 ohm or 4 ohm Loudspeaker per channel. The Power Amplifier uses ThermalTrak1 Output Transistors for lower distortion and cool operation.

- **Power Guard**

The patented McIntosh Power Guard circuit prevents amplifier clipping and protects your valuable Loudspeakers.

- **Sentry Monitor and Thermal Protection**

McIntosh Sentry Monitor power output stage protection circuits ensure the MSA5500 will have a long and trouble free operating life. Built-in Thermal Protection Circuits guard against overheating.

- **Front Panel**

The famous McIntosh Illuminated Glass Front Panel uses LEDs to ensure the pristine beauty of the MSA5500 will be retained for many years. The Front Panel Display indicates source selection, volume levels, and setup functions. The Illuminated Power Output Meters are peak responding, and indicate the power output of the amplifier.

- **PassThru Mode**

The Automatic PassThru Mode allows the MSA5500 to become part of a Multichannel Sound System for DVD-Audio, SACD and Home Theater Movies.

- **Power Control Output**

A Power Control connection for convenient Turn-On of McIntosh Power Amplifiers, Source Components and Accessories is included.

- **Remote Control**

The Data Ports together with the supplied Remote Control provide control of McIntosh Source Components connected to the MSA5500.

- **McIntosh Custom Binding Posts**

McIntosh Patented gold plated output terminals deliver high current output. They accept large diameter wire and spade lugs. Banana plugs may also be used only in the United States and Canada.

- **Qualcomm® aptX™ Audio**

aptX™ is a codec that can provide CD quality music over Bluetooth connections. The MSA5500 will automatically utilize aptX when connected to a source that supports aptX.

The MSA5500 also supports the higher resolution aptX HD (24-bit/48kHz). If your device utilizes aptX HD then that resolution will be utilized automatically.

The MSA5500 also features aptX Adaptive. This technology works with supporting mobile devices to automatically select the best audio/latency performance for maximum listening enjoyment.

Connectors and Cable Information

XLR Connectors

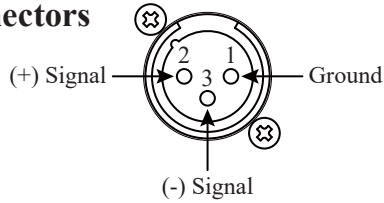

RCA Connectors

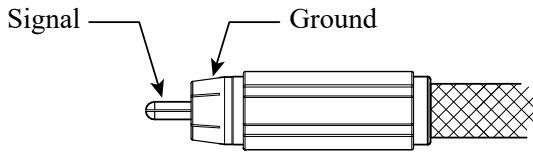

Power Control Connectors

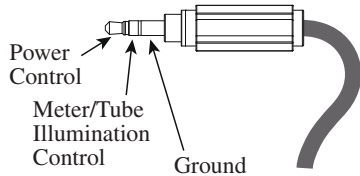

Output Terminals

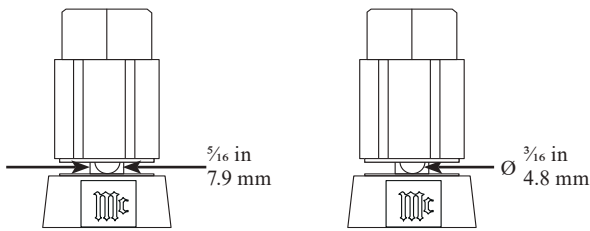

Data Ports and External Control Connectors

Data Ports send converted IR commands to other McIntosh components. A 3.5mm stereo mini phone plug is used for connections.

The IR IN port also uses a 3.5mm stereo mini phone plug and allows the connection of other brand IR receivers to the MSA5500. The IR receiver must provide its own power supply.

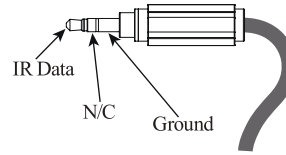

The RS232-C Data Cable is a 3.5mm stereo mini phone plug used to connect to external third party controllers.

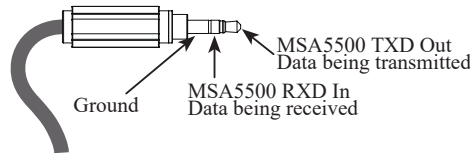

NET Port (Ethernet / 10baseT LAN)

Use an Ethernet cable to connect the MSA5500 to a network router. The network connector is located on the rear panel of the MSA5500 to the left of the CAUTION label. It is labeled NET.

By default, the MSA5500 has DHCP set to ON and will automatically receive an IP address from the router. This setting can be changed.

Alternatively, the MSA5500 may be connected to your home network via wireless Wi-Fi. In this case then the Ethernet connection would not apply.

McIntosh Plug-In Jumper Connector

The MSA5500 utilizes two phono style Plug-In Jumpers to connect the Preamplifier Output to the Power Amplifier Input.

Note: Additional or replacement Jumper Connectors can be obtained from the McIntosh Parts Department under Part No. 117781.

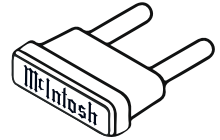

USB Type B Input

The USB audio input of the MSA5500 provides the capability to receive music/sound in a digital format from a connected computer. Apple® computers with OS-10.6.8 or later will communicate with the MSA5500 automatically when connected.

For Windows-based computers (PC), Windows 7 (Service Pack 1) or later is required. The correct McIntosh USB audio driver must be installed. To install the McIntosh USB driver for Windows-based computers download the latest driver from the McIntosh website: www.mcintoshlabs.com

The driver can be found in the Downloads section of the webpage under Software Updates. Choose the McIntosh USB Audio Windows Driver. You may select this driver in many third-party applications such as JRiver Media Center.

The MSA5500's display will show the sampling rate or bit rate for the USB input.

Optical

The two optical inputs allow digital sources to be connected to the MSA5500 using TOSLINK cables also known as "optical audio cables." The optical inputs can handle high resolution digital audio up to 192kHz/24-bit. The MSA5500 DAC will process standard format SPDIF PCM signals and Dolby Digital and DTS bitstreams. Unsupported formats can result in strange and/or unpleasant sounds.

Connecting a Loudspeaker

Coax

The two digital coaxial inputs allow digital sources to be connected to the MSA5500 using Digital Audio RCA coaxial Cables. The coax inputs can handle high-resolution digital audio up to 192kHz/24-bit. The MSA5500 DAC will process standard format SPDIF PCM signals and Dolby Digital and DTS bitstreams. Remember, unsupported formats can result in strange and/or unpleasant sounds.

The McIntosh MSA5500 Power Amplifier Circuitry is designed for a Loudspeakers with minimum 4 ohms impedance. Connect a single Loudspeaker only to the Right and Left Output Terminals.

Do not connect the AC Power Cord to the MSA5500 Rear Panel until after the Loudspeaker Connections are made. Failure to observe this could result in Electric Shock.

Loudspeaker Cables

When connecting loudspeakers to the MSA5500 it is very important to use cables of adequate size. The size is specified in AWG (American Wire Gauge). The smaller the gauge number, the larger the wire size.

Loudspeaker Cable Wire Gauge Guide			
Loudspeaker Impedance	Cable Distance		
	25 feet (7.62 meters) or less	50 feet (15.24 meters) or less	100 feet (30.48 meters) or less
4 ohms	14AWG	12AWG	10AWG
8 ohms	16AWG	14AWG	12AWG

Loudspeaker Cable Connections

When connecting loudspeaker cables to the MSA5500 output terminals follow the steps:

1. **Make sure AC power is disconnected.**
2. Rotate the top of the output terminal counterclockwise until an opening appears.
3. Insert the loudspeaker cable into the output terminal. **Proper polarity must be maintained for all connections. (+/-)**
4. Rotate the top of the output terminal clockwise until it is finger tight.
5. Place the McIntosh wrench over the top of the output terminal and rotate the output terminal clockwise one quarter of a turn (90°).

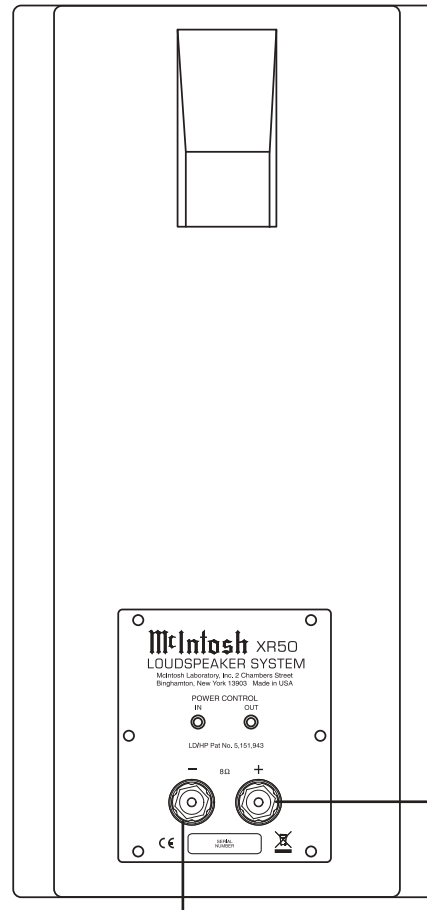
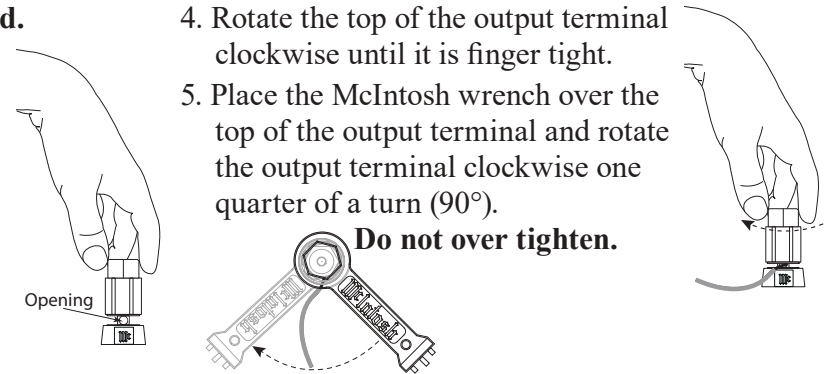

MSA5500 Rear

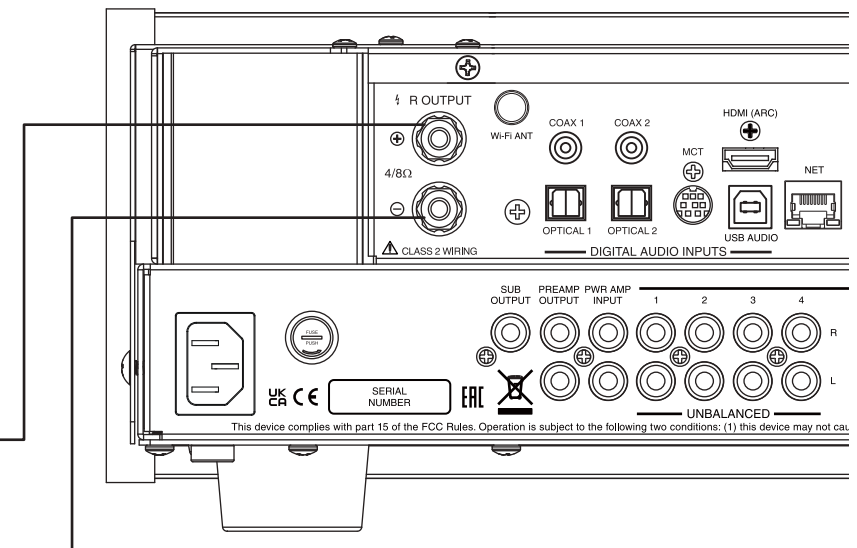

Dimensions

The following dimensions can assist in determining the best location for your MSA5500.

A Note on Placement:

It is important to keep your McIntosh unit out of direct sunlight and only use appropriate gentle cleaners because the organic anodize can become discolored over time. While most products will maintain their classic dark features for their lifetime, some situations can accelerate discoloration. The most pervasive culprit is UV light, especially light directly from the sun, or high intensity spotlights. Even high intensity short-term exposure can result in discoloration. Chemicals can also alter the finish of the anodize. Aggressive cleaners will take their toll over time and actually etch away the anodize finish.

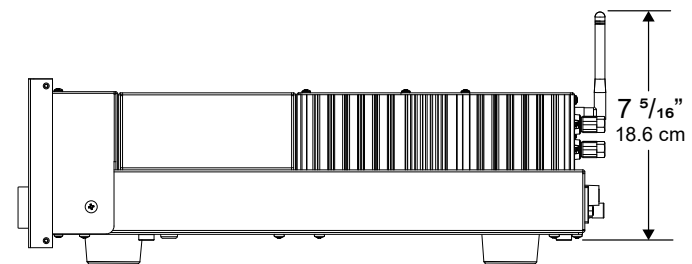
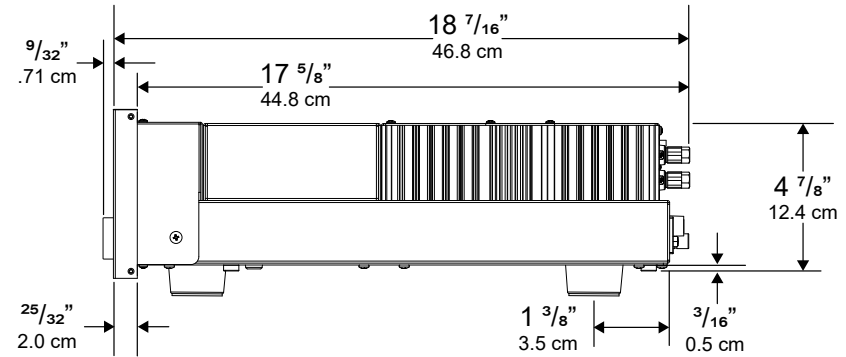
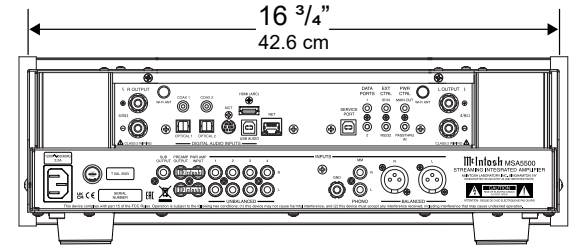
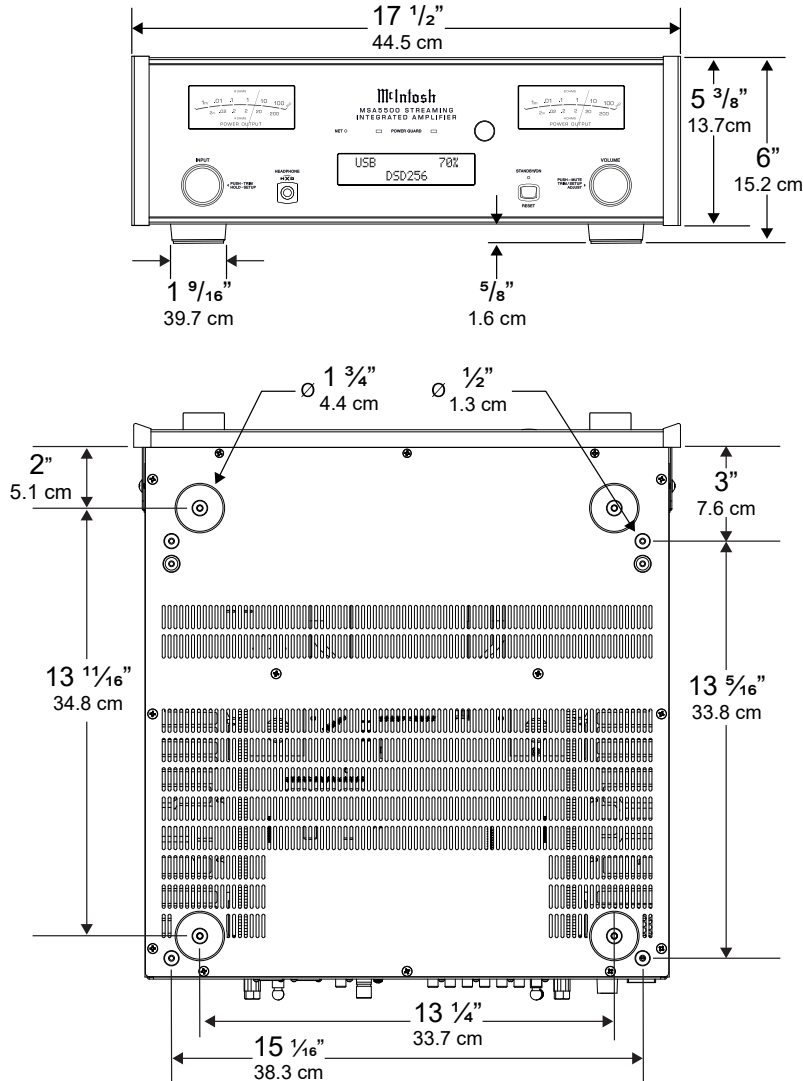

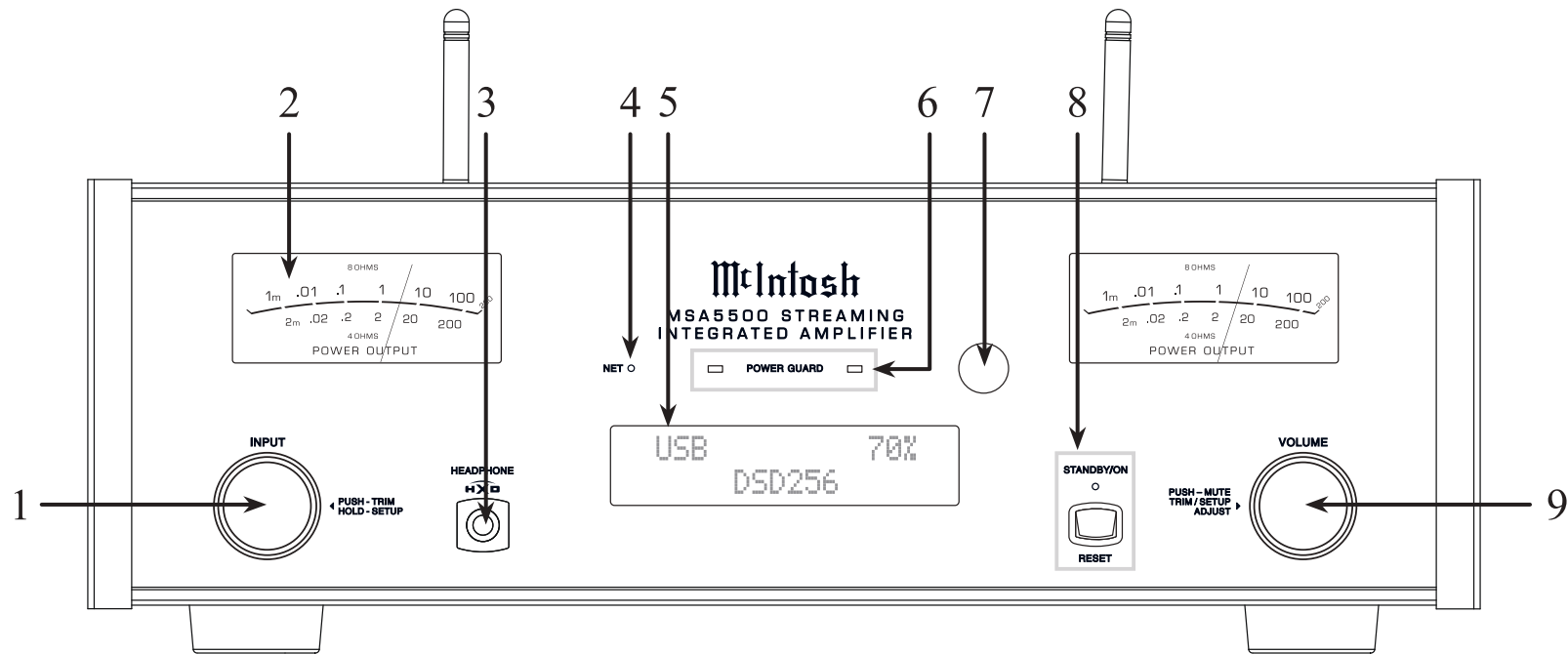

Front Panel Displays and Switches

- INPUT Knob** rotates to select different input sources for playback and navigate through different options in the menus. Access Trim or Setup menus by holding or pressing the knob in.
- METERS** indicate POWER OUTPUT to the left and right loudspeakers.
- HEADPHONE** connection for low impedance dynamic headphones, for private listening.
- NETWORK LED** will light up in the following ways:
- VFD (Vacuum Florescent Display)** indicates the Input, Source information, and Volume Level. Alternatively, can display Trim and Setup options. The VFD's intensity is also adjustable.
- POWER GUARD LEDs** will illuminate under the following conditions:
 - When the Power Guard circuit activates to control excessive distortion in the audio output.
 - When the audio is muted due to high temperatures in either of the heatsinks.
 - When the audio is muted during the MSA5500 power on sequence (approximately 10 seconds).
- IR Sensor** receives commands from your remote control.
- STANDBY/ON Indicator LED** illuminates when the MSA5500 is connected to AC power. **STANDBY/ON Button** turns the MSA5500 On and Off.
- VOLUME Knob** adjusts the output level. Also used to navigate in the menus and trims. Pressing the knob will mute the volume.

LED	Status
None	No network connection
Green slow pulse	Connecting to a network
Green solid	Network connected
Red solid	A network error has occurred
Amber solid	Firmware requires an update

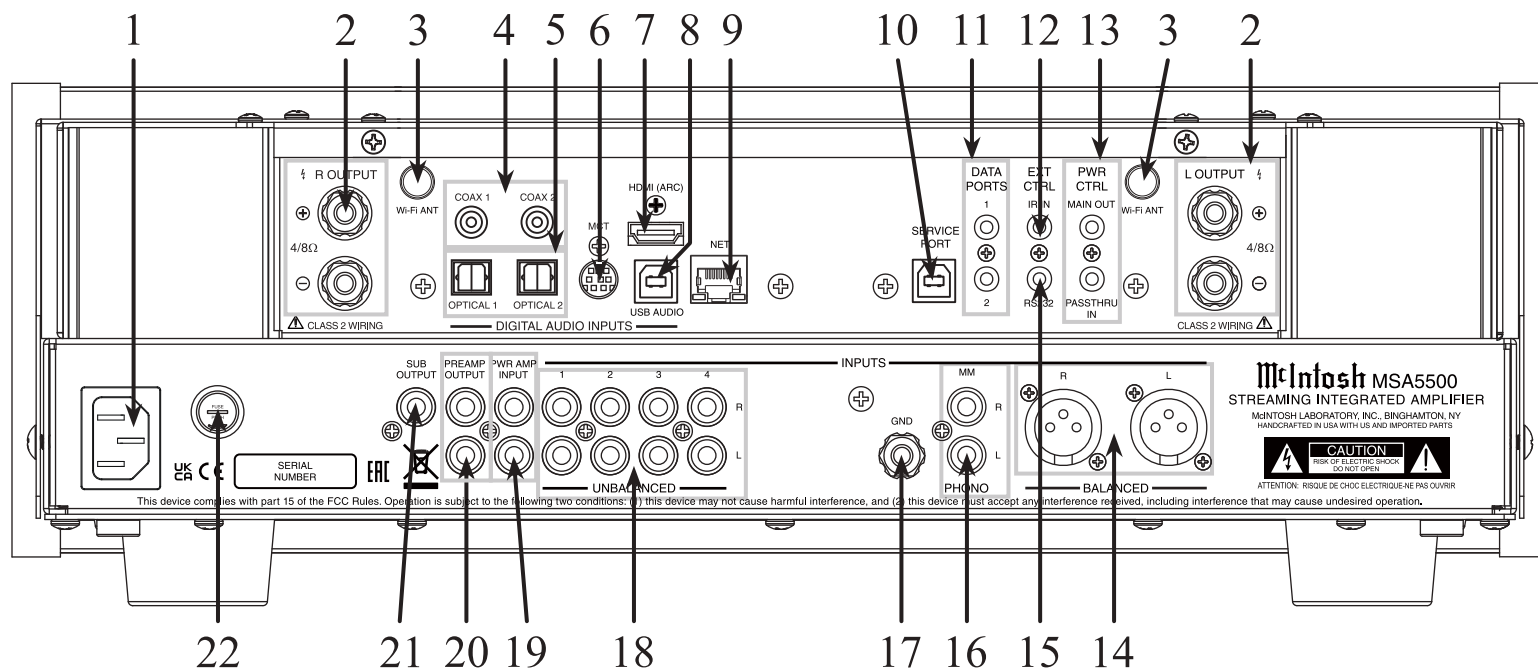

Rear Panel Connections and Switches

1. **AC Input** connects to an AC Outlet for power.
2. **Loudspeaker Terminals** connect to a loudspeaker for audio output.
3. **Wi-Fi ANTenna** connection for wireless Wi-Fi.
4. **COAX Inputs (1 and 2)** accept coaxial cables for digital signals.
5. **OPTICAL Inputs (1 and 2)** accept optical connections for digital signals.
6. **MCT Input** transfers signals from McIntosh products with an MCT connector and is required for SACD audio.
7. **HDMI (ARC) Input** connects with a compatible ARC TV using an HDMI cord.
8. **USB AUDIO Input** is a USB Type-B connector used to connect the MSA5500 to a computer to stream digital audio.
9. **EtherNET Input** for a wired network connection.
10. **SERVICE PORT** is used for service purposes only.
11. **DATA PORTS** receive operating data from a McIntosh preamplifier or Control Center.
12. **IR INPUT** connects to an IR receiver using a 3.5mm stereo mini phone plug cable.
13. **PASSTHRU IN** receives turn On/Off signals from another McIntosh component. **Power Control MAIN OUT** sends a turn On/Off signals to another McIntosh component.
14. **BALANCED Input**
15. **RS232** communicates with external control devices using a 3.5mm stereo mini phone plug cable.
16. **Phono Input for MM cartridge**
17. **Ground connection** to use with a turntable to prevent noise.
18. **UNBALANCED Inputs**
19. **Power Amp Input** connects the MSA5500's Preamp Output to the onboard power amplifiers using the included Jumper Plugs, see page 6.
20. **PREAMP OUTPUT** sends adjustable audio via RCA cables. Connect included Jumper Plugs, see page 6, to PWR AMP Input to drive the onboard power amplifier.
21. **SUBwoofer Unbalanced OUTPUT** send signals to Power Amplifier(s) and is active along with PREAMP OUTPUT.
22. **Fuse holder**, refer to back panel of the MSA5500 for correct fuse size and rating.

Note: The HDMI ARC functionality of the MSA5500 is only compatible with ARC TVs. Other devices like DVD and Blu-ray players will not work.

Using Your MSA5500

Powering On / Turning Off:

While the unit is in Standby Mode (no lights except the LED indicator light are on), press the STANDBY/ON Button to power on the unit.

While the unit is on, press the STANDBY/ON Button again to enter Standby Mode (turn it off). Using the remote control, press the power button to turn the MSA5500 On or Off where appropriate. If power control is connected from a preamplifier, the MSA5500 will automatically turn on and off with the preamplifier.

The MSA5500 has the ability to automatically switch power On or Off to source components via the power control connections. The data port connections allow for the remote operation of basic functions using the remote control. With an external sensor connected to the MSA5500, remote control operation of the system is possible from another room and/or when the MSA5500 is located in a cabinet with the doors closed.

Selecting an Input for Playback:

You can change the current playback source by rotating the INPUT knob or by using the input button on the remote control.

Adjusting the Level:

Rotate the ADJUST knob or use the volume buttons on the remote control to adjust the volume. The current volume level is represented by a percentage on the display.

MCT Input

When playing a multi-layer SACD, select the stereo (SACD) or CD layer. The multi-channel layer will not reproduce sound.

Troubleshooting

In the unlikely event that your commands are not being registered by the unit, you can reset the microprocessors. To do so, hold the STANDBY/ON button down until the LED indicator light switches off. Release the button, and when the light illuminates again, you can press the button again to power the unit On and resume normal operation.

Quick Start: Bluetooth

The following steps are the fastest way to connect to the MSA5500 and start listening to music:

1. Connect to the MSA5500 to AC Power.
2. Power the MSA5500 On by pressing and releasing the STANDBY/ON button.
3. Rotate Input knob to show Bluetooth. Press the Input control to enter the Trim Menu. Rotate the left knob until Bluetooth Pairing is shown. Rotate the right control to enter the Pairing Mode. This action is automatic for first time powering On or immediately following a factory reset.
4. On the phone (or other device) you wish to connect, press SCAN in the Bluetooth section of Settings.
5. The MSA5500 will appear as “MSA5500-ALXxxxx” in Available Devices.
6. Choose the MSA5500 to pair.
7. When asked to confirm you want to pair the MSA5500 to your device, select OK.
8. The MSA5500 should now be “Connected for audio”.
9. Play some music.

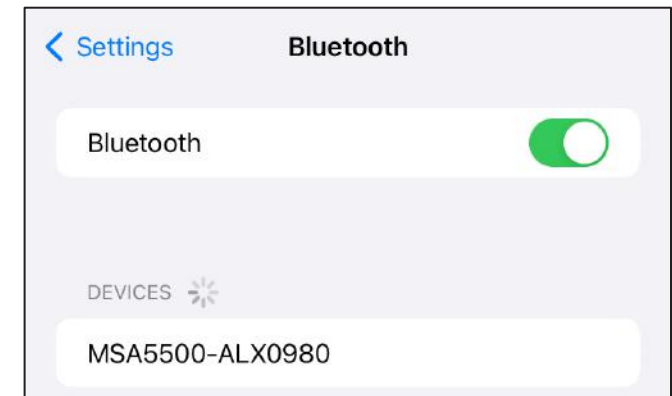

Quick Start: Network Connections

When your MSA5500 connects to your network for the first time, it will automatically look for the latest software update. If available, the MSA5500 will install the newest version. When updating, the VFD will show the following messages:

```
UPDATE DETECTED
Downloadine
```

```
UPDATING: DSI
Installine...
```

```
UPDATING: MSA5500
MESSAGES
```

Updating **MESSAGES** will indicate downloading and updating the internal processors, as necessary in the included update. The unit will reboot when the operation has completed. Do not remove power during this operation.

Ethernet

For a wired connection to your network, use an Ethernet cable to connect the MSA5500 to your router.

Note: A solid red Network/Wi-Fi LED indicates that a network error has occurred. See page 9.

Note that plugging in an Ethernet cable will disable the Wi-Fi radio of the MSA5500. The MSA5500 will use the Ethernet connection for all network activity. To enable Wi-Fi, the Ethernet cable must be removed.

With an Ethernet connection, you can use the MSA5500 browser interface to provide the MSA5500 with your Wi-Fi settings. For more information, see “The Browser Interface” on page 20.

Setting up Wi-Fi Using Ethernet

To connect your MSA5500 to a Wi-Fi network using an Ethernet connection follow these steps:

1. Power the MSA5500 Off and then On
2. Connect the MSA5500 using an Ethernet cable. The unit should immediately connect.
3. Open a web browser.
4. Check the MSA5500 for current connection IP address and type into browser.
5. Select Settings from the MSA5500 interface
6. Select Wireless in Network Type
7. Select Start Scan
8. Select your network
9. Provide your password and press Connect
10. Your MSA5500 will connect to your network

Wi-Fi Connection using an iOS Device

To set up the MSA5500 as an AirPlay device, a device with iOS 11.4 or later is required. Airplay will connect the MSA5500 to your Wi-Fi network automatically. Follow the steps below for set up:

1. Make sure your iOS device is on the Wi-Fi network you wish to connect the MSA5500 to and the MSA5500 is powered on.
2. Open up Settings on the iOS device.
3. Open up the Wi-Fi submenu.
4. Look at the Wi-Fi network list and find “Set Up New AirPlay Speaker”
5. Select the MSA5500
6. The MSA5500 will be added to your network
7. Alternatively, use the iOS Home app to join the MSA5500 to your network

Wi-Fi Connection using an Android Device

1. Connect your mobile device/tablet to the same Wi-Fi network as your MSA5500 and power on the MSA5500.
2. Download the McIntosh Cast Connect App from the app store on your device.
3. Open the app and follow the steps for the MSA5500 as they automatically appear.

Network Connections

Google Cast

To Cast to your MSA5500 follow the steps below:

1. Connect your mobile device/tablet to the same Wi-Fi network as your MSA5500 and power on the MSA5500.
2. Download the McIntosh Cast Connect App from the app store on your device.
3. Open the app and follow the steps for the MSA5500 as they automatically appear.
4. Accept Google's terms of service to enable Google Cast streaming.
5. Once the MSA5500 is setup, you can choose to Cast to it. By clicking the Cast button in the top right corner of any Google Cast-enabled app and selecting the MSA5500.
6. When connected the Cast button will change colors.

Roon

The MSA5500 is Roon Ready so when connected to your network, the MSA5500 will be available as a Zone for your Roon server (if you have a Roon server). The MSA5500 can be connected to your Wi-Fi using any of the methods on the previous page. It can also be directly connected with an Ethernet cable.

Spotify Connect

Spotify Connect allows you to use your phone, tablet or computer as a remote control. Connect the MSA5500 to your network using one of the methods on the previous page and then while playing music on Spotify, select your MSA5500 as your device to listen on in the bottom left corner.

Use your phone, tablet, or computer as a remote control for Spotify. Go to <https://www.spotify.com/connect> to learn how.

Tidal Connect

To listen to music on TIDAL through the MSA5500, using the Tidal app, select the content you want to play and then select the connect icon  on the Now Playing screen.

This will bring up a list of nearby devices to stream through. Locate the MSA5500 and select to pair.

If you are unable to find your device, make sure the device is connected to the same Wi-Fi network you are streaming from.

Once paired you can use your TIDAL app as a remote. TIDAL is compatible with select smart assistants that enable voice controls. Depending on your region, you may enable this feature by linking your TIDAL account with your selected smart device. This option can normally be found in the Settings section of your respective Smart Devices app.

Airplay

Airplay is an Apple technology designed to control home audio systems and speakers in any room with a tap or by asking Siri.

To control this Airplay enabled device, follow the “Wi-Fi Connection using an iOS Device” instructions on the previous page.

Other Connections

HDMI ARC

The HDMI ARC (Audio Return Channel) allows you to use your entire audio system to play the sound from your TV.

Notes about Setup:

- Ensure you are connected to the TV's HDMI input port that is labeled “ARC”.
- Your TV's setup menu and settings may need to be adjusted before sound is heard.
- When the MSA5500 is set to the HDMI input, the unit will automatically turn On and Off with the TV. The front display will show “Entering HDMI Standby Mode” when turning Off.
- Multi-channel formats will be down mixed to a 2-channel output.

Audio formats supported by HDMI ARC:

- PCM (2 channel)
- Dolby Digital (up to 5.1 channel)
- DTS Digital Surround (up to 5.1 channel)

Setup Menus

The Setup Menus are listed below.

- System
- Digital
- Network
- Inputs
- Data Out
- External Control

How to Navigate the Setup Menus

Your McIntosh MSA5500 has been factory configured for default operating settings that will allow immediate enjoyment of superb audio without the need for further adjustments. If you wish to make changes to the factory default settings, a Setup Menu is provided to customize the operating settings using the Front Panel Information Display.

Note: If the MSA5500 is currently On, proceed to step 2.

1. Press and hold in the INPUT Knob until the Front Panel Information Display indicates

```
  SETUP: Menu Select
<      System      >
```

2. Rotate the INPUT Knob to select any of the available submenus.
3. To enter the selected submenu, press and hold the INPUT Knob.
4. Rotate the INPUT knob to navigate available options in the selected submenu.
5. Rotate the VOLUME knob to change the selected option's value.
6. To exit from the Setup Menu, or any of the submenus, press the INPUT Knob.

System Setup Menu

Settings	Options
Product	MSA5500 XXX_ _ _ _ _
Firmware	_ . _ . _
Passthru	Off
Auto Off	Disabled, Enabled
Power Save	Disabled, Enabled
Restore Defaults	Default Settings
Factory Reset	Default Settings

Product Information

Specific identifying information for the MSA5500, including the System Firmware Version, can be found on the Product Information page of the System Setup Menu. This firmware effects the main circuitry and can be identified by opening the System Setup Menu.

Firmware

The MSA5500 will periodically check for updates. The current firmware version will be displayed here.

Passthru

When the MSA5500 is part of a Home Theater or Multichannel Audio System, the Right and Left Front Channels from an Audio/Video Processor or Surround Decoder can “Passthru” the MSA5500 and onto its associated Power Amplifier(s). The Passthru setting allows selection of the specified MSA5500 Input to be used for the Right and Left Front Channels. In the example below, the Right and Left Front Channels from the Audio/Video Processor will be connected to the UNBALANCED 2 Input Connectors on the MSA5500. Refer to page 6 for additional connection information.

Note: The Phono and Digital Inputs are not assignable as a Passthru Input.

1. Use the INPUT Knob to enter the System Setup Menu.
2. Rotate the INPUT Knob until the following appears on the Information Display.

```
System: < Passthru >
        Off >
```

3. Rotate the VOLUME Knob to select “UNBAL 2” Input.

```
System: < Passthru >
        < UNBAL 2 >
```

4. Exit the System Setup Menu by pressing the INPUT Knob.

System Setup Menu (continued)

Auto Off

Enabled: The MSA5500 will automatically enter Standby/Off Mode after approximately 30 minutes without user activity (includes changes to any of the Operation Functions such as source selection, volume adjustment, etc.) and absence of an audio signal.

Disabled: The MSA5500 must be turned off by pressing the STANDBY/ON Button.

Power Save

Enabled: The Network, Wi-Fi, and digital inputs including HDMI, section will not be powered when the unit is in Standby mode, preventing remote activation. The IR Remote, RS232, plus Power Control remain active.

Disabled: The MSA5500 will maintain network connections. This will allow the unit to be remotely activated and turned On by your mobile device or network connected device, like a PC or connected TV.

Restore Defaults

To reset all the adjustable settings (Setup and Trim Settings) to the factory default values, perform the following steps:

1. Select the Defaults option in the System Setup Menu. The following should be on the Information Display.



```
System: < Defaults >
Hold INPUT to Reset
```

3. Press and hold in the INPUT Knob until the following appears on the Information Display, then release the INPUT Knob.



```
System: < Defaults >
In Progress!
```



```
System: < Defaults >
Completed!
```

4. Press the front panel STANDBY/ON Button to switch the MSA5500 on.

Factory Reset

To reset all adjustable settings and clear all network information, select Factory Reset and follow the same process as above.

Digital Setup Menu

Settings	Options
DS Module	v#.#
Update	(Hold INPUT)
OPT 1	0dB to +15dB in 1dB intervals
OPT 2	0dB to +15dB in 1dB intervals
HDMI(ARC)	0dB to +15dB in 1dB intervals
Lip Sync	Manual, Automatic
CEC Power	Disabled, Enabled
CEC Volume	Disabled, Enabled

DS Module Firmware Version

The MSA5500 functionality is controlled by internal software that is known as Firmware. The Firmware Number for the Digital Streaming Circuitry of the MSA5500, and can be viewed by following the steps below:

1. Press and hold the INPUT Knob to enter the Setup Menu.
2. Rotate the INPUT Knob until the Front Panel Information Display indicates

```
SETUP: Menu Select
< Digital >
```

3. Press and hold the INPUT Knob to open the Digital Setup Menu and the Information Display will show the DS Firmware version.

DS Update

This option is for service purposes only.

Digital Gain

The MSA5500 offers Digital Gain Adjustments for the HDMI, OPTICAL 1 (OPT 1) and OPTICAL 2 (OPT 2) Inputs. The change in gain

of a specific Digital Input, will produce a change in playback volume of the music. To change the gain for the HDMI Input perform the following steps:

1. Use the INPUT Knob to enter the Digital Setup Menu.
2. Rotate the INPUT Knob until the following appears on the Information Display.

```
Digital: < HDMI (ARC) >
+15dB
```

3. The gain can be adjusted in 1dB Gain steps by rotating the VOLUME Knob counterclockwise to reduce the gain downwards from +15 dB all the way to 0dB.
4. To adjust other Gain values, rotate the INPUT Knob to select OPT 1 or OPT 2 and the gain is adjustable in 1dB Gain steps. 0 dB is the default setting for Optical 1 and Optical 2.

```
Digital: < OPT 1 >
0 dB
```

5. The gain can be increased by rotating VOLUME Knob clockwise to increase the gain from 0 dB with an increase all the way up to +15 dB or +8dB from 0 dB.

```
Digital: < OPT 1 >
+ 15 dB
```

```
Digital: < OPT 2 >
+ 8 dB
```

HDMI (ARC) CEC Power

The MSA5500 HDMI Input Connector has (ARC) Audio Return Channel Circuitry, allowing the Audio Selection and Control Command of HDMI TV/Monitor Devices. By default the HDMI Input is configured to accept Power commands via CEC.

To prevent the CEC Power Control of the MSA5500, simply change HDMI CEC Power from On to Off.

```
Digital: < CEC Power >
< Enabled
```

```
Digital: CEC Power
Disabled >
```

HDMI (ARC) CEC Volume

To change the Consumer Electronics Control (CEC) of the volume, perform the following steps:

1. Use the INPUT Knob to enter the Digital Setup Menu.
2. Rotate the INPUT Knob until the following appears on the Information Display.

```
Digital: < CEC Volume >
< Enabled
```

3. To deactivate the Consumer Electronics Control (CEC), rotate the VOLUME Knob until the following appears on the Information Display.

```
Digital: < CEC Volume >
Disabled >
```

Digital Setup Menu (continued)

HDMI (ARC) Lip Sync Mode

The MSA5500 HDMI Input Connector (ARC), also has another control function. When listening and viewing a TV/Monitor HDMI Input Signal, the ARC circuitry provides a synchronized Video and Audio TV/Monitor Signal. To switch Off the AUTO Synchronised Video and Audio TV/Monitor Signal, perform the following steps:

1. Use the INPUT Knob to enter the Digital Setup Menu.
2. Rotate the INPUT Knob until the following appears on the Information Display.

```
Digital: < Lip Sync >
         < Auto
```

3. To manually configure the lip sync delay, rotate the VOLUME Knob until the following appears on the Information Display.

```
Digital: < Lip Sync >
         Manual >
```

4. The delay time can then be adjusted from the Trim Menu when the HDMI (ARC) Input is selected.

Network Setup Menu

The Network Information Menu lists information about network connection. The chart below details all of the available settings.

Settings	Options
Connection Type	Displays Connection Type
IP Address	Displays IP Address
MAC Address	Displays MAC Address

Inputs Setup Menu

Setting	Options
BALANCED	On/Name, Off
UNBAL 1-4	On/Name, Off
MM PHONO	On/Name, Off
COAX 1, 2	On/Name, Off
OPT 1, 2	On/Name, Off
USB	On/Name, Off
MCT	On/Name, Off
HDMI(ARC)	On/Name, Off
Network	On/Name, Off
Bluetooth	On/Name, Off

Hold the INPUT Knob to open the Inputs Setup Menu and from there, the following changes can be made:

```
SETUP: Menu Select  
< Inputs >
```

On/Name: The selected input will be functioning as normal. Hold in the INPUT Knob to enter the menu to rename the input*.

Off: The selected input will be deactivated and will no longer be selectable from the main display during normal use. Change this setting back to “On /Name” to make it selectable again.

***Naming Inputs:** While in the selected input’s submenu, use the INPUT Knob to navigate to the input with the name you’d like to change (and turn it On using the VOLUME Knob if it isn’t already) so that the display says “Inputs: [input name] On/Name” and hold the INPUT Knob to begin renaming. The character you are currently adjusting will be blinking. Rotate the INPUT Knob to select which character you want to change and use the VOLUME Knob to change the character.

Data Out Setup Menu

Data Port Connections between the MSA5500 and a McIntosh Source Component allow for basic function control of the source component using the MSA5500 supplied HR085 Remote Control. By default, all of the four Data Ports are set to send the same Data to the selected source. To dedicate a given Data Port for only one source component (example, source component connected to the UNBAL 1 Input will be assigned to Data Port 1) perform the following Steps:

1. Use the INPUT Knob to enter the Data Out Setup Menu.
2. Rotate the INPUT Knob until the following appears on the Information Display.

```
SETUP: Menu Select  
< Data Out >
```

3. Press and hold in the INPUT Knob until the following appears on the Display.

```
Data Out: PORT 1 >  
All Data >
```

4. Rotate the VOLUME Knob to select “UNBAL 1” Input.

```
Data Out: PORT 1 >  
< UNBAL 1 >
```

5. In a similar manner, perform steps 3 and 4 to assign any additional Data Ports.
6. Exit the Data Out Setup Menu by pressing the INPUT Knob.

External Control Setup Menu

Settings	Options
Front IR	Enabled, Disabled
RS232 Baud Rate	115200 Baud
IR Codes	Normal, Alternate

IR Codes

The Remote Control included with the MSA5500 utilizes the NORMAL McIntosh Control Codes. The Second Set of Control Codes the MSA5500 will respond to is referred to as the ALTERNATE Codes. The Alternate Codes are used when the MSA5500 is used in the same location as another McIntosh Preamplifier and/or A/V Processor. This will prevent the Remote Control from affecting the operation of both units at the same time. To activate the Remote Control ALTERNATE Codes perform the following steps:

1. Use the INPUT Knob to enter the External Control Setup Menu.
2. Rotate the INPUT Knob until the following appears on the Information Display.

```
Ext Ctrl: < IR Codes
          < Normal
```

3. Rotate the VOLUME Knob to the Alternate Codes.

```
Ext Ctrl: < IR Codes
          Alternate >
```

4. It is now necessary to change the HR085 Remote Control over to the Alternate Codes. Information on the HR085 Remote Control is available for download from the McIntosh website.
5. Exit the External Control Setup Menu by pressing the INPUT Knob.

Front IR

The MSA5500 Front Panel Sensor, which receives the signals from the HR085 Remote Control, can be switched off to prevent interference when an external IR Sensor is connected. To de-activate the Front Panel IR Sensor perform the following steps:

1. Use the INPUT Knob to enter the External Control Setup Menu.
2. Rotate the INPUT Knob until the following appears on the Information Display.

```
Ext Ctrl: Front IR >
          < Enabled
```

3. Rotate the VOLUME Knob to select "Disabled".

```
Ext Ctrl: Front IR >
          Disabled >
```

4. Exit the External Control Setup Menu by pressing the INPUT Knob.

RS232 Baud Rate

The MSA5500 may be remotely controlled from other equipment connected to the Rear Panel RS232 Jack. The speed at which the MSA5500 communicates (8 bit, no parity and 1 stop bit) with other equipment is adjustable from 9,600 bits per second to 115,200 bits per second. To change from the default speed of 115,200 bits per second, perform the following steps:

1. Use the INPUT Knob to enter the External Control Setup Menu.
2. Rotate the INPUT Knob until the following appears on the Information Display.

```
Ext Ctrl: < RS232 >
          < 115200 Baud
```

3. Rotate the VOLUME Knob to select the desired Baud Rate Speed.
4. Exit the External Control Setup Menu by pressing the INPUT Knob.

Browser Interface

Another way to change the settings for the MSA5500 is to use the Browser Interface. To open the Browser Interface you just need to go on your computer and enter the IP address for the MSA5500. To view the IP address for the MSA5500, see the “Network Setup Menu” on page 17.

Browser Interface Menus

The Browser Interface contains the following menus:

- Overview
- Settings
- Update

Overview Menu

The Overview Menu contains the following:

Settings	Options
Model Name	MSA5500
Custom Name	
Serial Number	
Mac Address	
Network IP Address	
Network status	
Firmware Product	Firmware Version Information

You can provide a Custom Name for the MSA5500. This is the name that will display for available AirPlay devices. If you wish to change the default name, type the new name in the box and press Enter. If the name was changed using the Apple Home app, the name will not be able to be changed on the web page.

Settings Menu

The Settings Menu contains the following:

Settings	Options
Startup Volume Limit	ON, OFF
Power Save	Disabled, Enabled
Network Type	Automatic, Wired, Wireless

When the **Startup Volume Limit** is ON, upon power loss or return to play from Sleep or Standby, the first playback of the product will start at a low volume level. When switched to OFF, the product will resume playback at the last volume level. The Settings Menu allows you to change settings for Wired and Wireless network connections.

If **Power Save** is Enabled, the MSA5500 will power off into a sleep state after approximately 30 minutes of no sound or user input. After 45 minutes of uninterrupted sleep, the MSA5500 will enter a Standby Mode. If the Standby key is pressed the MSA5500 will enter Sleep state for 15 minutes, and then will enter Standby. In this Standby Mode, the Wi-Fi radio is powered off and the unit can not be woken via the network. Standby Mode power consumption is less than 0.5 watts.

If **Power Save** is Disabled, the MSA5500 will power off into a sleep state after 30 minutes of non-activity. The MSA5500 can be woken from sleep by input from the network (or physically pushing the Power Button). In a sleep state, the MSA5500 will continue to work with devices configured to control it in your Google Home collection. The MSA5500 can be made to immediately enter a sleep state by pressing the red button on the Front Panel.

If Network Type is set to Automatic, the MSA5500 will automatically connect to Wi-Fi when the ethernet cable is unplugged provided the Wireless

connection has previously been setup. Selecting Wired for Network Type will limit the MSA5500 network connection to the ethernet port connection. Select Wireless to setup a Wi-Fi network or to restrict the network connection to Wi-Fi.

If you selected the Network Type of Wireless, the following submenus appear:

- Scan Networks
- Display SSID
- Network Password

Update Menu

The Update Menu contains the following:

Settings	Options
Factory Reset	Start Factory Reset
Update Method	Service, OTA Auto, OTA Manual
Authorization Code	

To restore Factory settings, select the “Start Factory Reset” button. Done. Note that you will lose your Wi-Fi and Bluetooth connection settings. An alternative method for Factory Reset, is via the System Setup Menu, see page 14. Update Method allows you to set how the MSA5500 updates its firmware. When set to the default of OTA Auto, the MSA5500 will periodically check for updates and install them automatically. When set to OTA Manual, the MSA5500 will check for available updates when you select the Start Search button to the right of Check for Update. If an update is available, you can install it by selecting Start Update. (OTA stands for “over-the-air”.) The Service option for updating is for service purposes by a McIntosh qualified technician only. While the MSA5500 is in the process of updating the firmware, various messages will be displayed on the VFD. This is normal.

Passthru Connection Diagram

The MSA5500 can be part of a Multichannel Sound System for Blu-ray Audio, DVD Audio and Home Theater Movies. The Right and Left Front Channels from an Audio/Video Control Center can “Passthru” the MSA5500. In the following example the UNBAL 4 Input will become the “Passthru” input:

1. Connect Audio Cables from the A/V Processor FL (Front Left) and FR (Front Right) Channel Outputs to the MSA5500 UNBALANCED Number 4 INPUTS Left and Right Jacks.
2. Connect a Control Cable from the A/V Processor TRIGGER 2 Output to the MSA5500 POWER CONTROL PASSTHRU INPUT Jack.

Note: Refer to Passthru on page 14 to assign the UNBAL 4 INPUT as the “Passthru” Input.

3. Proceed to “Connecting Loudspeaker” on page 7.

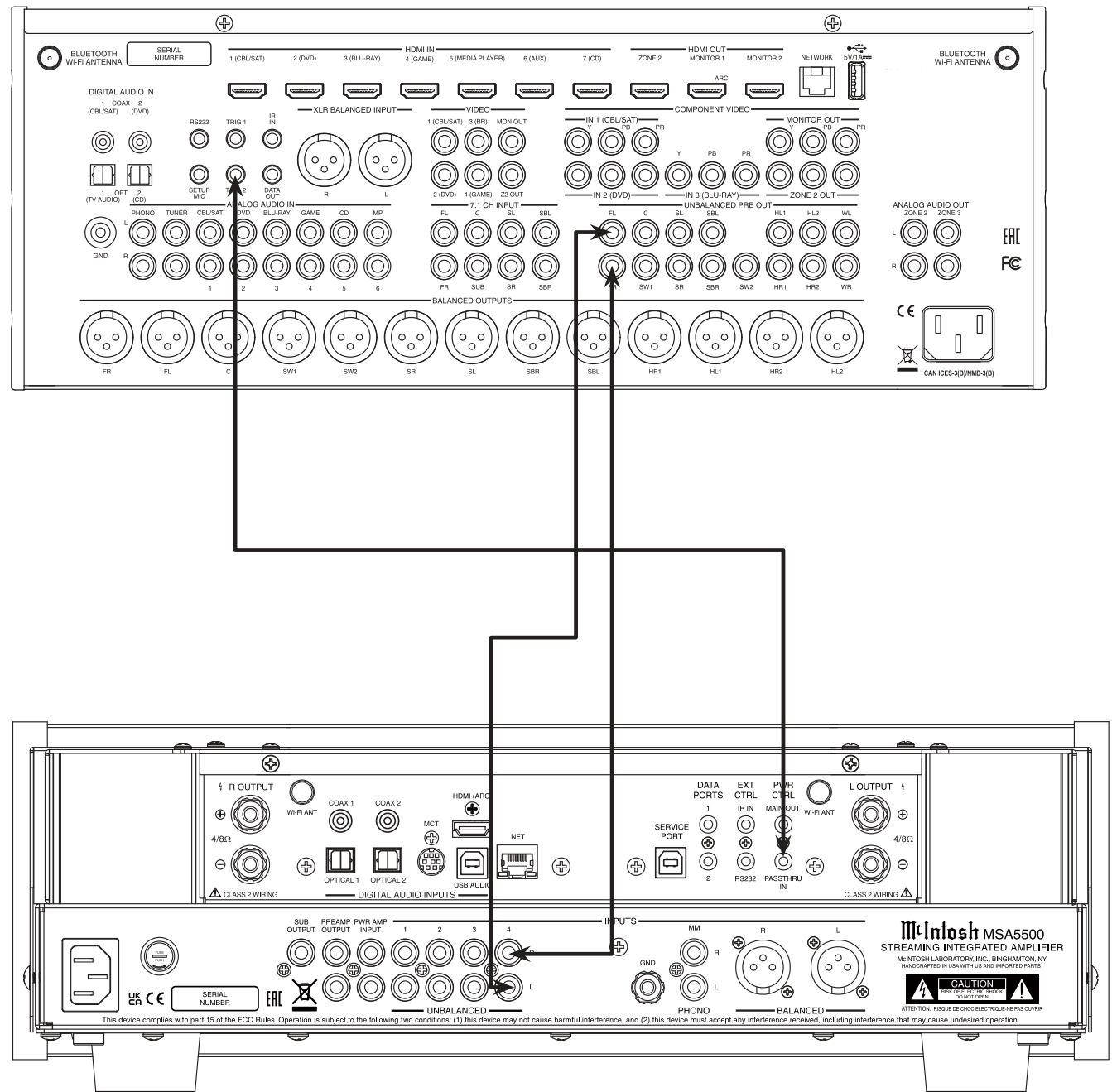

Bi-Amplification Connection Diagram

The MSA5500 Power Amplifier, together with an additional separate Power Amplifier, may be used to Bi-Amplify a Loudspeaker System. In the illustration on this page, the Power Amplifier of the MSA5500 is connected to the Midrange/High Frequency Section of the Loudspeaker. The additional separate Power Amplifier is connected to the Low Frequency Section of the Loudspeaker System.

Warning: *The Loudspeaker System used for Bi-Amplification must have the jumpers removed from between the MID/HIGH and LOW Frequency Sections of the Loudspeaker System. Failure to remove them could result in damage to the MSA5500 and/or the separate Power Amplifier.*

MSA5500 Connections:

1. Remove the “McIntosh Jumpers” from between the PREAMP Jacks and the PWR AMP In Jacks located on the Rear Panel of the MSA5500. Place the “McIntosh Jumpers” in a safe place for possible future use.
2. Using a pair of shielded RCA Type Audio “Y” Adapters connect the PREAMP Jacks to the PWR AMP In Jacks, for both Left and Right Channels on the MSA5500.
3. Connect the remaining unconnected part of the “Y” Adapters to the separate Power Amplifier.
4. Refer to “Connecting a Loudspeaker” on page 7 and the Owner’s Manual supplied with the Power Amplifier and Loudspeaker to connect the MSA5500 Output Terminals to the Loudspeaker MID/HIGH Input Terminals.

Note: The Loudspeaker Connection illustrations on this page are for the Left Channel. Connect the Right Channel Loudspeaker in the same manner.

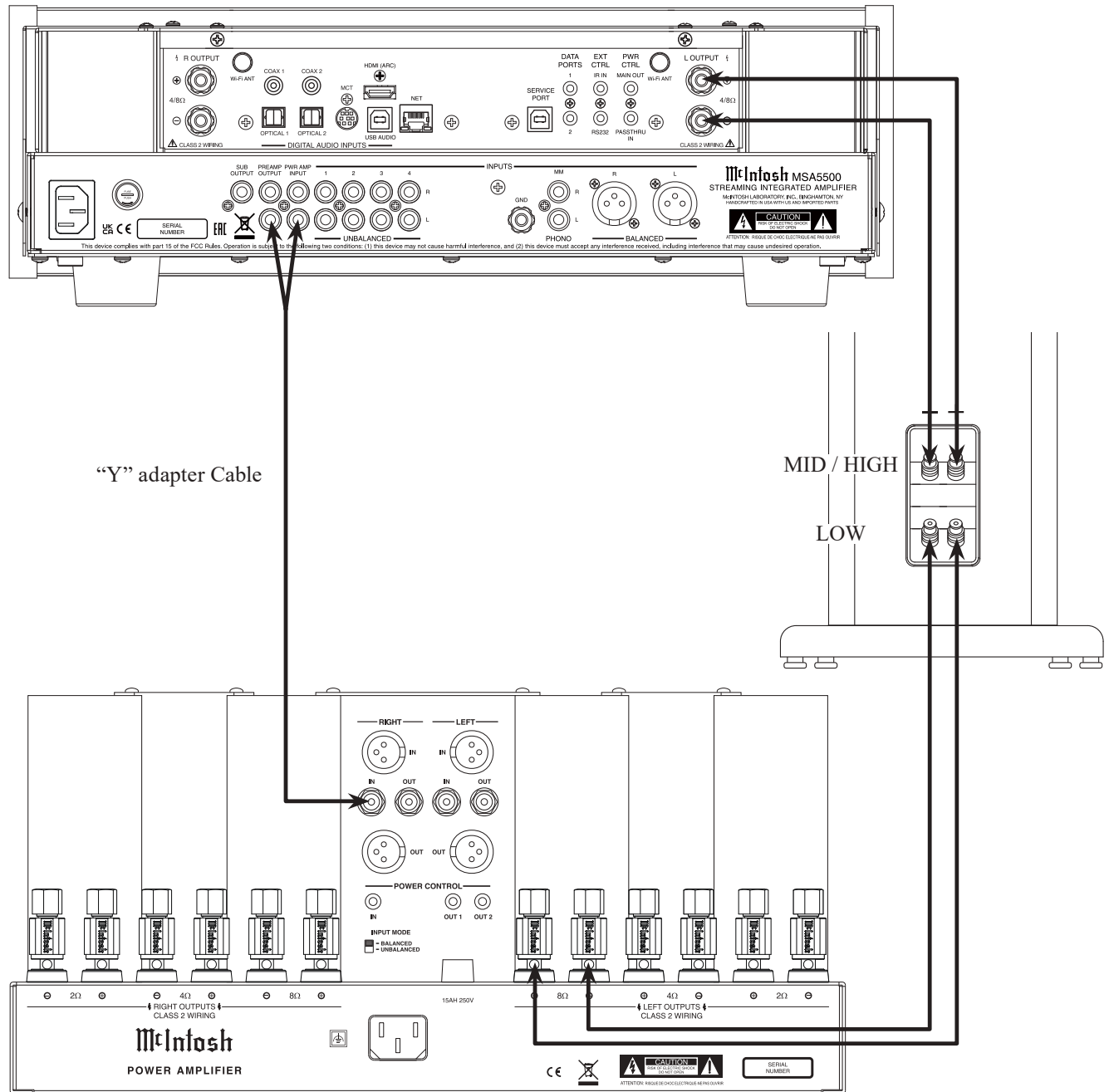

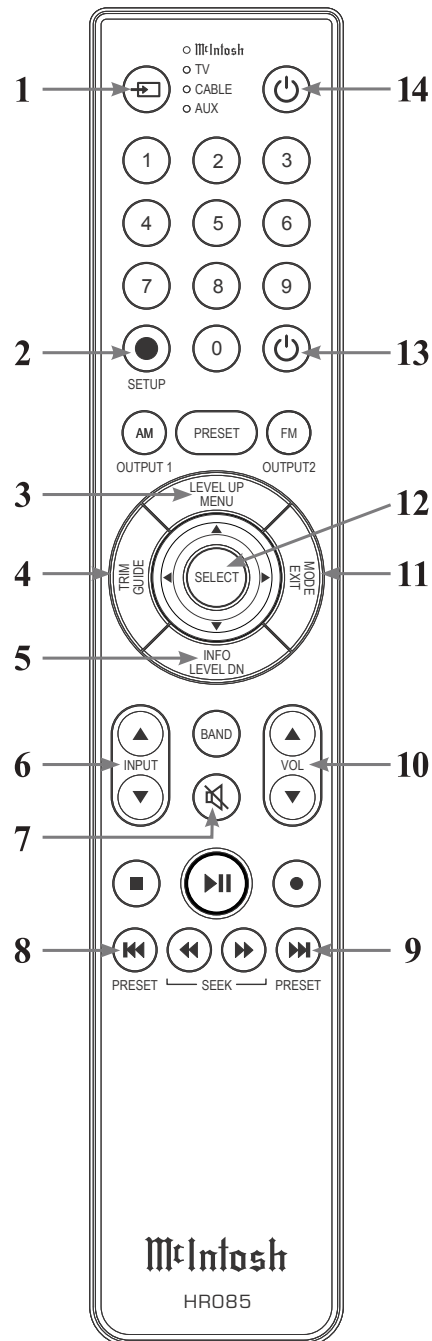

Navigating the Remote Control

- 1. Switch Device:** Select different devices for remote operation. Selected device is indicated by the LED light.
- 2. Setup Button:** Used to enter setup mode.
- 3. Level Up/Menu:** Accesses menu on compatible devices.
- 4. Trim/Guide:** Enters trim functions menu. Opens guide on compatible devices.
- 5. Info/Level Down:** Accesses info on compatible devices.
- 6. Input:** Changes and selects different inputs.
- 7. Mute:** Mutes audio playback.
- 8. Previous/Previous Preset:** Return to your previous media selection.
- 9. Next/Next Preset:** Jump to your next media selection or navigate to the next tuner preset.
- 10. Volume:** Used to adjust the volume.
- 11. Mode/Exit:** This will exit the trim functions menu. It will also display information or certain options.
- 12. Select:** Selects the highlighted option.
- 13. Power Off:** Turns off the selected device shown by the LED.
- 14. Power On:** Turns on the selected device shown by the LED.

Note: The HR085 Remote Control has buttons used to control multiple devices. Buttons whose function are not described are for use with other McIntosh products.

For more information, refer to the HR085 Owner's Manual on the McIntosh website at www.mcintoshlabs.com

Remote Control Batteries

The HR085 Remote Control included with the MSA5500 is powered by two AAA batteries (not included). To insert or remove batteries, open the battery compartment by removing the cover located on the back of the remote control. To open, pull the clasp located just above the opening downward.

Additional Discrete Commands

Additional discrete commands for external control systems are available:

- BALANCED
- UNBAL 1,2,3,4
- PHONO MM
- COAX 1,2
- OPT 1,2
- USB
- MCT
- HDMI (ARC)
- Power (Cycle)

These additional commands can be accessed using an optional McIntosh HR093 Service Remote Control. You can also contact McIntosh Technical Assistance or your dealer for more information.

How to use the Remote Control

The supplied MSA5500 Remote Control (HR085) is capable of directly controlling the functions of contemporary McIntosh Source Components connected to the MSA5500 via the Data Ports.

Note: If the MSA5500 seems unresponsive to the HR085 Remote Control Commands, press the  DEVICE Button to select McIntosh first.

Trim

Press the TRIM Button until the desired Trim function (Balance, Trim Level, etc.) appears on the MSA5500 Front Panel Display, then press the LEVEL Up or Down Button to adjust the Trim setting.

Pressing the TRIM Button once will recall the last Trim function selected. For additional information on using the Trim Functions refer to the following page.

Mute

Press the MUTE Button to mute the audio in all outputs except the SEND OUTPUT. The word MUTE will appear on the Front Panel Information Display. To un-mute the audio, press the MUTE Button again.

Disc, Server and Tape Functions

Use these buttons to operate a DVD Player, CD Player, CD Changer, Music Server or Recorder.

Disc and Track

Use the AM (disc) and FM (track) Buttons when a Disc Player or Music Server is being used.

Volume

Press the Up ▲ or Down ▼ VOLUME Button to raise or lower the listening volume level.

Trim Functions Menu

The Trim Settings are stored in memory independently for each Input Source Selected, except the Meter Illumination and Display Brightness settings of On or Off, which are the same for all inputs.

How to Select and Adjust Trim Functions

1. Press the Front Panel INPUT Knob to open the Trim Menu.
2. Rotate it to select the desired Trim Function.
3. Rotate the VOLUME Knob to change the setting.

Note: The Remote Control TRIM Button together with the LEVEL UP / LEVEL DN Button may also be used to access and change Trim Functions.

Approximately 5 seconds after making any changes, the Information Display will return to indicate the Source Selection and Volume Level.

Settings	Options
Balance	L, Center, R
Input Trim	-6dB to +6dB in 1dB intervals
Tone Control	On, Off
Bass	Off, -12dB to 12dB in dB intervals
Treble	Off, -12dB to 12dB in dB intervals
Mono/Stereo Mode	Stereo, Mono
Meter Lights	On, Off
Brightness	4 Levels from Dim → Bright
HXD Mode*	On, Off

Note: HXD Mode will only appear if headphones are plugged in.

Trim Functions Menu (continued)

Trim Functions Menu Options

Balance

Listening balance varies with different program sources, room acoustics and listening positions relative to the loudspeakers. Use the Balance (Trim Function) as needed to achieve approximately equal listening volume levels in each loudspeaker.

The Front Panel Display indicates the Balance changes are from 0 to 50 dB. After approximately 4 seconds the Information Display returns to indicate the Source Selection and Volume Level. To verify the Balance setting without changing it, use the TRIM Button and select Balance.

Input Trim Level

Source Components can have slightly different volume levels resulting in the need to readjust the MSA5500 VOLUME Knob when switching between different sources. The MSA5500 allows the adjustment of levels for each of the Source Inputs for the same relative volume.

Tone Control

With the Tone Controls are On, the Treble and Bass Trim Settings may be adjusted for the currently selected input source. When the Tone Controls are Off, the previous settings for Treble and Bass are bypassed from the signal path.

- **Bass**
The intensity of the low frequencies in the music can be increased or decreased by using the Trim Select and Trim Adjust controls.
- **Treble**
The intensity of the high frequencies in the music can be increased or decreased by using the Trim Select and Trim Adjust Control.
- **Mono/Stereo Mode**
By default, the Stereo Mode is active for all Input Sources however, any Input Source may be assigned to the Mono Mode of operation. To change Stereo Mode to Mono for a given Input Source, perform the same type of steps by using the Front Panel Controls or the Remote Control buttons as done for TONE CONTROL Settings:

Meter Illumination

The Meter Illumination of McIntosh Power Amplifiers, when connected to the MSA5500, may be switched On or Off.

Information Display Illumination

The brightness level of the Front Panel Information Display can be adjusted. It has 4 levels that vary from dim to bright.

HXD Mode

When headphones are connected to the MSA5500 Front Panel Jack, an additional TRIM function becomes available. McIntosh's HXD brings the acoustical depth and spatiality of music normally heard with loudspeakers, to your headphones.

Note: The Headphone Output is optimized for impedances ranging from 100 to 600 ohms.

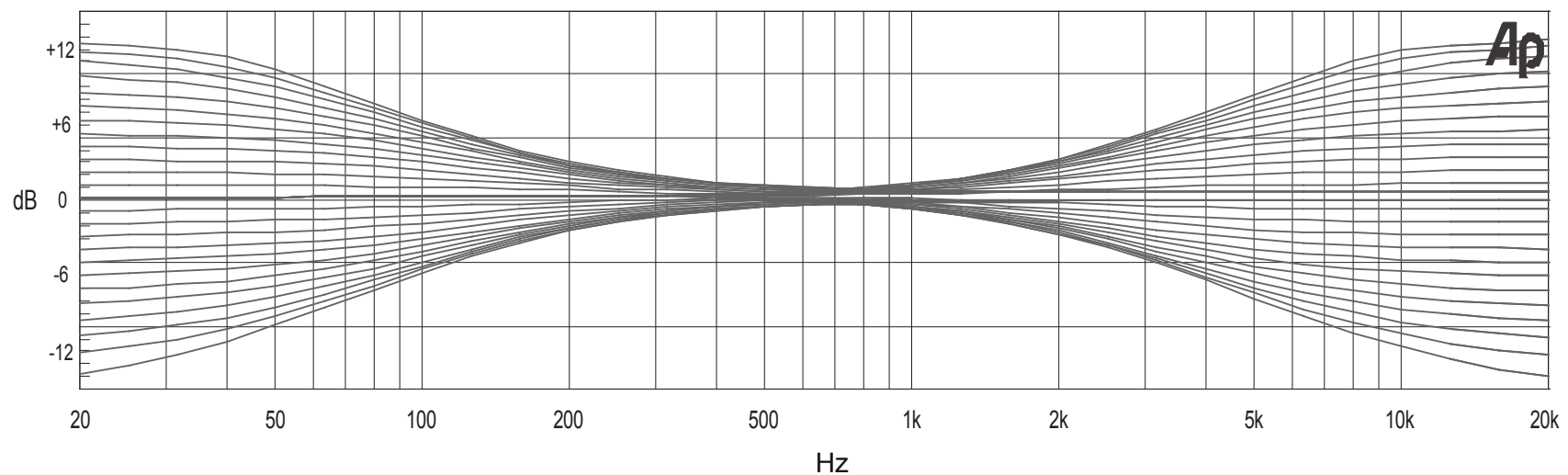

General Specifications

Power Requirements

Field AC Voltage conversion of the MSA5500 is not possible. The MSA5500 is factory configured for one of the following AC Voltages:

100 Volts, 50/60Hz at 3.7 amps
110 Volts, 50/60Hz at 3.4 amps
120 Volts, 50/60Hz at 3.2 amps
220 Volts, 50/60Hz at 1.8 amps
230 Volts, 50/60Hz at 1.6 amps
240 Volts, 50/60Hz at 1.6 amps

Standby: Less than 0.25 watt

Note: Refer to the rear panel of the MSA5500 for the correct voltage.

Overall Dimensions

Width

17 ½ inches (44.4cm)

Depth

18 ¾ inches (47.6cm) with vertical antennae
22 ¼ inches (56.5cm) with horizontal antennae

Height

6 inches (15.2cm) including feet
8 ⅛ inch (20.6cm) including feet
and vertical antennae

Weight

38 pounds (17.2 kg) net
55.5 pounds (25.2 kg) in shipping carton

Shipping Carton Dimensions

Width is 26 ½ inches (67.3cm)
Depth is 24 ¼ inches (62.2cm)
Height is 11 ¾ inches (29.9cm))

Amplifier Specifications

FTC Power Output Rating

100 watts

Power Output

Minimum sine wave continuous average power output per channel, with both channels operating is:
100 watts into 8 ohm load
160 watts into 4 ohm load

Output Load Impedance

8 or 4 ohms

Rated Power Band

20Hz to 20,000Hz

Total Harmonic Distortion

0.005% maximum with both channels operating from 250 milliwatts to rated power, 20Hz to 20,000Hz

Intermodulation Distortion

0.005% maximum, if the instantaneous peak power is 400 watts or less per channel with both channels operating for any combination of frequencies from 20Hz to 20,000Hz

Dynamic Headroom

1.8dB

Wide Band Damping Factor

Greater than 200 - 8 ohm
Greater than 100 - 4 ohm

Power Guard

Less than 2% THD with up to 16dB overdrive at 1,000Hz

Frequency Response

+0, -0.5dB from 20Hz to 20,000Hz
+0, -3dB from 10Hz to 100,000Hz

Preamplifier Output (at rated input)

1.4V unbalanced (8V Maximum)

Sensitivity (for rated output)

High Level - 250mV unbalanced, 500mV balanced
Phono MM - 2.5mV
Power Amp In - 1V (8 ohm load)

Signal To Noise Ratio (A-Weighted)

High Level - 95dB below rated output
Phono MM - 82dB below 5mV input
Power Amplifier - 110dB below rated output

Input Impedance

High Level - 20K ohms
Phono MM - 47K ohms; 50pF

Preamplifier Output Impedance

220 ohms

Maximum Input Signal

High Level - 8V unbalanced, 16V balanced
Phono MM - 80mV
Power Amplifier In - 8V

Headphone Impedance

100 to 600 ohms

Voltage Gain

High Level to Preamp Output: 15dB
Phono MM to Preamp Output: 55dB
Power Amplifier: 29dB

Power Control Output

12VDC, 25mA

Digital Audio Specifications

Digital Input Signal Format

Coaxial / optical inputs - SPDIF (PCM), and bitstream

MCT - SACD, PCM

USB Audio - DSD, DXD, PCM

HDMI - PCM, Dolby Digital, DTS

Digital Input Sample Rates

Optical: PCM 16-bit, 24-bit 44.1-192kHz

Coaxial: PCM 16-bit, 24-bit 44.1-192kHz

MCT: PCM, SACD, 16-bit, 24-bit 44.1-192kHz

USB: PCM 16-bit, 24-bit, 32-bit 44.1-192kHz

DXD DXD352.8kHz, DXD384kHz

DSD DSD64, DSD128, DSD256, DSD512

HDMI: PCM 24-bit, 44.1-192kHz, bitstream

Digital Inputs

Coaxial: 0.5V p-p/75 ohms

Optical: -15dbm to -21dbm (TOS Link)

MCT: 0.5V p-p/75 ohms

USB Audio 2.0: USB Type B Connector

HDMI: 2.0 ARC

Streaming Support

Apple AirPlay, Google Cast, Spotify Connect, Tidal Connect, Roon

Supported Audio Formats

(Must also be supported by chosen source app and device)

MP3, AAC, FLAC, ALAC, WMA, Ogg Vorbis,

WAV, M4A, OGG, AIFF

Connectivity

Wi-Fi CERTIFIED™ a, b, g, n, ac

WPA™, WPA2™, WMM®

2.4/5 GHz, Ethernet

Bluetooth 5.0

AVRCP, A2DP, aptX, aptX HD, aptX Adaptive

Packing Instructions

In the event it is necessary to repack the equipment for shipment, the equipment must be packed exactly as shown below.

It is very important that the four plastic feet are attached to the bottom of the equipment. This will ensure the proper equipment location on the bottom pad. Failure to do this will result in shipping damage.

Use the original shipping carton and interior parts only if they are all in good serviceable condition. If a shipping carton or any of the interior part(s) are needed, please call or write Customer Service Department of McIntosh Laboratory. Refer to page 3.

Please see the Part List below for the correct part numbers.

Qty	Part Number	Description
1	033838	Shipping carton
2	034669	End Caps
1	033836	Inner carton
1	033725	Top pad
1	034576	Bottom pad
1	034480	Wood skid
2	017218	Plastic feet (spacer)
2	401204	#10 x 2 ½ inch wood screws
2	404033	#10 flat washers 1-¾ inch
4	017937	Plastic feet
4	400159	#10-32 x ¾ machine screws
2	404033	#10 flat washers

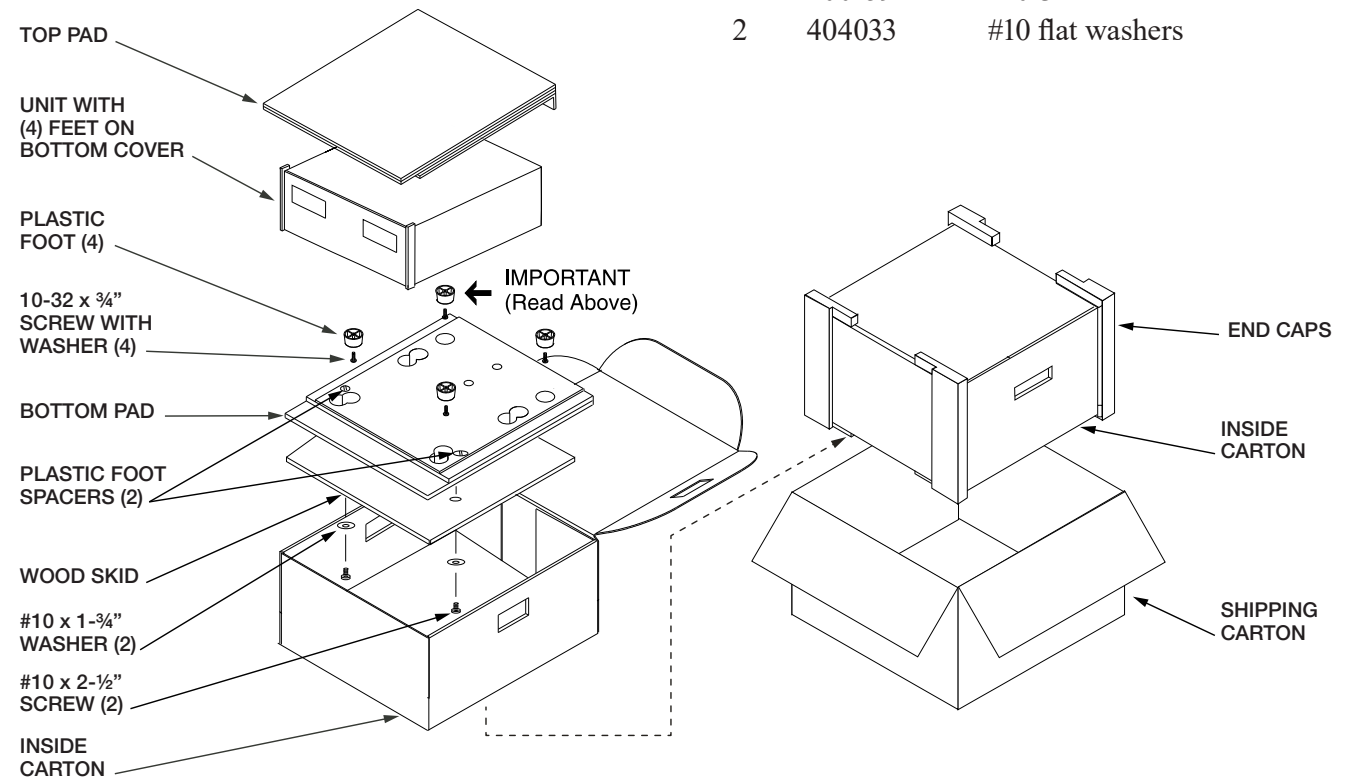

McIntosh®

MADE OF SOUND™

McIntosh Laboratory, Inc.
2 Chambers Street
Binghamton, NY 13903
www.mcintoshlabs.com

The continuous improvement of its products is the policy of McIntosh Laboratory Incorporated who reserve the right to improve design without notice. The MSA5500 is designed to employ non-McIntosh-provided services some of which require separate customer subscriptions and some of which do not, as part of the Product's functionality. Because McIntosh cannot control the providers of such services or the services themselves, the owner of the Product therefore assumes all risks related to the use of services provided by anyone other than McIntosh itself. McIntosh cannot and does not warrant against, and shall have no liability of any kind for any of the following that are attributable to non- McIntosh providers or services: (i) interruption, discontinuance, or other unsatisfactory performance of service; (ii) reduced Product functionality that is so attributable; or (iii) any other loss or damage of any kind that is so attributable.

Printed in the U.S.A.

© 2024 McIntosh Laboratory, Inc.
McIntosh Part No. 24124800