



TRUE RESIDENTIAL®

15 INCH AND 24 INCH UNDERCOUNTER
INSTALL GUIDE AND USER'S MANUAL
“C” REVISION



PRESERVE THE MOMENT®



838155-H

INSTALLATION CHECKLIST

To ensure no part of the installation process has been overlooked, complete the checklist below.

- Have all packaging materials been removed?
- Are the anti-tip brackets securely installed and properly engaging the unit?
- Has the unit been properly leveled? Do all leveling legs touch the floor?
- Is the kickplate installed?
- Are panels attached securely and properly aligned? (overlay appliances only).
- Is the doorstop being installed (if needed; stainless steel models)?
TRUE offers a 90° door stop option for stainless steel units. If a 90° door stop is required, please contact your dealer or True Customer Service at 888-616-8783.
- Does the customer understand the unit's operation?
- Has the customer been given the key and literature package?
- Have all stainless steel surfaces been inspected for imperfections?*
- Is the unit operating correctly? If not, is the unit plugged in? Is the control turned on?

*To be completed by either an installer with the customer or an authorized True dealer upon completion of installation. Stainless steel doors, handles, and shelves are covered by a limited 30-day warranty for cosmetic defects.

TRUE'S TECHNICAL SERVICE YOUTUBE CHANNEL

For more in-depth installation and service information, see our Technical Service YouTube Channel at <https://www.youtube.com/@TrueManufacturingService>.

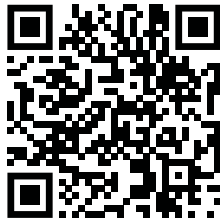

THANK YOU

FOR YOUR PURCHASE

NOTE: AS WE STRIVE FOR CONTINUOUS IMPROVEMENTS, FEATURES AND SPECIFICATIONS ARE SUBJECT TO CHANGE WITHOUT NOTICE.

INSTALLATION CHECKLIST	2	PRIOR TO INSTALLATION	
TRUE'S TECH SERVICE YOUTUBE CHANNEL	2	ANTI-SWEAT FOAM END PANELS	12
		OUTLET POSITIONING	12
SAFETY INFORMATION & OWNERSHIP		ROUGH OPENING—SOLID & GLASS DOOR	13
REFRIGERANT SAFETY & WARNING INFO	6	ROUGH OPENING—STACKED UNITS	14
BASIC SAFETY & WARNING PRECAUTIONS	6	PLAN VIEWS	15
APPLIANCE DISPOSAL WARNING	7	CUSTOM PANEL SPECIFICATIONS	25
OWNERSHIP	8	DOOR OVERLAY PANEL INSTALLATION	30
NOTICE TO CUSTOMER	8	DRAWER OVERLAY PANEL INSTALLATION	32
REGISTER YOUR PRODUCT	8	WINE RACK HANDLE & OVERLAY PANEL FINISH APPLICATION	34
APPLIANCE LOCATION	8	STACKING KIT INSTALLATION	37
OUTDOOR USE	8	ELECTRICAL INSTALLATION & SAFETY	40
CONTACT INFORMATION	9		

CONTENTS

INSTALLATION

UNCRATING	44
ANTI-TIP BRACKET INSTALLATION	45
LEVELING	47
120° DOORSTOP INSTALLATION (STAINLESS STEEL ONLY)	47
KICKPLATE INSTALLATION	48
90° HINGE INSTALLATION (OPTIONAL; STAINLESS STEEL ONLY)	48

APPLIANCE SETUP

GLASS SHELF ADJUSTMENT	52
WINE RACK ADJUSTMENT	52
DRAFT STANDARD INSTALL & HOOK UP	54
DRAFT STANDARD INSTALL (COUNTERTOP)	57
DRIP TRAY INSTALLATION	59
DISPENSING PRESSURE	60
TAPPING	60
CHANGING CO ₂ GAS CYLINDER	60
CO ₂ REGULATOR PRESSURE ADJUSTMENT	61
DRAFT TOWER CLEANING	62

APPLIANCE OPERATION

TRUE PRECISION CONTROL® OPERATION & APPLIANCE COMPONENTS (ALL MODELS)	66
24 INCH REFRIGERATOR & FREEZER	66
24 INCH DUAL ZONE	72
24 INCH REFRIGERATOR / FREEZER DRAWERS	74
15 INCH REFRIGERATOR	78
HOME ALARM SYSTEM (DUAL ZONE WINE CABINET ONLY)	81

MAINTENANCE & SERVICING

CONDENSER COIL CLEANING	84
INTERIOR ACCESSORIES	85
CONDENSATION	85
DRAWER REMOVAL, INSTALLATION & ADJUSTMENT	86
APPLIANCE CARE & CLEANING	88
SERVICING & REPLACING COMPONENTS	90
HANDLE TIGHTENING	90
CONTACT INFORMATION	90
SERIAL LABEL LOCATION	90

FREQUENTLY ASKED QUESTIONS

GENERAL QUESTIONS	92
BEVERAGE DISPENSER QUESTIONS	93
WINE APPLIANCE QUESTIONS	95
DRAWER APPLIANCE QUESTIONS	95

WARRANTY

WARRANTY	96
----------	----

OWNERSHIP

REFRIGERANT SAFETY & WARNING INFORMATION

BASIC SAFETY & WARNING PRECAUTIONS

PROPER DISPOSAL OF THE APPLIANCE

NOTICE TO CUSTOMER

REGISTER YOUR PRODUCT

CONTACT INFORMATION

OUTDOOR USE



PRESERVE THE MOMENT®



WARNING! Use this appliance for its intended purpose as described in this Installation Manual.

This appliance is to be installed in accordance with local and federal regulations, as well as Safety Standard for Refrigeration Systems ANSI/ASHRAE 15.

REFRIGERANT SAFETY & WARNING INFORMATION

See the serial label inside the appliance for the units refrigeration type. For Hydrocarbon Refrigeration (R-600a only), see below:



DANGER! Risk of fire or explosion. Flammable refrigerant used.

- **DO NOT** use mechanical devices to accelerate the defrost process or to clean.
- **DO NOT** puncture, pierce, or burn refrigerant tubing.
- Be aware that refrigerants may not contain an odor.
- Store the appliance in a room without continuously operating ignition sources.
- Follow handling instructions carefully.
- To be repaired only by trained service personnel.
- Consult repair manual/owner's guide before attempting to service this product. All safety precautions must be followed.
- Dispose of properly in accordance with local and federal regulations. Follow all safety precautions.



CAUTION! Keep all ventilation openings clear of obstruction in the appliance enclosure or in the structure housing the appliance.

BASIC SAFETY & WARNING PRECAUTIONS

- Take care during operation, maintenance or repairs to avoid cuts or pinching from any part/component of the appliance.
- Units may pose a tipping hazard while uncrating, during installation, or when moving the unit.
- Ensure the unit is properly installed and located in accordance with the Installation Instructions before use.
- This appliance is not to be used, cleaned or maintained by persons (including children) with reduced physical, sensory or mental capabilities or lack of experience and knowledge, unless they have been given supervision or instruction.
- **DO NOT** allow children to play with the appliance or climb, stand, or hang on the unit's shelves to prevent damage to the refrigerator and personal injury.
- **DO NOT** touch the cold surfaces in the freezer compartment when hands are damp or wet. Skin may stick to these extremely cold surfaces.
- Unplug the refrigerator before cleaning and making repairs.
- Setting temperature controls to the 0 position or powering off an electronic control may not remove power from all components (e.g., light circuits, perimeter heaters, and evaporator fans).
- **DO NOT** store or use gasoline, or other flammable vapors and liquids, in the vicinity of this or any other appliance.

- **DO NOT** store explosive substances such as aerosol cans with a flammable propellant in this appliance.
- Keep fingers out of the "pinch point" areas; clearances between the doors and appliance are necessarily small; be careful closing doors when children are in the area.
- **DO NOT** use electrical appliances inside the food storage compartments of the units unless the appliances are of the type recommended by the manufacturer.

NOTE: ALL SERVICING MUST BE PERFORMED BY A QUALIFIED TECHNICIAN.

APPLIANCE DISPOSAL WARNING



DANGER! RISK OF CHILD ENTRAPMENT



Child entrapment and suffocation are not problems of the past. Junked or abandoned appliances are still dangerous, even if they will sit for "just a few days." If you are getting rid of your old appliance, please follow the instructions below to help prevent accidents.

Before throwing away your old appliance:

- Take off the doors.
- Leave the shelves in place so that children may not easily climb inside.



DANGER! Risk of fire or explosion. Flammable insulation and/or refrigerant used. Dispose of all in accordance with local and federal regulations. Follow all safety precautions.

OWNERSHIP

To ensure that your unit works properly from the first day, it must be installed properly. We highly recommend a trained refrigeration mechanic and electrician install your True equipment. The cost of a professional installation is money well spent.

Before you start to install your TRUE unit, carefully inspect it for freight damage. **IF DAMAGE IS DISCOVERED, DO NOT INSTALL THE UNIT OR PUT IT IN SERVICE.** Notify True customer service, and immediately file a claim with the delivery freight carrier.

TRUE is not responsible for damage incurred during shipment.

For any questions about installation, please contact your True dealer or True Residential Technical Support at **844-746-9423** or **TrueResidentialService@TrueMfg.com**. Please have your model and serial number available.

NOTICE TO CUSTOMER

Loss or spoilage of products in your refrigerator/freezer is **not covered by warranty**. In addition to following recommended installation procedures, run the refrigerator/freezer for 24 hours prior to usage to verify its proper operation.



REGISTER YOUR PRODUCT

To qualify for TRUE's extended 7–12 year parts only sealed system warranty, you must register your product* within 12 months of the unit's installation date. To register your unit, complete and submit the form at **<https://true-residential.com/product-registration>**. For warranty details, please see pg. 96.



* Please note that ice machines do not qualify for this extended warranty.

APPLIANCE LOCATION

- This appliance has been tested for UL CSA to ISO Climate Class 5 [104°F (40°C) temperature, 40% relative humidity].
- Appliance is not suitable for outdoor use.
- Higher ambient conditions may reduce the appliance's performance.

OUTDOOR USE

All True undercounter units are rated for outdoor use.

- In regions with high dew points or humidity, condensation may appear on the glass and around gasket seals. For best operation, keep the unit fully stocked with product.
- In areas where the ambient temperature regularly exceeds 95°F (35°C), vent the rear of the rough opening for optimum performance. Recommended vent size is 4" x 10" (102 mm x 254 mm).
- For the best operation, install your True unit with your outdoor bar/kitchen countertop covering the door or drawer gasket (flush install). The rough opening should be at least 24" (606.6 mm) deep.

NOTE: DOOR AND DRAWER GASKETS DO NOT PROVIDE A WATERTIGHT SEAL AGAINST THE ELEMENTS.

WINTERIZING

When the temperature consistently reaches 32°F (0°C) or below, winterize your unit.

1. Remove all product from the unit.
2. Unplug the unit or turn the unit off.
3. Place a cover over the unit.

CONTACT INFORMATION

For any questions about installation, please contact your TRUE dealer or TRUE Residential Technical Support. Please have your **model** and **serial number** (see serial label location below) available so we can better assist you with your service- or parts-related inquiries.

Customer Service

Phone: 888-616-8783
info@true-residential.com

Technical Support Department

Phone: 844-746-9423
TrueResidentialService@truemfg.com

Warranty Department

Phone: 844-849-6179
TrueResidentialWarranty@truemfg.com

SERIAL LABEL LOCATION

Your serial label contains important information such as your model name and serial number. The label is located on the upper left interior wall.

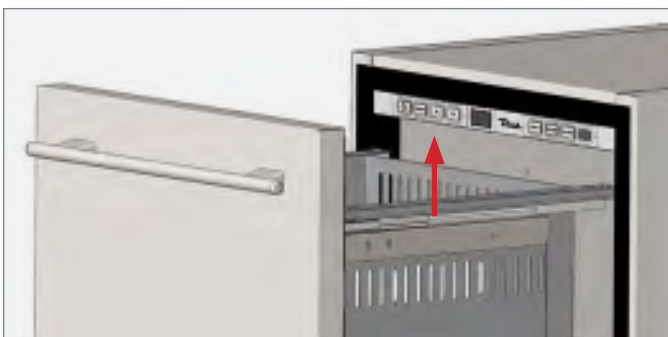

PRIOR TO INSTALLATION

ANTI-SWEAT FOAM END PANELS

OUTLET POSITIONING

ROUGH OPENING—SOLID & GLASS DOOR

ROUGH OPENING—STACKED UNITS

PLAN VIEWS

CUSTOM PANEL SPECIFICATIONS

DOOR OVERLAY PANEL INSTALLATION

DRAWER OVERLAY PANEL INSTALLATION

WINE RACK HANDLE & OVERLAY PANEL FINISH APPLICATION

STACKING KIT INSTALLATION

ELECTRICAL INSTALLATION & SAFETY



PRESERVE THE MOMENT®

ANTI-SWEAT FOAM END PANELS

When installing two or more True units side-by-side, TRUE recommends installing one (1) foam pad between the appliances (on either appliance) to prevent moisture from developing.

To order foam pads, contact our parts department at **844-849-6226** or **TrueResidentialParts@TrueMfg.com**.

OUTLET POSITIONING

To minimize the depth of the cutout opening, the electrical outlet must be positioned as shown below. Outlet must be flush with the wall.

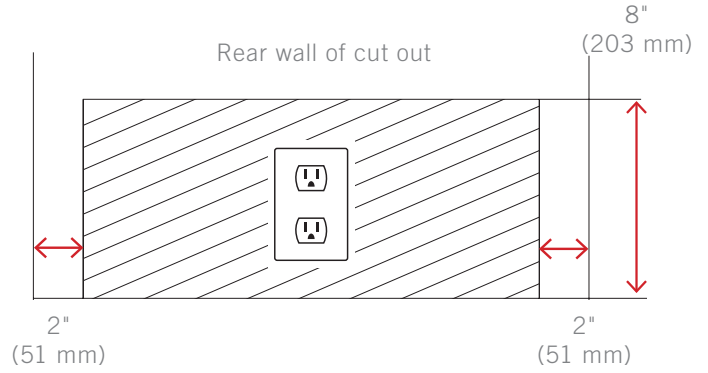

PRIOR TO INSTALLATION

ROUGH OPENING – SOLID & GLASS DOOR

True's Stainless Solid and Glass Door units are designed to be inserted into a cabinet opening or free standing. Below are recommended dimensions for rough opening.

24 INCH

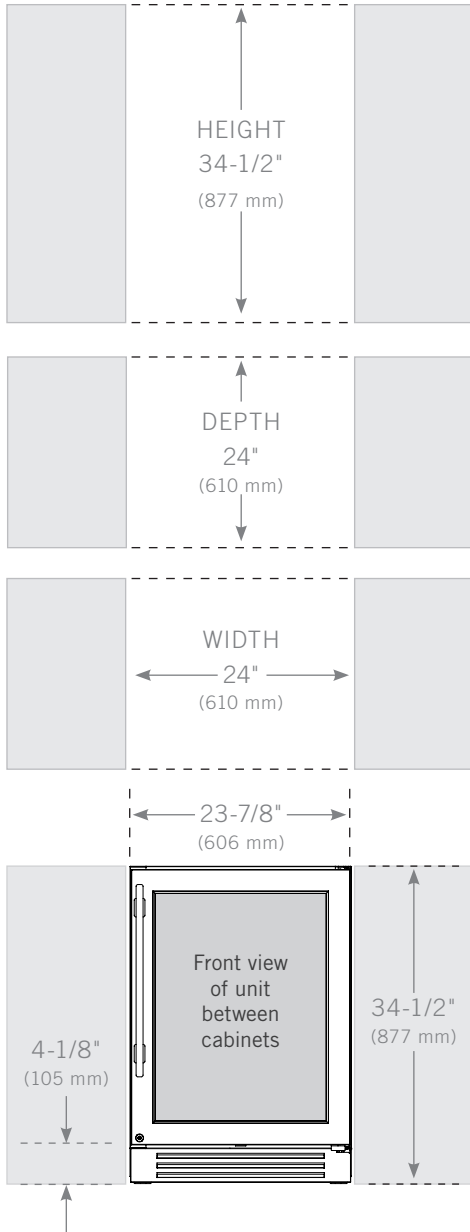

15 INCH



ROUGH OPENING – STACKED UNITS
(SOLID, GLASS DOOR, AND OVERLAY PANELS)

True's stacked units are designed to be inserted into a cabinet opening or free standing. Below are recommended dimensions for rough opening.

24 INCH

15 INCH

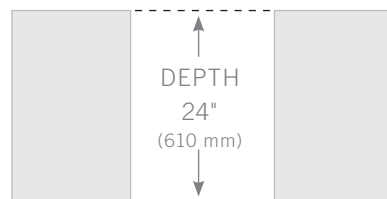
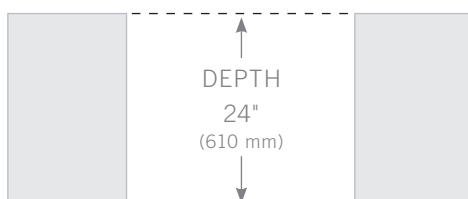
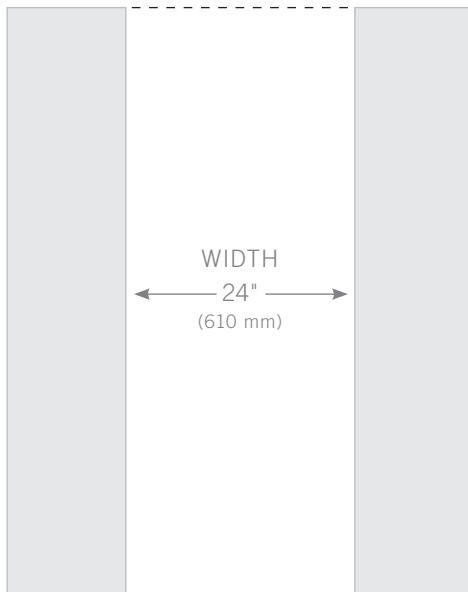
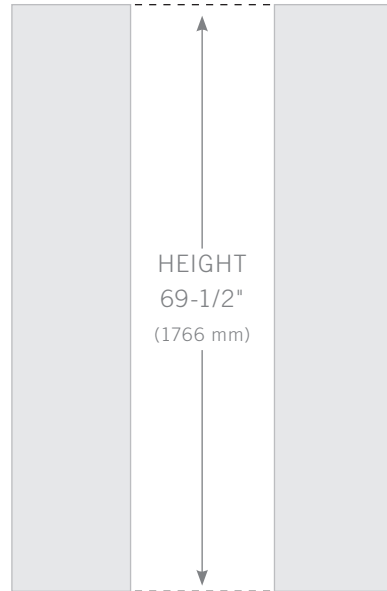
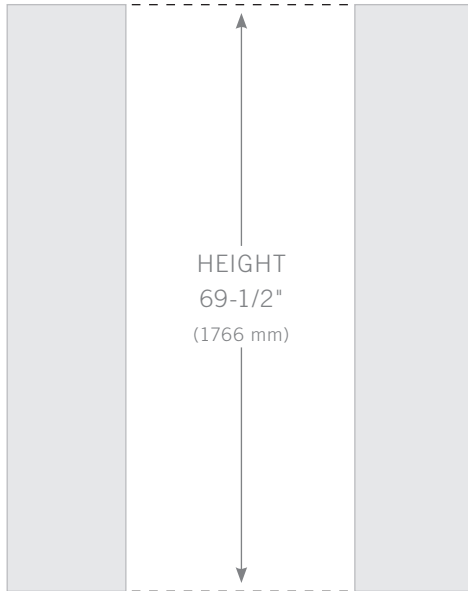

24 INCH

REFRIGERATOR / FREEZER



TUF-24-R/L-SS-C



TUR-24-R/L-SG-C

BEVERAGE CENTER



TBC-24-R/L-SG-C

WINE CABINET



TWC-24-R/L-SG-C

DUAL ZONE WINE CABINET



TWC-24DZ-R/L-SG-C

PLAN VIEW DIMENSIONS

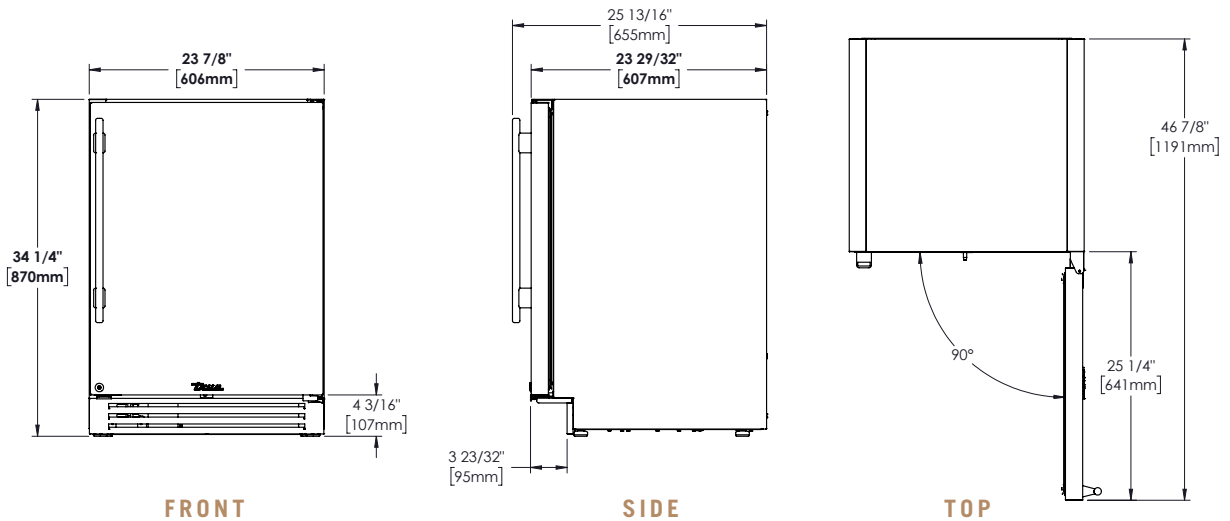

Dimensions may vary by ± 1/8" (3.2 mm)

24 INCH

REFRIGERATOR



TUR-24-D-SS-C

FREEZER



TUF-24-D-SS-C

REFRIGERATOR PLAN VIEW DIMENSIONS

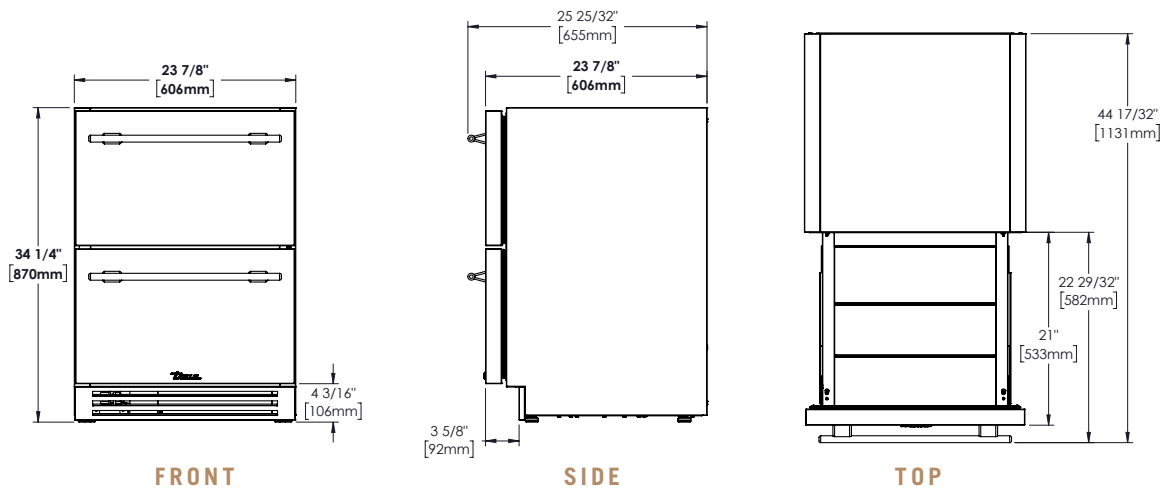

FREEZER PLAN VIEW DIMENSIONS

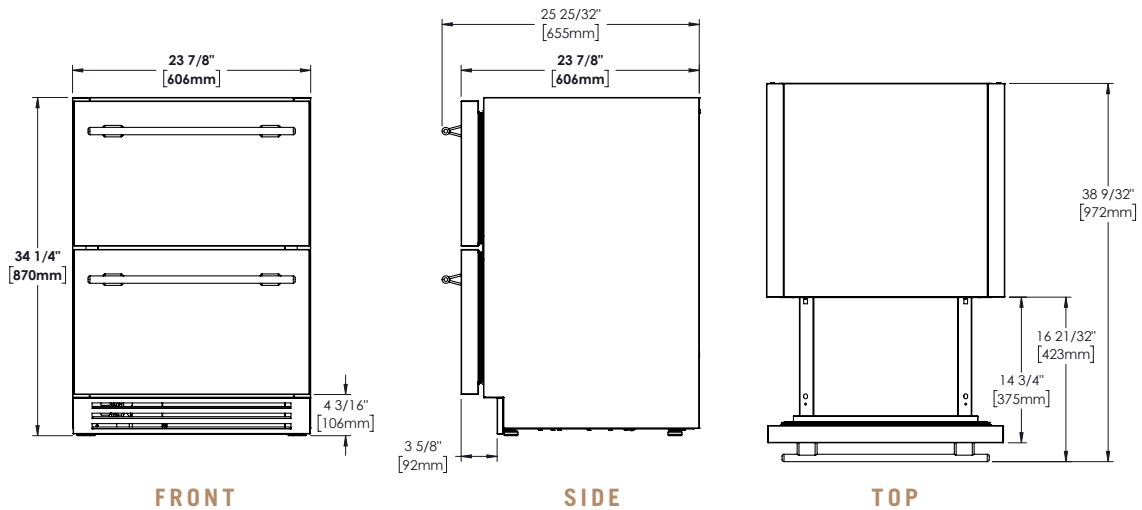

Dimensions may vary by ± 1/8" (3.2 mm)

24 INCH

BEVERAGE DISPENSER



TUR-24BD-R/L-SS-C

TUR-24DD-R/L-SS-C

PLAN VIEW DIMENSIONS

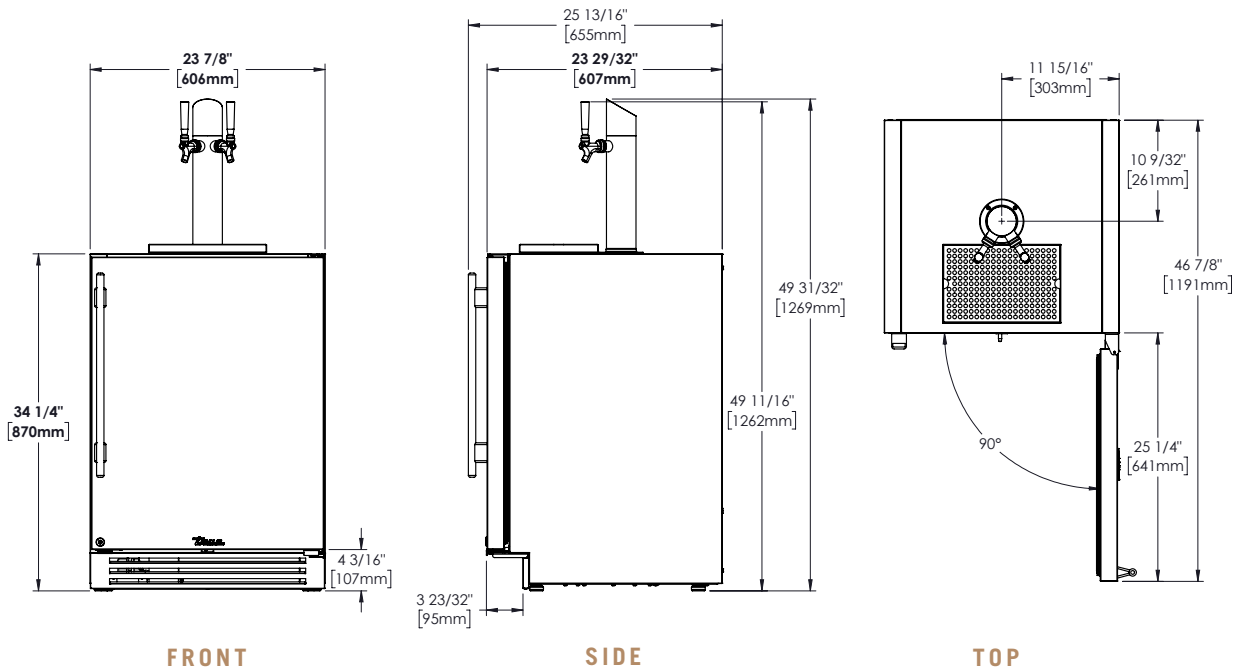

24" SINGLE TAP UNIT ACCOMMODATES (1) SHORT 1/4 BARREL, (1) SLIM 1/4 BARREL, OR (1) 1/6 BARREL.

24" DUAL TAP UNIT ACCOMMODATES (2) 1/6 BARRELS OR (1) SLIM 1/4 BARREL AND (1) 1/6 BARREL.

SEE KEG FOOTPRINTS IN OUR FAQ, STARTING ON PG. 92.

Dimensions may vary by ± 1/8" (3.2 mm)

15 INCH

ALL REFRIGERATORS



TUR-15-R/L-SS-C



TUR-15-R/L-SG-C

WINE CABINET



TWC-15-R/L-SG-C

PLAN VIEW DIMENSIONS

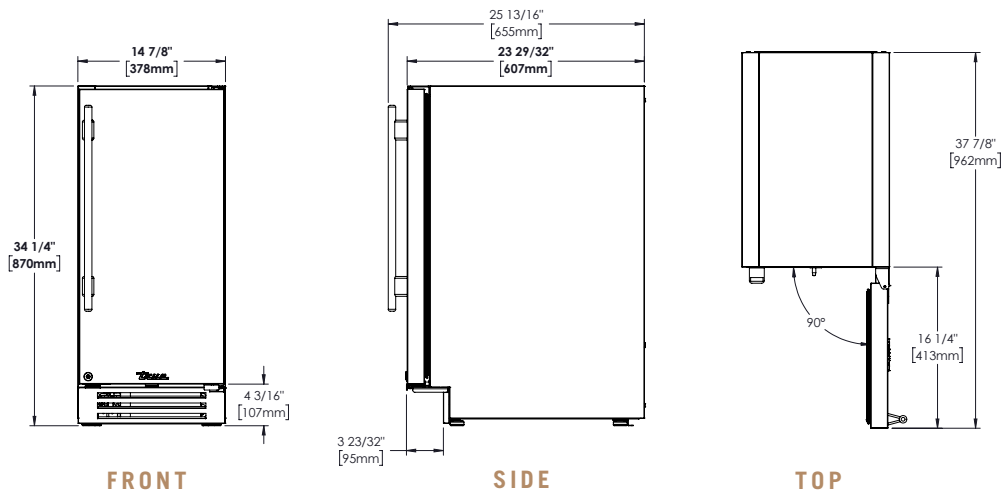

Dimensions may vary by ± 1/8" (3.2 mm)

15 INCH

BEVERAGE DISPENSER



TUR-15BD-R/L-SS-C

PLAN VIEW DIMENSIONS

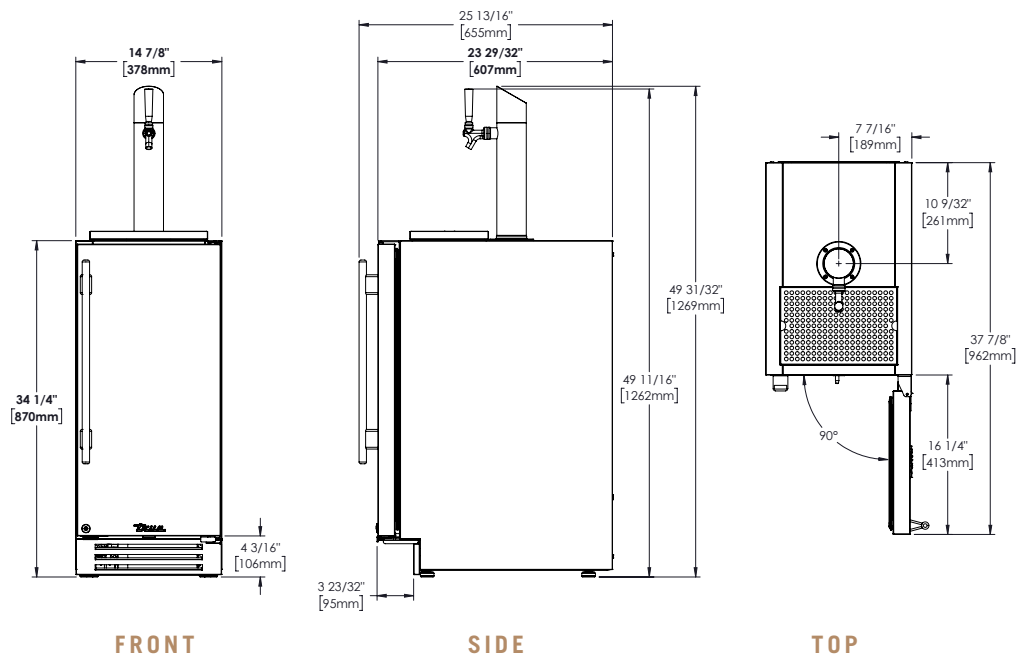

**15" SINGLE TAP UNIT ACCOMMODATES (1) SLIM 1/4 BARREL OR (1) 1/6 BARREL.
SEE KEG FOOTPRINTS IN OUR FAQ, STARTING ON PG. 92.**

Dimensions may vary by ± 1/8" (3.2 mm)

24 INCH

REFRIGERATOR / FREEZER



TUR-24-R/L-OP-C



TUR-24-R/L-OG-C

BEVERAGE CENTER



TBC-24-R/L-OP-C



TBC-24-R/L-OG-C

WINE CABINET



TWC-24-R/L-OP-C



TWC-24-R/L-OG-C

DUAL ZONE WINE CABINET



TWC-24DZ-R/L-OP-C



TWC-24DZ-R/L-OG-C

NOTE: Unit shown with overlay panel (not provided by True)

PLAN VIEW DIMENSIONS*

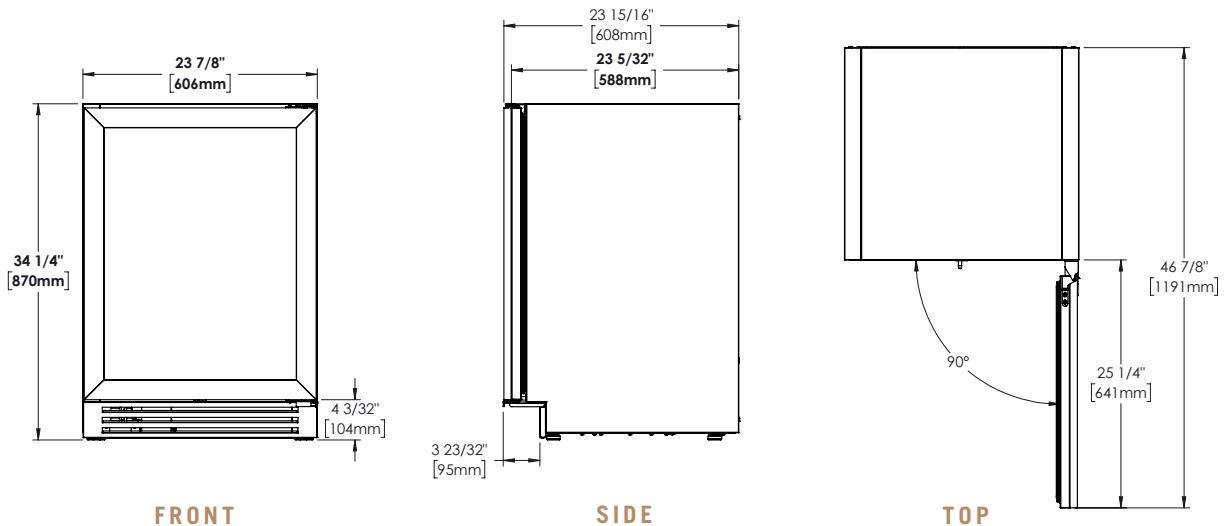

*Depth measurement includes 3/4" thick panel (not provided by TRUE).
Dimensions may vary by ± 1/8" (3.2 mm)

24 INCH

REFRIGERATOR / FREEZER DRAWERS



TUR-24-D-OP-C

TUF-24-D-OP-C

NOTE: Unit shown with overlay panel (not provided by True)

REFRIGERATOR PLAN VIEW DIMENSIONS*

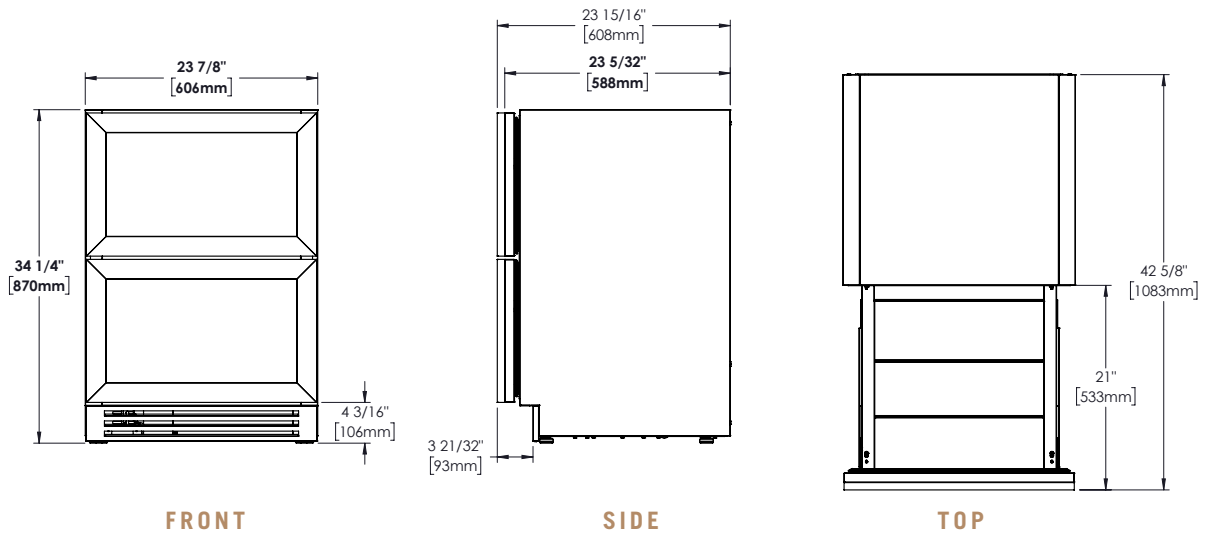

FREEZER PLAN VIEW DIMENSIONS*

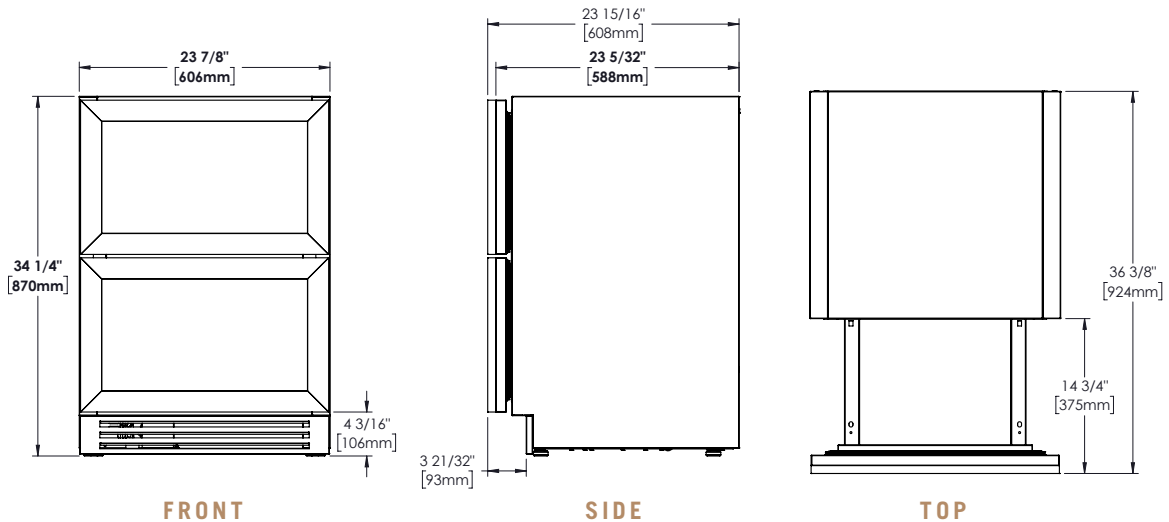

*Depth measurement includes 3/4" thick panel (not provided by TRUE).
 Dimensions may vary by ± 1/8" (3.2 mm)

24 INCH

BEVERAGE DISPENSER



TUR-24BD-R/L-OP-C

TUR-24DD-R/L-OP-C

NOTE: Unit shown with overlay panel (not provided by True)

PLAN VIEW DIMENSIONS*

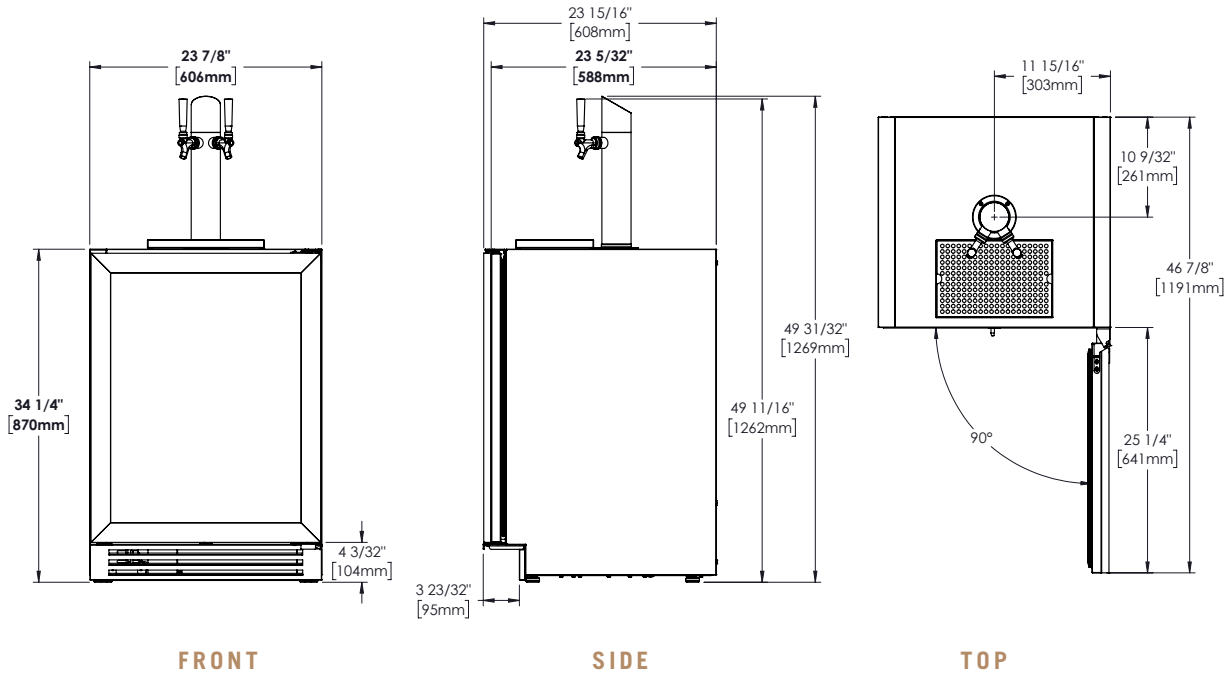

**24" SINGLE TAP UNIT ACCOMMODATES (1) SHORT 1/4 BARREL,
(1) SLIM 1/4 BARREL, OR (1) 1/6 BARREL.**

**24" DUAL TAP UNIT ACCOMMODATES (2) 1/6 BARRELS OR
(1) SLIM 1/4 BARREL AND (1) 1/6 BARREL.**

SEE KEG FOOTPRINTS IN OUR FAQ, STARTING ON PG. 92.

*Depth measurement includes 3/4" thick panel (not provided by TRUE).
Dimensions may vary by ± 1/8" (3.2 mm)

15 INCH

ALL REFRIGERATOR



TUR-15-R/L-OP-C



TUR-15-R/L-OG-C

WINE CABINET



TWC-15-R/L-OP-C



TWC-15-R/L-OG-C

NOTE: Unit shown with overlay panel (not provided by True)

PLAN VIEW DIMENSIONS*

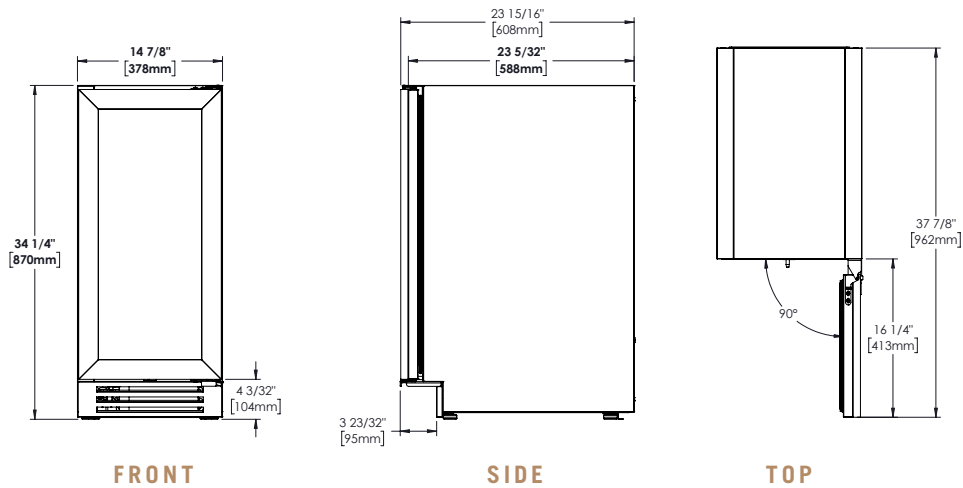

*Depth measurement includes 3/4" thick panel (not provided by TRUE).
Dimensions may vary by ± 1/8" (3.2 mm)

15 INCH

BEVERAGE DISPENSER



TUR-15BD-R/L-OP-C

NOTE: Unit shown with overlay panel (not provided by True)

PLAN VIEW DIMENSIONS*

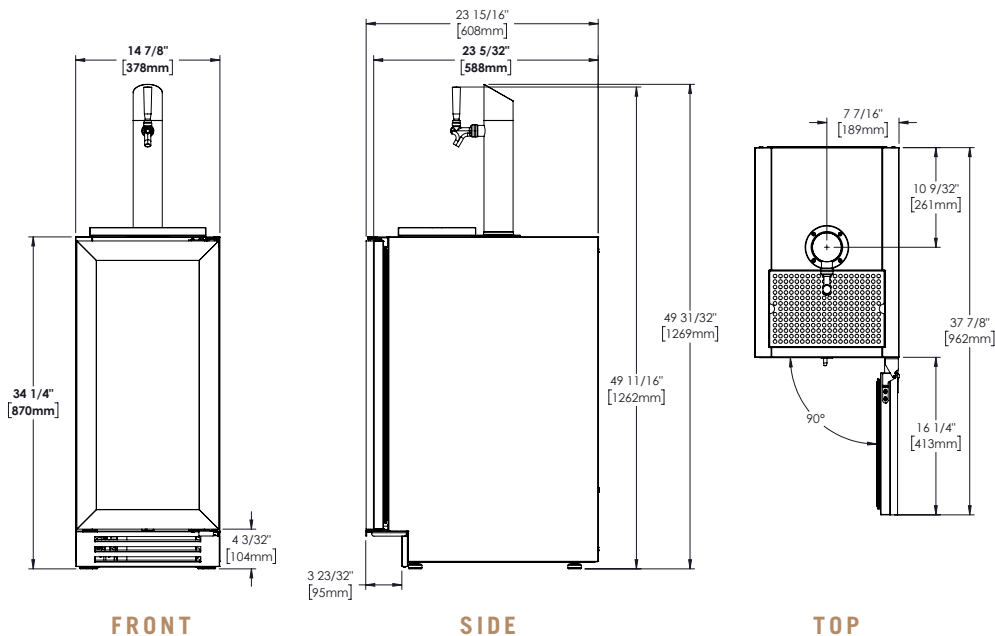

**15" SINGLE TAP UNIT ACCOMMODATES (1) SLIM 1/4 BARREL OR (1) 1/6 BARREL.
SEE KEG FOOTPRINTS IN OUR FAQ, STARTING ON PG. 92.**

*Depth measurement includes 3/4" thick panel (not provided by TRUE).
Dimensions may vary by ± 1/8" (3.2 mm)

CUSTOM PANEL SPECIFICATIONS

Overlay units can be fitted with custom panels to match adjacent cabinetry. Two specification options for panel sizes are given in these instructions for overlay units: Standard overlays and Integrated Panels. The standard overlay panel dimensions fully cover the provided appliance door. The integrated panel options extend above the door and conceal the hinge assembly to match full overlay cabinet doors. See pictures below for reference.

STANDARD OVERLAY PANEL



INTEGRATED OVERLAY PANEL



PRIOR TO INSTALLATION

CUSTOM PANEL SPECIFICATIONS – SOLID DOOR REFRIGERATOR / FREEZER

STANDARD OVERLAY PANEL

24"	IN / LB	MM / KG
Width	23-5/8	600
Height	29-23/32	754.9
Depth	3/4 (max)	19 (max)
Weight	15 lb (max)	6.8 kg (max)
Rail Style Dimension	2 (min)	50.8 (min)
15"	IN / LB	MM / KG
Width	14-5/8	371.5
Height	29-23/32	754.9
Depth	3/4 (max)	19 (max)
Weight	15 lb (max)	6.8 kg (max)
Rail Style Dimension	2 (min)	50.8 (min)

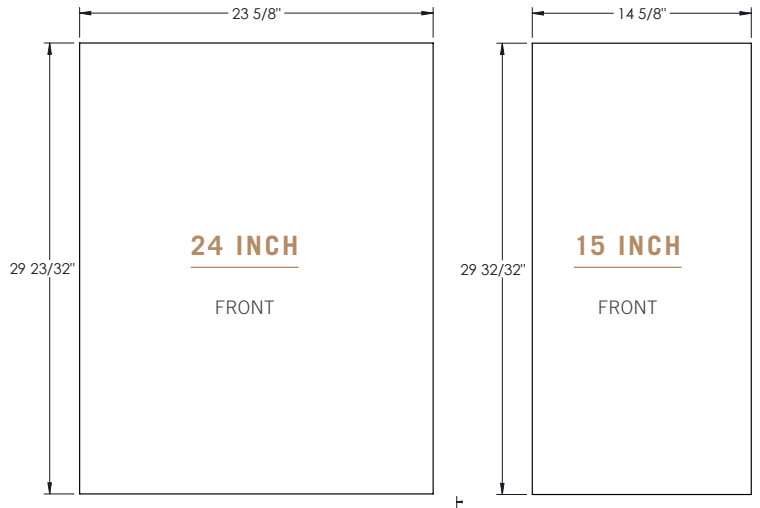

INTEGRATED OVERLAY PANEL

24"	IN / LB	MM / KG
Width	23-5/8	600
Height	30-1/8	765.2
Depth	3/4 (max)	19 (max)
Weight	15 lb (max)	6.8 kg (max)
Rail Style Dimension	2 (min)	50.8 (min)
15"	IN / LB	MM / KG
Width	14-5/8	371.5
Height	30-1/8	765.2
Depth	3/4 (max)	19 (max)
Weight	15 lb (max)	6.8 kg (max)
Rail Style Dimension	2 (min)	50.8 (min)

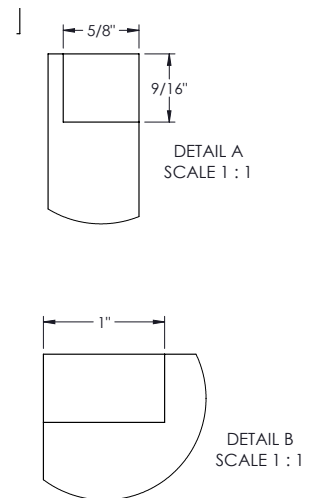
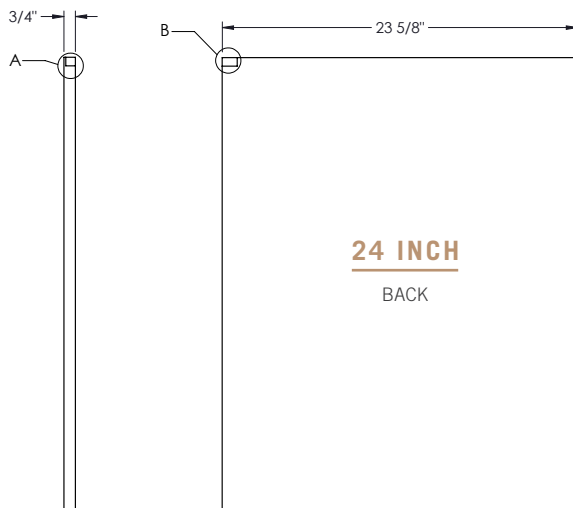
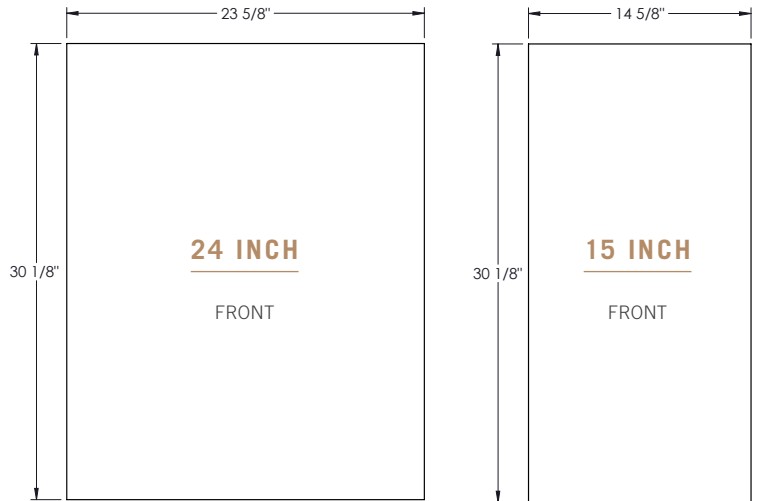

CUSTOM PANEL SPECIFICATIONS – GLASS DOOR REFRIGERATOR

STANDARD OVERLAY PANEL

24"	IN / LB	MM / KG
Width	23-5/8	600
Height	29-23/32	754.9
Depth	3/4 (max)	19 (max)
Weight	15 lb. (max)	6.8 kg (max)
Rail Style Dimension	2 (min)	50.8 (min)
Viewable Area Width	19-5/8	498.5
Viewable Area Height	25-23/32	653.3
15"	IN / LB	MM / KG
Width	14-5/8	371.5
Height	29-23/32	765.2
Depth	3/4 (max)	19 (max)
Weight	15 lb. (max)	6.8 kg (max)
Rail Style Dimension	2 (min)	50.8 (min)
Viewable Area Width	10-5/8	269.9
Viewable Area Height	25-23/32	653.3

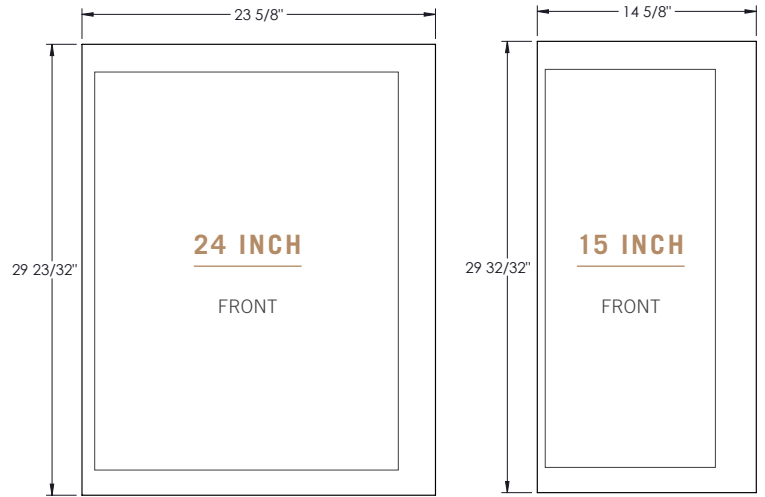

INTEGRATED OVERLAY PANEL

24"	IN / LB	MM / KG
Width	23-5/8	600
Height	30-1/8	765.2
Depth	3/4 (max)	19 (max)
Weight	15 lb. (max)	6.8 kg (max)
Rail Style Dimension	2 (min)	50.8 (min)
Viewable Area Width	19-5/8	498.5
Viewable Area Height	25-23/32	653.3
15"	IN / LB	MM / KG
Width	14-5/8	371.5
Height	30-1/8	765.2
Depth	3/4 (max)	19 (max)
Weight	15 lb. (max)	6.8 kg (max)
Rail Style Dimension	2 (min)	50.8 (min)
Viewable Area Width	10-5/8	269.9
Viewable Area Height	25-23/32	653.3

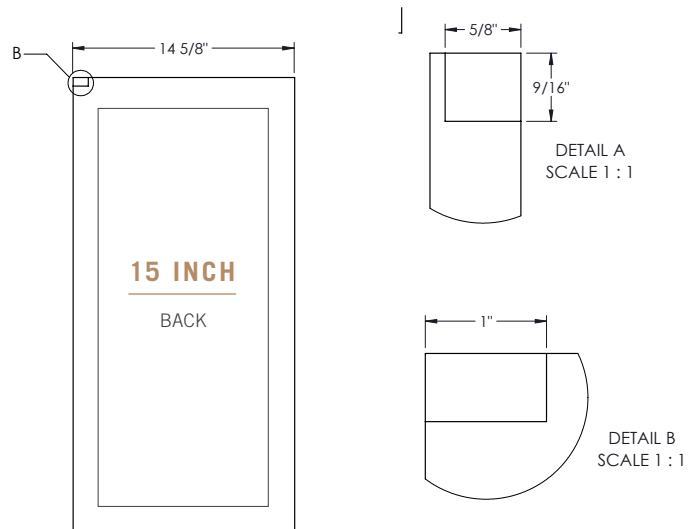
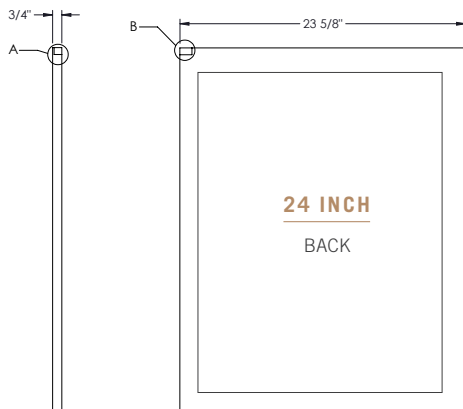
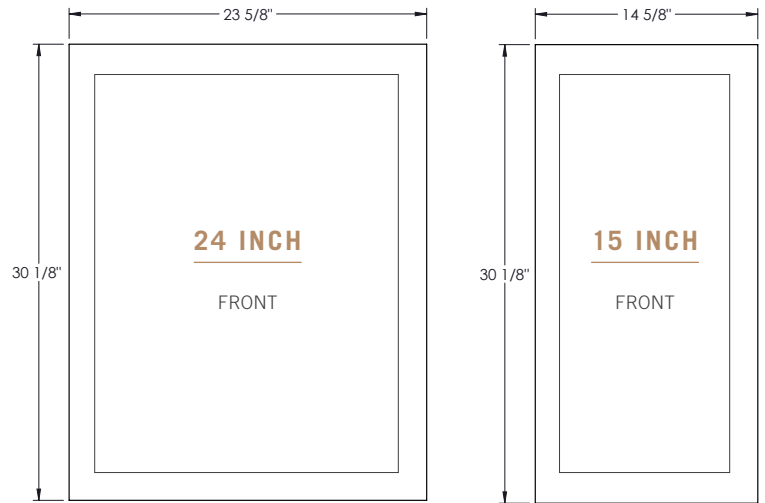

CUSTOM PANEL SPECIFICATIONS – DRAWER REFRIGERATOR / FREEZER

STANDARD OVERLAY PANEL

24"	IN / LB	MM / KG
Width	23-5/8	600
Height	14-11/16	373
Depth	3/4 (max)	19 (max)
Weight	15 (max)	6.8 (max)

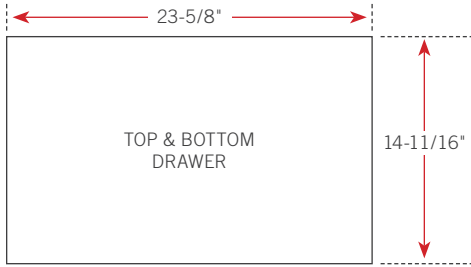

INTEGRATED OVERLAY PANEL

NOTE: TOP DRAWER WILL EXTEND ABOVE APPLIANCE FRONT

24"	IN / LB	MM / KG
Width	23-5/8	600
Top Panel Height	15-1/8	384
Bottom Panel Height	14-11/16	373
Depth	3/4 (max)	19 (max)
Weight	15 (max)	6.8 (max)

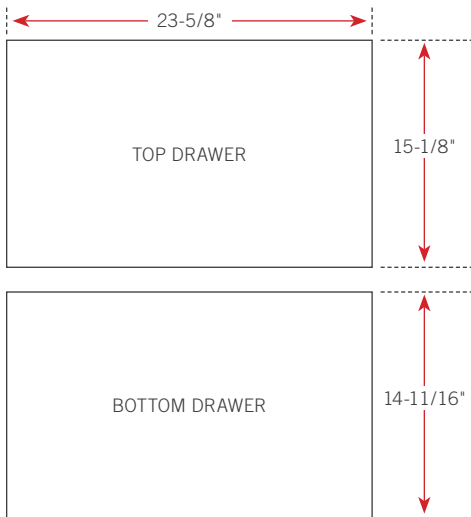

LOUVER TEMPLATE MEASURES

15 INCH

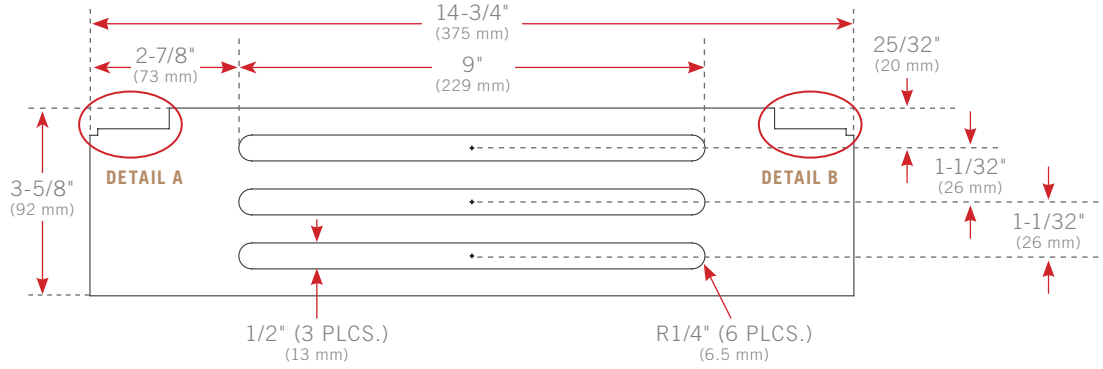

24 INCH

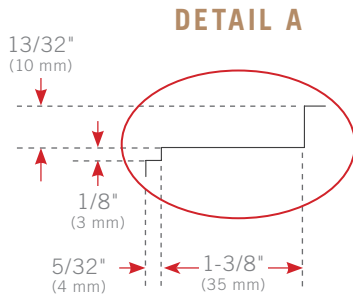
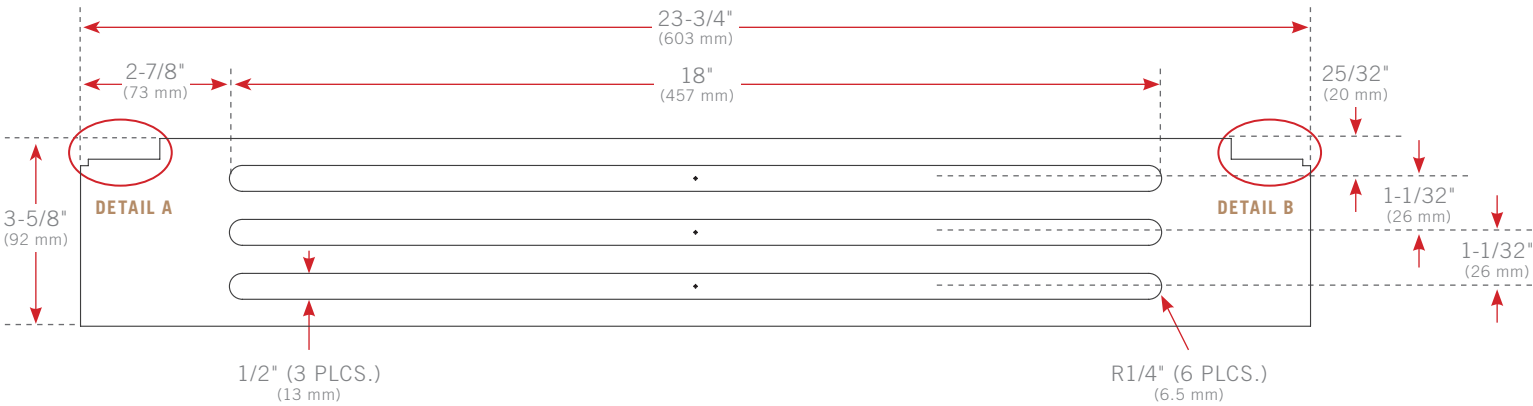

SCALE 2:3
 Notch here for a **left hinged** unit.

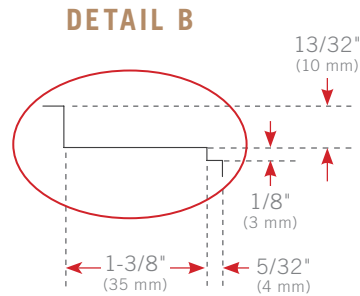

SCALE 2:3
 Notch here for a **right hinged** unit.

DOOR OVERLAY PANEL INSTALLATION

Follow the instructions below to install door overlay panels. Door overlay panel installation is the same for solid and glass door units. For custom panel specifications, please see “Custom Panel Specifications” starting on pg. 25.

NOTE: DO NOT INSTALL A SOLID PANEL ON A GLASS DOOR. THIS MAY CAUSE MOISTURE TO FORM BEHIND THE PANEL, RESULTING IN DAMAGE.

REQUIRED TOOLS

Required tools include (but may not be limited to) the following:

- Surface Protection*
- 3/8" Wrench
- Phillips Bit Driver
- 2+ Clamps $\geq 2"$ (51 mm)
- 1/8" Drill Bit
- #6 Screws (qty 10)**
- Drill

*Cardboard, moving blanket, foam padding, etc.

**To be supplied by the installer. Screw type and length varies by material. All screws must be 1/2" (13 mm) + Overlay Panel Thickness.

PROCEDURE

1. Carefully lay the door overlay panel on a protected surface.
2. Remove the kickplate. See fig. 1.
3. Remove the door from the unit. Leave the hinges installed on the unit. See fig. 2.

NOTE: BE SURE TO SUPPORT THE DOOR WHILE REMOVING THE HINGE HARDWARE. DO NOT DISCARD.

4. Remove the gasket. See fig. 3.
5. With a 1/8" drill bit, carefully drill the pre-marked pilot holes in the door. See fig. 4.
6. Carefully place the door face down on the overlay panel. Align the door and panel edges. See fig. 5.

7. Clamp the door and panel. See fig. 6

NOTE: IF THE CLAMP JAWS ARE NOT PADDED, INSERT PADDING BETWEEN THE CLAMP AND THE OVERLAY TO PROTECT THE PANEL'S FINISH.

IF DESIRED, INSTALL A HANDLE BEFORE PROCEEDING TO THE NEXT STEP. FOR BEST INSTALLATION, FASTEN THE HANDLE WITH RECESSED SCREWS. SEE FIGS. 7 AND 8.

8. Carefully drill pilot holes into the panel. See fig. 6.

NOTE: TAKE CARE TO NOT DRILL THROUGH THE FRONT OF THE PANEL.

9. Fasten the overlay panel to the door front. Then, remove the clamp(s).

10. Install the door gasket.

NOTE: VERIFY THE GASKET IS FULLY SEATED IN THE GASKET CHANNEL.

11. Install the door assembly. Verify the door closes correctly and the gasket seals without gaps.



FIG. 1. Pull the kickplate off the magnets.

PRIOR TO INSTALLATION

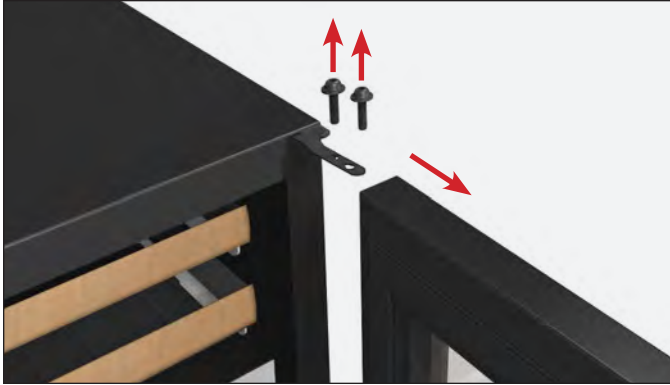

FIG. 2. Remove the hinge bolts from top and bottom hinge

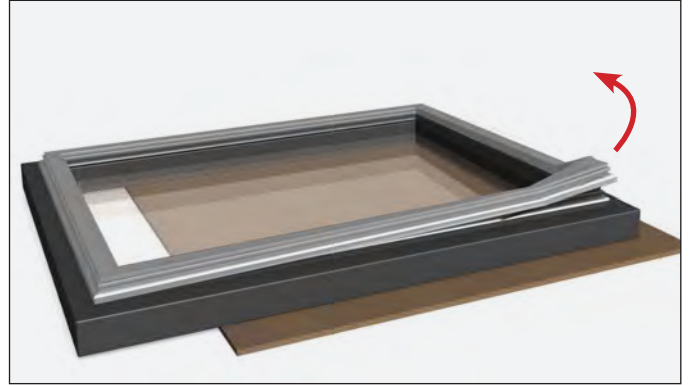

FIG. 3. Pull the gasket from the door.

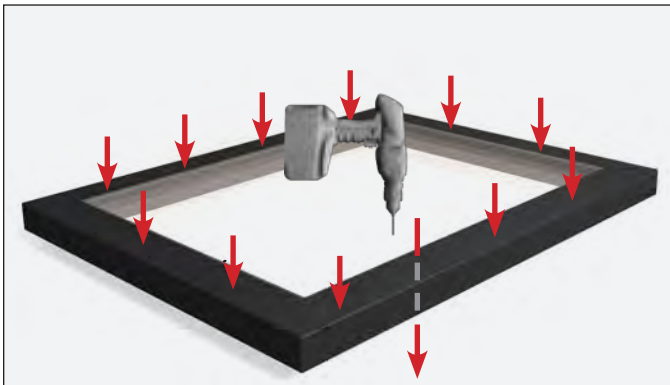

FIG. 4. Drill pilot holes THROUGH the door assembly.

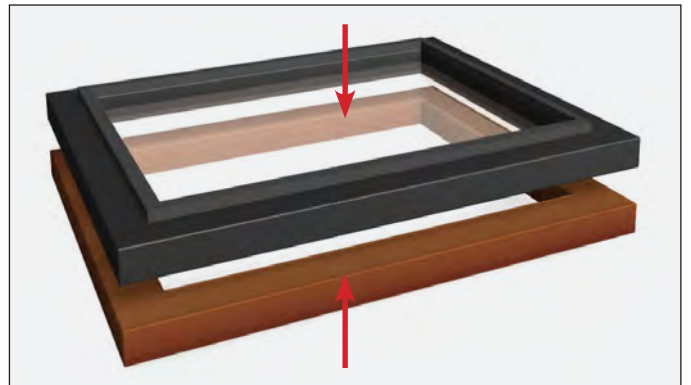

FIG. 5. Be sure the edges are aligned before clamping the panel and door assembly.

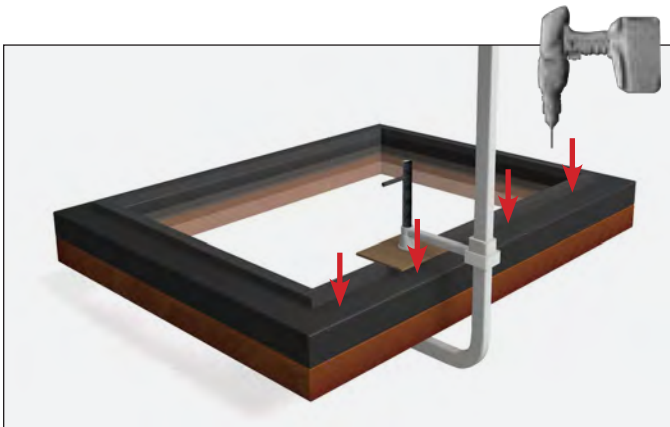

FIG. 6. Be sure to NOT drill through the panel's front.

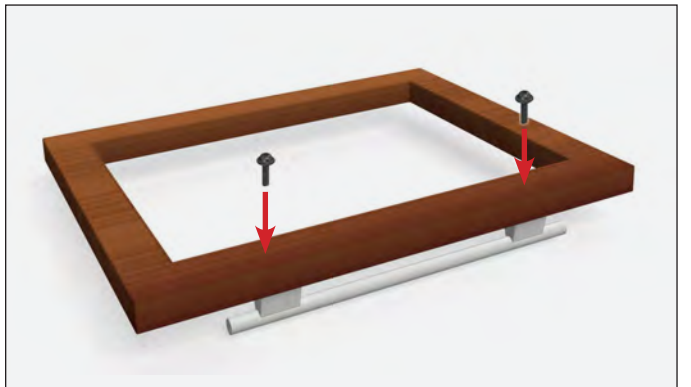

FIG. 7. Install handles before fastening the overlay panel to the door.

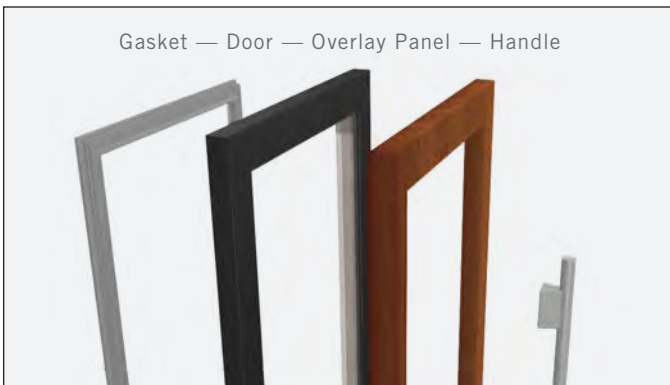

FIG. 8. Door assembly component order.

DRAWER OVERLAY PANEL INSTALLATION

Follow the instructions below to install drawer overlay panels. For custom panel specifications, please see “Custom Panel Specifications” starting on page 25.

NOTE: REMOVE THE DRAWER FRONT AS DESCRIBED FOR EASY OVERLAY PANEL INSTALLATION.

REQUIRED TOOLS

Required tools include (but may not be limited to) the following:

- Surface Protection*
- Phillips Bit Driver
- 1+ Clamp $\geq 2"$ (51 mm)
- 1/8" Drill Bit
- #6 Screws (qty 8)**
- Drill

*Cardboard, moving blanket, foam padding, etc.

**To be supplied by the installer. Screw type and length varies by material. All screws must be 1/2" (13 mm) + Overlay Panel Thickness.

PROCEDURE

1. Carefully lay the drawer overlay panel face down on a protected surface.
2. With a Phillips bit driver, remove the drawer front assembly. See fig. 1.

NOTE: TAKE CARE TO NOT STRIP THE SCREWS.

3. Remove the gasket. See fig. 2.
4. With a 1/8" drill bit, carefully drill the pre-marked pilot holes in the drawer front. See fig. 3.
5. Place the drawer front face down on the overlay panel. Align the drawer front and panel edges. See fig. 4.

6. Clamp the drawer front and panel. See fig. 5.

NOTE: IF THE CLAMP JAWS ARE NOT PADDED, INSERT PADDING BETWEEN THE CLAMP AND THE OVERLAY TO PROTECT THE PANEL'S FINISH.

IF DESIRED, INSTALL A HANDLE BEFORE PROCEEDING TO THE NEXT STEP. FOR BEST INSTALLATION, FASTEN THE HANDLE WITH RECESSED SCREWS. SEE FIGS. 6.

7. Carefully drill pilot holes into the panel. See fig. 7.

NOTE: TAKE CARE TO NOT DRILL THROUGH THE FRONT OF THE PANEL.

8. Fasten the overlay panel to the drawer front. Then, remove the clamp(s).
9. Install the drawer gasket.

NOTE: VERIFY THE GASKET IS FULLY SEATED IN THE GASKET CHANNEL.

10. Install the drawer front assembly. Verify the drawer closes correctly and the gasket seals without gaps.
11. Repeat steps 1-10 for the second drawer.



FIG. 1. Drawer front screw locations. Other side not shown.

PRIOR TO INSTALLATION



FIG. 2. Pull the gasket from the drawer front.

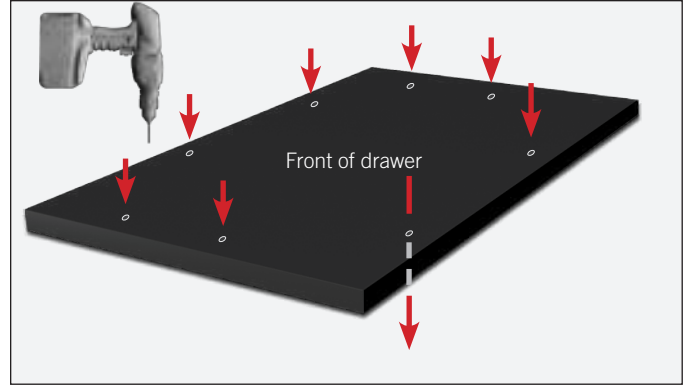

FIG. 3. Drill pilot holes THROUGH the drawer front.

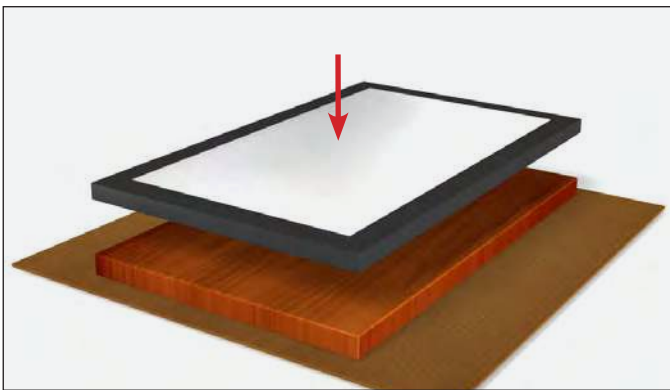

FIG. 4. Be sure the edges are aligned before clamping the drawer front assembly.

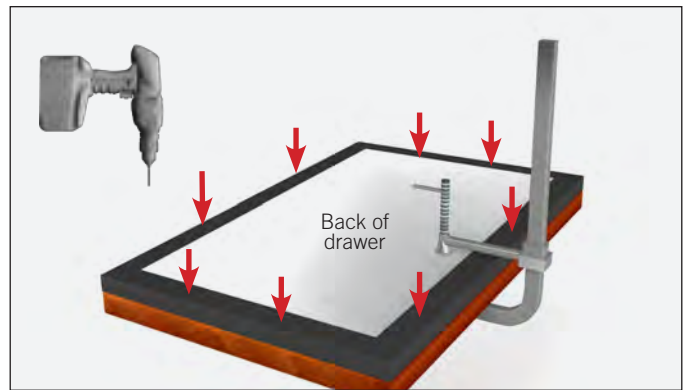

FIG. 5. Be sure NOT to drill through the panel's front.

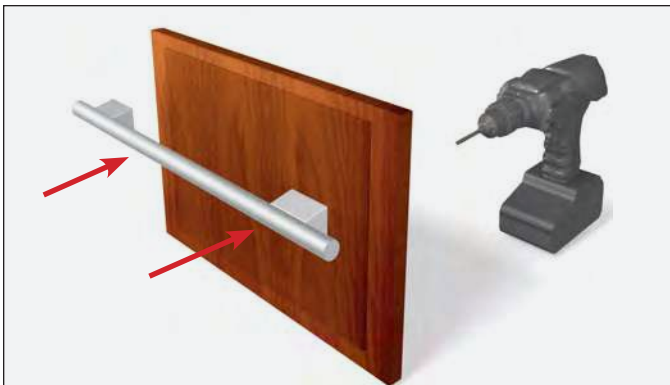

FIG. 6. Install handles before fastening the overlay panel to the door.

WINE RACK HANDLE & OVERLAY PANEL FINISH APPLICATION

See finish (e.g., paint or stain) for application instructions and drying / curing times. Drying / Curing times vary by finish.



NOTE: Finish odors from panels installed before fully drying /curing can linger and be absorbed by the appliance's interior. **True is not responsible for lingering finish odors inside the unit.**

WINE RACK HANDLES

Follow recommended guidelines associated with treating unfinished natural cherry wood.

NOTE: Remove the wine rack handles from the wine rack assembly before applying finish!

REQUIRED TOOLS

Required tools include (but may not be limited to) the following:

- Phillips Screwdriver or Bit Driver
- Drill (optional)

REMOVAL

1. Gently lift the wine rack handle and pull the wine rack forward. See fig. 1.
2. Remove the wine rack handle from the wine rack assembly. See fig. 2.

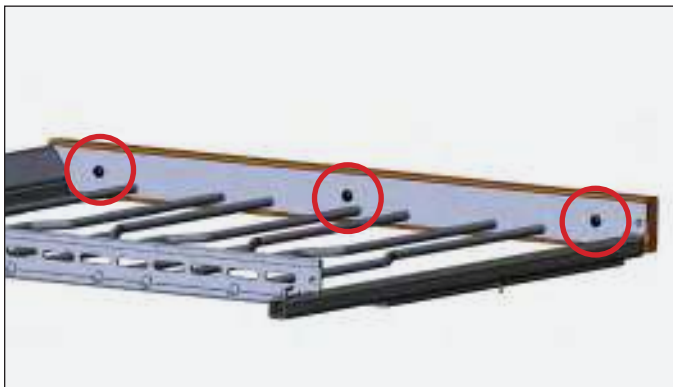

FIG. 2. Wine rack handle screw locations.

INSTALLATION

Finish odors from wine rack handles installed before fully drying /curing can linger and be absorbed by the appliance's interior. **True is not responsible for lingering finish odors inside the unit.**

1. Install the wine rack handle on the wine rack assembly. See fig. 2.
2. Position the wine rack on the slides and carefully push the wine rack towards the back of the unit. See fig. 3.

NOTE: BE SURE THE WINE RACK SITS UNDER THE SLIDES REAR TABS. SEE FIG. 4.



FIG. 1. Lift and pull the wine rack forward.



FIG. 3. Slide the wine rack into place.

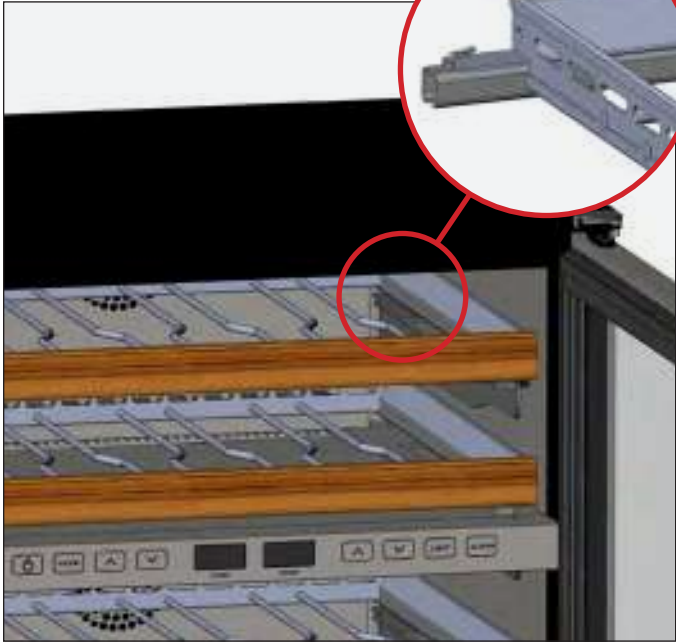

FIG. 4. Be sure the wine rack sits under the rear tabs.

OVERLAY PANELS

See finish (e.g., paint or stain) for application instructions and drying / curing times. Drying / Curing times vary by finish.

For overlay panel installation and removal instructions, please see “Door Overlay Panel Installation” (pg. 30) or “Drawer Overlay Panel Installation” (pg. 32).

TRUE STACKING KIT

24 INCH



15 INCH



24/15 INCH SIDE VIEW



STACKING KIT INSTALLATION

KIT CONTENTS

- (1) Louver Grill (stainless models)
- (2) Stacking Brackets
- (4) 1/4" Hex Head Screws

REQUIRED TOOLS

Required tools include (but may not be limited to) the following:

- Floor protector
- Level
- 1/4" Hex Head Driver
- Drill



RECOMMENDED – This procedure may require assistance.

RECOMMANDÉ – Cette procédure peut nécessiter une assistance.



WARNING – Units may pose a tipping hazard during stacking kit installation or when moving the stacked units.

ATTENTION – Les unités peuvent présenter un risque de basculement lors de l'installation du kit d'empilage ou lors du déplacement des unités empilées.

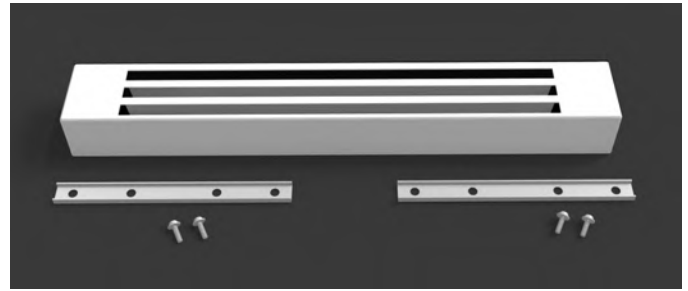

PROCEDURE

1. Position the floor protector near the final installation location.
2. Uncrate the appliances. Secure the shelving, doors, and drawers.
3. Install the anti-tip brackets (see "Anti-Tip Bracket Installation" on pg. 45). Verify the brackets are correctly positioned.
4. Carefully place the upper appliance on the lower appliance.

NOTE: DO NOT LIFT THE CABINET BY THE COUNTERTOPS, DOORS, DRAWERS, OR GRILLS. THIS STEP MAY REQUIRE ASSISTANCE.

5. Level the upper appliance.
6. Align the upper appliance with the lower appliance's sides and back.
7. Install the rear stacking brackets. See fig. 1.
8. Position the stacked units in the final installation location.
9. Verify the level of both appliance's. Adjust the leveling legs as needed. See fig. 2.
10. Remove the upper appliance's kickplate. See fig. 3.
11. Install the louver grill. See figs 4-6.

NOTE: Be sure to consider air flow when adding a panel to the grill or door.

STACKING KIT INSTALLATION (CONT.)

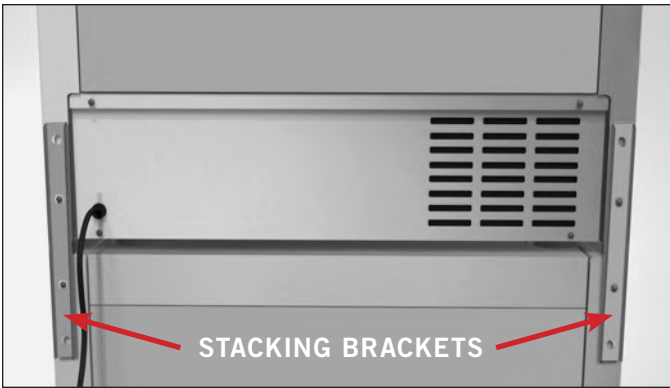

FIG. 1. The rear stacking brackets.



FIG. 2. Verify the level front-to-back and side-to-side.

STACKING KIT INSTALLATION



FIG. 3. Remove the kickplate.



FIG. 4. Position the provided grill.

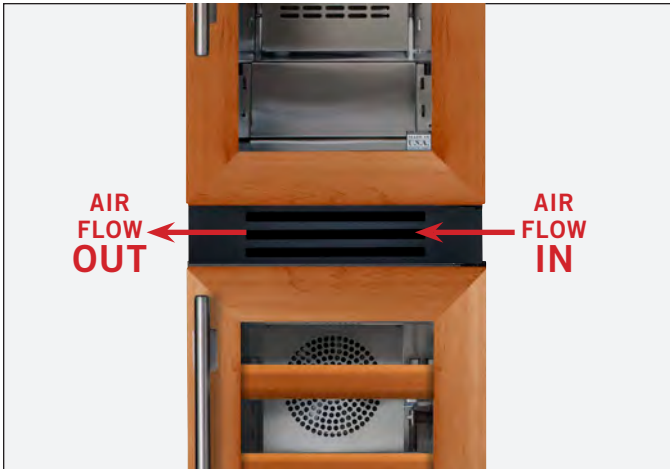

FIG. 5. Airflow direction.



FIG. 6. Approximate distance from the bottom of the top door to the top of the bottom appliance.

ELECTRICAL INSTALLATION & SAFETY

The unit is approved by UL for outdoor installation.

USE OF ADAPTER PLUGS

NEVER USE AN ADAPTER PLUG!

An adapter plug alters the OEM plug configuration when connecting it to a power source.



TRUE will not warranty any refrigerator/ freezer that has been connected to an adapter plug.

USE OF EXTENSION CORDS

NEVER USE AN EXTENSION CORD!

An extension cord is determined to be any component that adds length to the OEM power cord when connecting it to a power source.



TRUE will not warranty any refrigerator/ freezer that has been connected to an extension cord.

- The appliance should always be plugged into a dedicated electrical circuit. This provides the best performance and prevents building wiring circuits from being overloaded, which could cause a fire hazard from overheated wires.
- Before your new unit is connected to a power supply, check the incoming voltage with a voltmeter. If the recorded voltage is less than the rated voltage for operation (+/-5%) and amp rating, correct immediately. Refer to appliance serial label for this voltage requirement.
- The electrical outlet must be within 36" (914.4 mm) of the center of the back wall of the appliance's final location. Outlet must be flush with wall and comply with local electrical codes.

PRIOR TO INSTALLATION

- The wall outlet and circuit should be checked by a licensed electrician to make sure the outlet is properly grounded.
- The power cord of this appliance is equipped with a 3-prong (grounding) plug which mates with a standard 3-prong (grounding) wall outlet to minimize the possibility of electric shock hazard from this appliance. A 115V AC, 60 Hz, 15 amp circuit breaker and electrical supply are required.
- If the outlet is a standard 2-prong outlet, it is your personal responsibility and obligation to have it replaced with the properly grounded wall outlet.
- **DO NOT**, under any circumstances, cut or remove the ground prong from the power cord. For personal safety, this appliance must be properly grounded.
- When moving the appliance, for any reason, be careful not to roll over or damage the power cord.
- Repair or replace immediately all power cords that have become frayed or otherwise damaged. **DO NOT** use a power cord that shows cracks or abrasion damage along its length or at either end.
- If the supply power cord is damaged, it should be replaced with original equipment manufacturer (OEM) components. To avoid hazard this should be done by a licensed service provider.
- **NEVER** unplug your appliance by pulling on the power cord. Always grip plug firmly and pull straight out from the outlet.

ELECTRICAL INSTALLATION & SAFETY (CONT.)

ELECTRICAL OUTLET LOCATION

To minimize the depth of the cutout opening, the electrical outlet must be positioned as shown. Outlet must be flush with wall.

NOTE: TRUE IS NOT RESPONSIBLE FOR THE REPAIR OR REPLACEMENT OF FAILED OR DAMAGED COMPONENTS RESULTING FROM ELECTRICAL POWER FAILURE, HIGH OR LOW VOLTAGE, USE OF EXTENSION CORDS, OR IMPROPER GROUNDING OF THE UNIT.

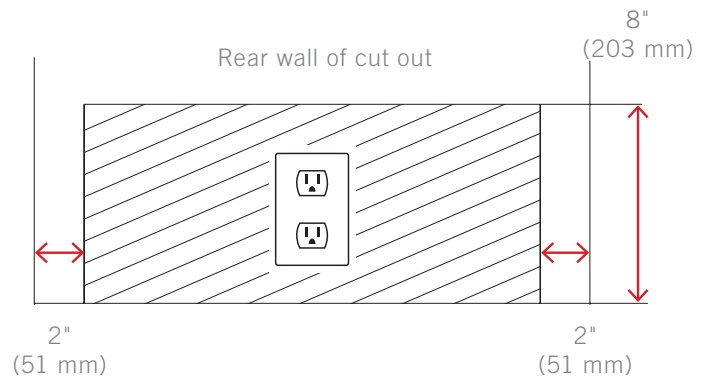

INSTALLATION

UNCRATING

ANTI-TIP BRACKET INSTALLATION

LEVELING

120° DOORSTOP INSTALLATION

KICKPLATE INSTALLATION

90° HINGE INSTALLATION (OPTIONAL)



PRESERVE THE MOMENT®

UNCRATING

NOTE: KEYS FOR THIS UNIT ARE LOCATED ON THE BACK COVER OF THIS MANUAL. THE ANTI-TIP BRACKET KIT AND THE DOORSTOP (FOR STAINLESS STEEL UNITS) ARE PACKAGED WITH THE KICKPLATE.

NOTE: IF THE APPLIANCE IS DAMAGED, NOTE ALL DAMAGE ON THE DELIVERY RECEIPT, IMMEDIATELY FILE A CLAIM WITH THE DELIVERY FREIGHT CARRIER, AND CONTACT TRUE. DO NOT INSTALL THE APPLIANCE OR PUT IT IN SERVICE.

REQUIRED TOOLS

Required tools include (but may not be limited to) the following:

- Cutting tool
- Hammer
- Floor Protection

PROCEDURE

1. Inspect the exterior packaging for damage. Immediately file a claim with the freight carrier if there is damage.
2. Remove the exterior packaging.

NOTE: DO NOT DISCARD THE KICKPLATE. SEE FIG. 1.

3. Inspect the appliance (exterior and interior) for concealed damage. Immediately file a claim with the freight carrier if there is damage.
4. Move the unit as close as possible to the final installation location.
5. Remove the outer shipping tape and foam door shipping blocks.
6. Remove a side runner board from the skid. See fig. 2.
7. Position floor protection next to the skid.

8. Carefully work the unit off the skid's side and onto the floor protection. See fig. 3.

NOTE: DO NOT MOVE THE UNIT BY DOORS, HANDLES, DRAWER FRONTS, OR HINGES.

NOTE: DO NOT REMOVE THE INTERIOR PACKAGING UNTIL THE UNIT IS POSITIONED IN THE FINAL INSTALLATION LOCATION.

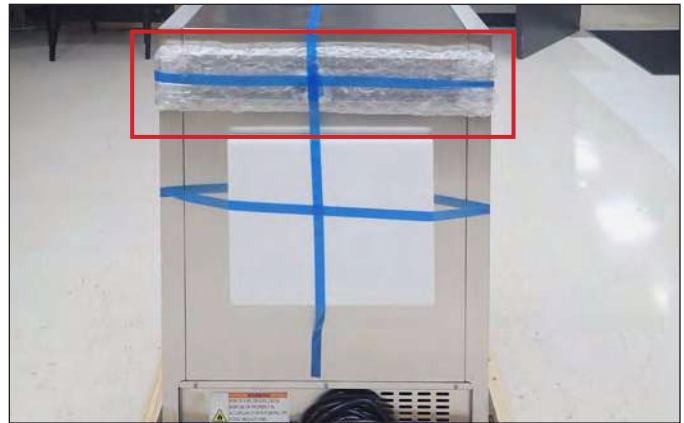

FIG. 1. The kickplate ships taped to the unit's back.



FIG. 2. Pry the side runner board off the skid.



FIG. 3. Get the unit off the skid from the side.

ANTI-TIP BRACKET INSTALLATION

IMPORTANT!

ALL FREE STANDING DRAWER OR STACKED UNITS MUST HAVE ANTI-TIP BRACKETS INSTALLED.

KIT CONTENTS

- 2 – Anti-Tip Brackets
- 4 – 3/16" x 2-1/4" Concrete Screws
- 4 – 12 x 2" Phillips Wood Screws

REQUIRED TOOLS

- Floor Protector
- Tape Measure
- Marking Utensil
- 1/8" Drill Bit*
- Phillips Bit Driver or 1/4" Hex-Head Driver
- Drill

*Drill bit type will vary by flooring material.



CAUTION – ALL UNITS OR STACKED UNITS MUST HAVE ANTI-TIP BRACKETS INSTALLED.

Install the anti-tip brackets before moving the unit into its final operating position. Contact a qualified flooring installer for the best procedure of drilling mounting holes through your flooring material.

PROCEDURE

1. Determine the final installation location of the unit.
2. Measure 27/32" (22 mm) inset from the sides and either 27/32" from the back or 18-1/2" (470 mm) from the front (measure does not include the kickplate). See figs. 1 & 2.
3. Position the anti-tip brackets and mark the mounting hole locations.
4. With a 1/8" drill bit, drill pilot holes at the marked locations.

NOTE: BE SURE TO USE A DRILL BIT APPROPRIATE FOR YOUR FLOORING MATERIAL.

5. With the appropriate provided hardware, install the anti-tip brackets. See fig. 3.

NOTE: THE CONCRETE SCREWS ARE BLUE.

6. Carefully position the unit in its final installation location. Be sure the rear leveling legs slide into the anti-tip brackets. See fig. 4.

NOTE: DO NOT LIFT THE APPLIANCE BY THE COUNTERTOPS, DOORS, DRAWERS, OR GRILLS.

ANTI-TIP BRACKET INSTALLATION (CONT.)

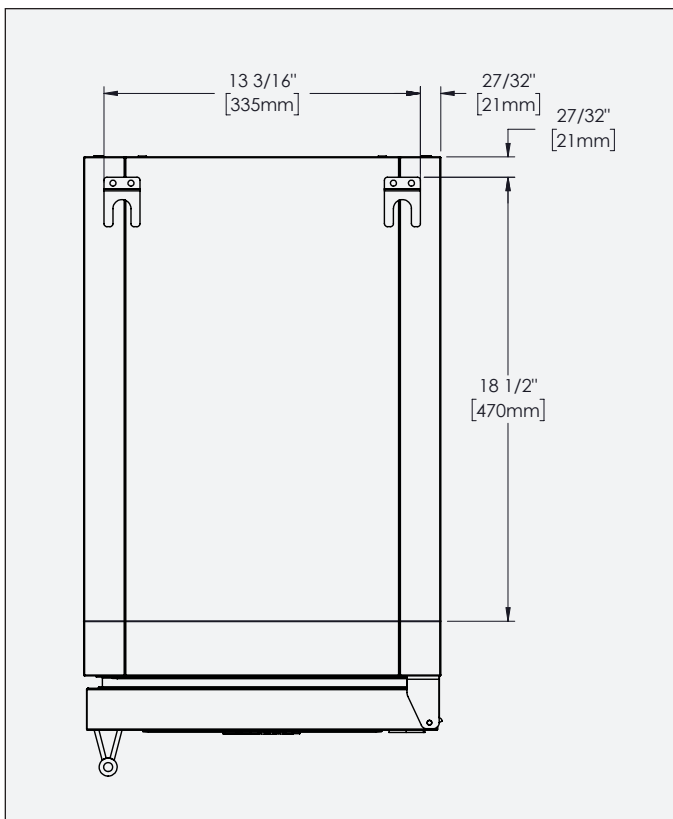

FIG. 1. 15" model top down plan view of anti-tip bracket location.

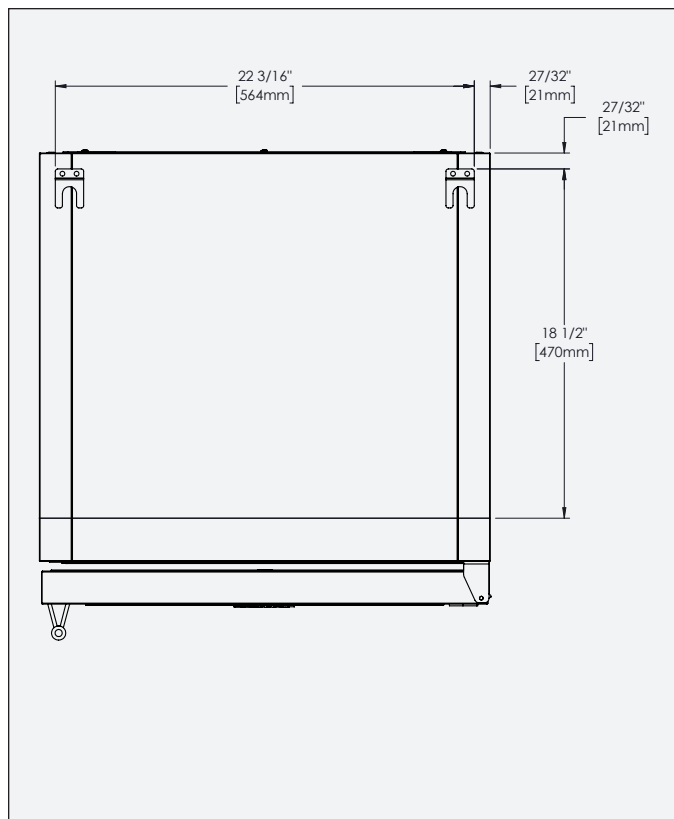

FIG. 2. 24" model top down plan view of anti-tip bracket location.



FIG. 3. Securely fasten the anti-tip brackets to the floor.

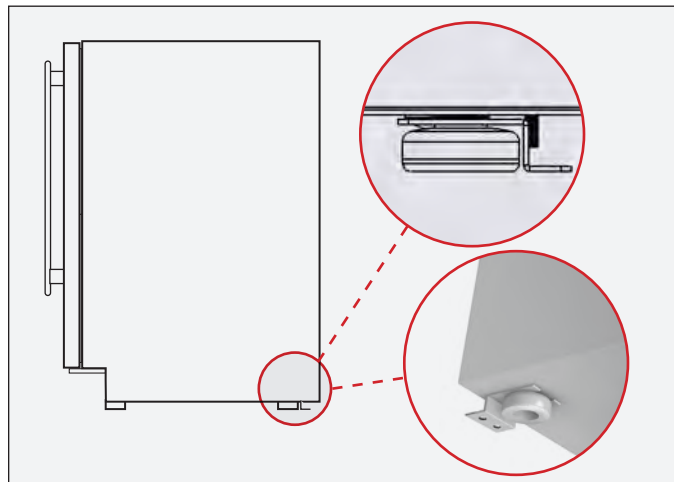

FIG. 4. Be sure the rear leveling legs slide into the brackets.

LEVELING

Proper leveling of your TRUE unit is critical to operating success. Leveling impacts effective condensate removal and door operation.

With the appliance in the final installation location, level the unit front-to-back and side-to-side.

PROCEDURE

1. Position the level on the inside floor of the unit near the doors (the level should be parallel to appliance front). Level the appliance.
2. Position the level at the inside rear of the appliance (again, the level should be placed parallel to appliance back). Level the appliance.
3. Perform procedures similar to steps 1 and 2 by placing the level on the inside floor (left and right side, parallel to the depth of the appliance). Level the appliance.

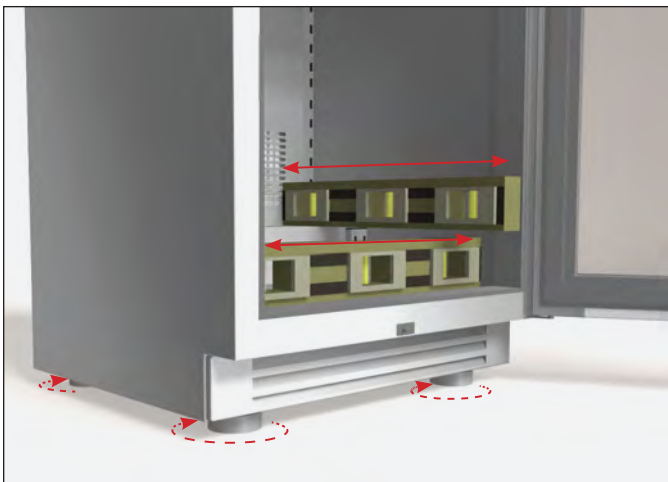

120° DOORSTOP INSTALLATION

All units ship with an optional doorstop. The doorstop restricts the door from opening past approximately 120° to prevent damage to surrounding cabinetry.

REQUIRED TOOLS

Required tools include (but may not be limited to) the following:

- Phillips Screwdriver

PROCEDURE

Install the doorstop on the door's bottom edge. See figs. 1 and 2.

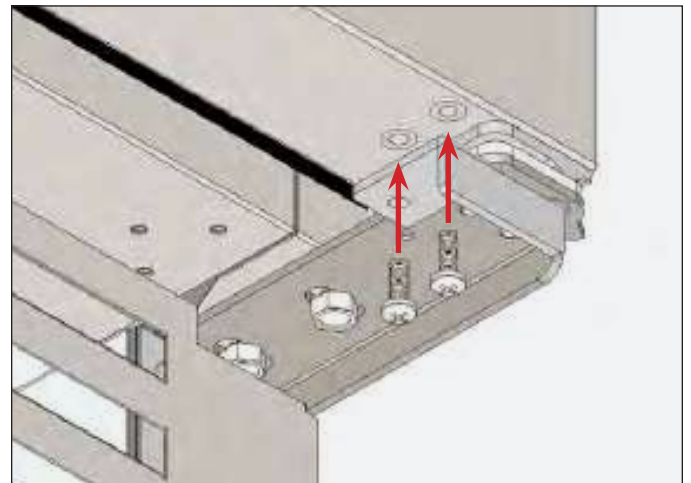

FIG. 1. Install the doorstop bracket next to the hinge.

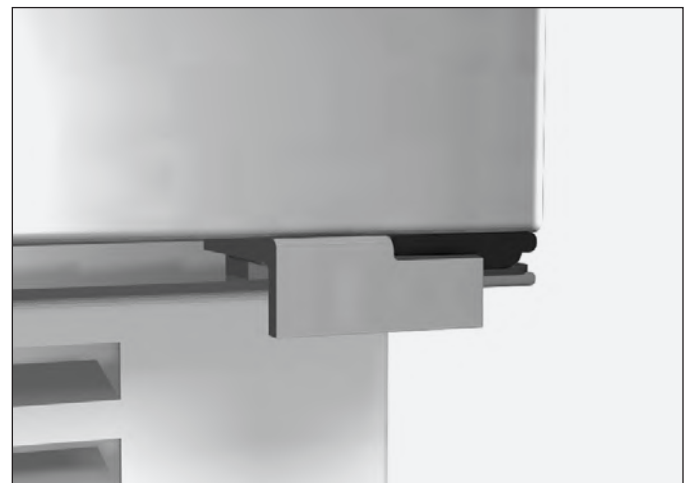

FIG. 2. Installed doorstop.

INSTALLATION

KICKPLATE INSTALLATION

The kickplate is shipped uninstalled to the unit to allow easy access for leveling. The kickplate attaches to the unit with magnets at the bottom of the unit.

INSTALLATION

1. After leveling the unit, locate the kickplate taped to the back of the unit. See fig. 1.
2. Position the kickplate below the door. See fig. 2.
3. Verify the kickplate is correctly aligned. Adjust as needed.

REMOVAL

Pull the kickplate away from the unit.

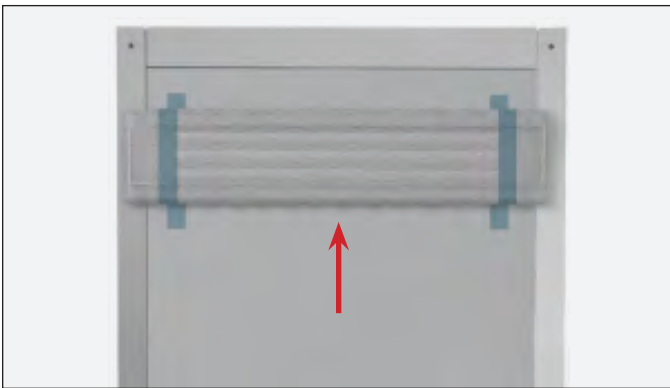

FIG. 1. The kickplate ships taped to the unit's back.



FIG. 2. Attach the kickplate to the magnets below the door.

90° HINGE INSTALLATION (OPTIONAL; STAINLESS STEEL ONLY)

KIT CONTENTS

- 90° Hinge (left or right)
- Doorstop Bracket (left or right)

REQUIRED TOOLS

Required tools include (but may not be limited to) the following:

- 3/8" Socket wrench
- Phillips Screwdriver

PROCEDURE

1. Remove the kickplate. See fig. 1.
2. Remove the existing bottom door hinge. See fig. 2.

NOTE: BE SURE TO SUPPORT THE DOOR WHILE REMOVING THE HINGE.

3. Carefully slide the door from the top hinge. See fig. 3.
4. Install the doorstop bracket on the door's bottom edge. See fig. 4.
5. Position the door and install the 90° hinge. See fig. 5.

NOTE: DO NOT COMPLETELY TIGHTEN THE BOLTS.

6. Verify the door is aligned with the lock latch and light switch. See fig. 6. Verify the door closes correctly and the gasket seals without gaps. Adjust the door as needed.
7. Tighten the hinge bolts.

INSTALLATION

90° HINGE INSTALLATION (OPTIONAL; STAINLESS STEEL ONLY) (CONT.)

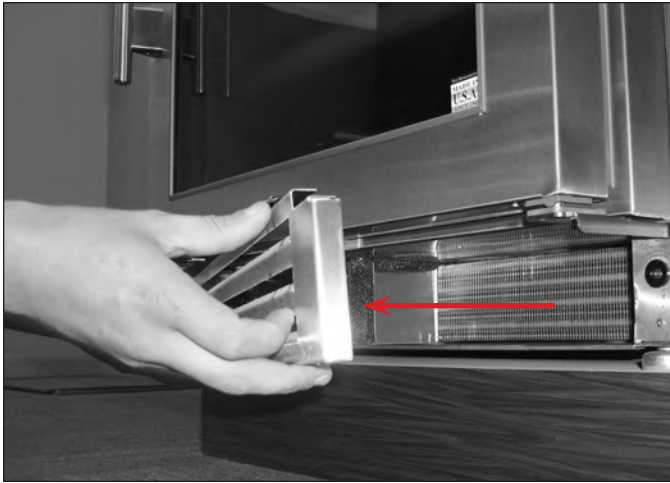

FIG. 1. Pull the kickplate off the magnets.

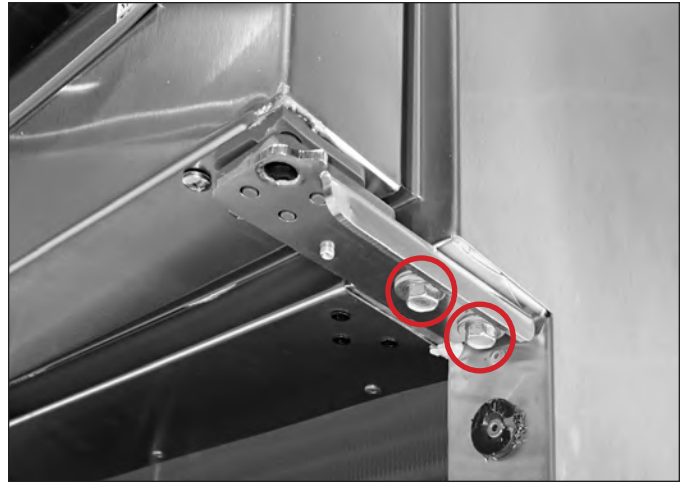

FIG. 2. Bottom hinge bolt locations.



FIG. 3. Lower the door off the top hinge.



FIG. 4. Doorstop bracket installed on door.



FIG. 5. Installed 90° hinge kit.



FIG. 6. Lock latch and light switch locations.

GLASS SHELF ADJUSTMENT

WINE RACK ADJUSTMENT

DRAFT STANDARD INSTALL & HOOK UP

DRAFT STANDARD INSTALL (COUNTERTOP)

DRIP TRAY INSTALLATION

DISPENSING PRESSURE

TAPPING

CHANGING CO₂ GAS CYLINDER

CO₂ REGULATOR PRESSURE ADJUSTMENT

DRAFT TOWER CLEANING



PRESERVE THE MOMENT®

GLASS SHELF ADJUSTMENT

The mounting brackets / glide assemblies ship installed on the glide out glass shelves.

INSTALLATION

Hook the mounting brackets / glide assemblies into the pilasters. See fig. 1.

REMOVAL

Carefully lift the shelf assembly up. Then, pull the shelf assembly forward. See fig. 1.

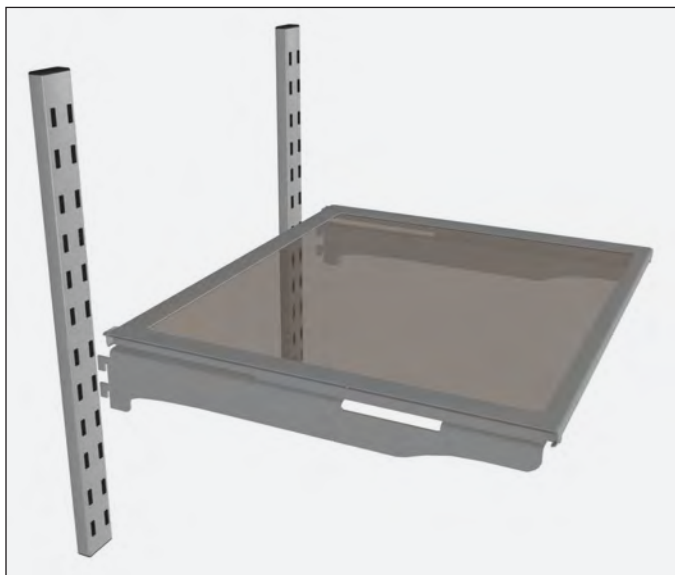

FIG. 1. Slide the mounting bracket tabs into the pilaster.

WINE RACK ADJUSTMENT

Wine racks in TBC, TWC, and TWZ-DZ consist of two mounting bracket / glide assemblies and the wire wine rack.

REMOVAL

1. Gently lift the wine rack handle and pull the wine rack forward. See fig. 1.
2. Lift the mounting brackets and pull the brackets forward.
3. Repeat steps 1 and 2 as needed.

INSTALLATION

1. Hook the mounting bracket with the anti-vibration bumpers (see fig. 2) into the hinge-side pilaster.
2. Hook the remaining mounting bracket into the other pilaster.
3. Position the wine rack on the slides and carefully push the wine rack towards the back of the unit. See fig. 3.

NOTE: BE SURE THE WINE RACK SITS UNDER THE SLIDES' REAR TABS. SEE FIG. 4.

4. Repeat steps 1-3 as needed.

CORRECT FIT

The glide's front tab must fit securely in the gap between the handle and the rack. See fig. 5. If the fit is too tight, loosen the screws on the back of the handle to increase the gap.

The wine shelves are held securely by the anti-vibration bumpers. If there is too much play side-to-side, tighten the bumpers against the compartment walls by rotating them with your fingers.

APPLIANCE SETUP

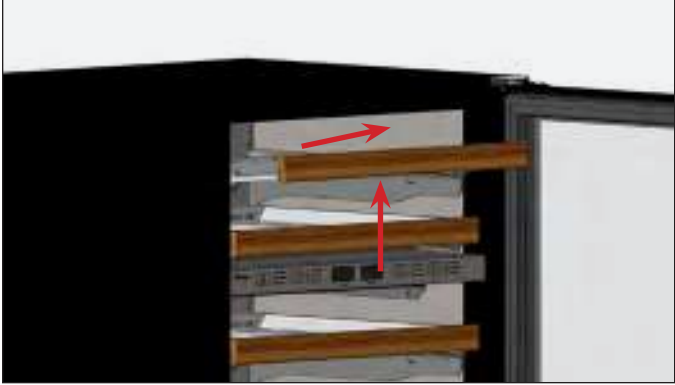

FIG. 1. Lift and pull the wine rack forward.



FIG. 2. Be sure the anti-vibration bumpers are on the hinged side.



FIG. 3. Slide the wine rack into place.



FIG. 4. Be sure the wine rack sits under the rear tabs.

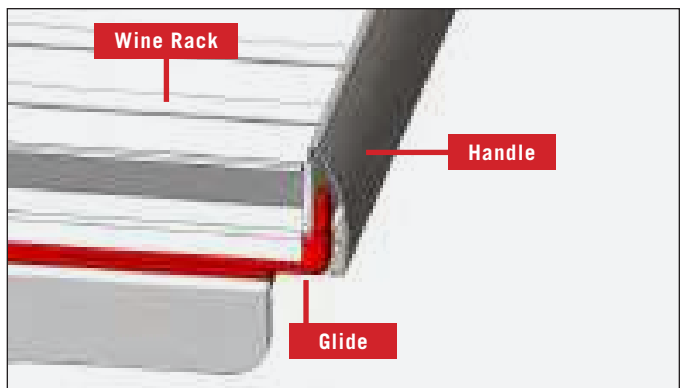

FIG. 5. The glide's front tab goes in the gap between the handle and rack.

DRAFT STANDARD INSTALLATION & HOOK UP

REQUIRED TOOLS

- Phillips Screwdriver
- Adjustable Wrench

KIT CONTENTS

- A. CO₂ Tank (Shipped empty. Fill before use)
- B. Draft Standard*
- C. Draft Standard Screws
- D. Draft Standard Handles*
- E. CO₂ Pressure Regulator (single version/double version)
- F. Chill Hose**
- G. Rubber Washer
- H. CO₂ Hoses*
- I. Hose Clamps
- J. Safety strap
- K. Beer Tapper (Sankey, low profile tapper)
- L. PVC pipe (not shown)

*Double draft standard kit shown.
 **Located inside the appliance.



WARNING! – CONTENTS UNDER PRESSURE. TAKE CARE WHEN HANDLING FILLED CO₂ TANKS. IF UNFAMILIAR WITH USING CO₂ TANKS AND/OR REGULATORS, SEEK INFORMATION FROM YOUR LOCAL DISTRIBUTOR OR BREWER REPRESENTATIVE BEFORE PROCEEDING.



PROCEDURE

1. Position the rubber gasket over the mounting holes in the appliance countertop. See fig. 1.
2. Run the beer line(s) through the hole and into the appliance. See fig. 2.
3. With the provided hardware, install the draft standard. See fig. 3.
4. Install the draft standard handle(s). See fig. 4.
5. Remove the draft standard top. See fig. 5.



FIG. 1. Position the rubber gasket around the draft tower hole.

DRAFT STANDARD INSTALL & HOOK UP (CONT.)

- Hook the chill hose's clip to the top of the draft standard insulation sleeve. See fig. 6.

NOTE: DO NOT REMOVE THE INSULATION SLEEVE FROM THE DRAFT STANDARD.

- Reinstall the draft standard top.
- Attach the pressure regulator to the CO₂ cylinder. See fig. 7.

NOTE: FILL THE CO₂ CYLINDER BEFORE INSTALLATION. DO NOT LAY CO₂ CYLINDERS ON THEIR SIDE. DO NOT DROP CO₂ CYLINDERS.

- With the hose clamp(s), connect the provided clear vinyl hose(s) to the pressure regulator. See fig. 7.
- Install the safety strap inside the appliance. See fig. 8.
- Position the CO₂ cylinder inside the appliance. Then, fasten the safety strap around the cylinder. See fig. 9.

- Attach the taper to the keg. See fig. 10.
- With the hose clamp(s), connect the provided clear vinyl hose(s) to the taper's air inlet.

NOTE: MAKE SURE CLAMP IS ON THE HOSE PRIOR TO ATTACHING.

- Pressurize the system and check the connection points for leaks. If the system leaks, verify all fittings and clamps are tight and seal correctly.
- With the hose clamp(s), connect the draft standard line(s) to the taper.

NOTE: MAKE SURE CLAMP IS ON THE HOSE PRIOR TO ATTACHING.

- Engage the taper. See fig. 11.
- Position the keg inside the appliance.



FIG. 2. Thread the draft standard lines into the appliance.



FIG. 3. Secure the draft standard to the countertop.



FIG. 4. Screw the handles on.



FIG. 5. Lift the top off the draft standard.



FIG. 6. Route the chill hose into the draft standard from below (A) and hook it on the top of the insulation sleeve (B).

DRAFT STANDARD INSTALL & HOOK UP (CONT.)



FIG. 7. Installed pressure regulator and air hoses. Be sure the hose clamps are tightened to prevent leaks.

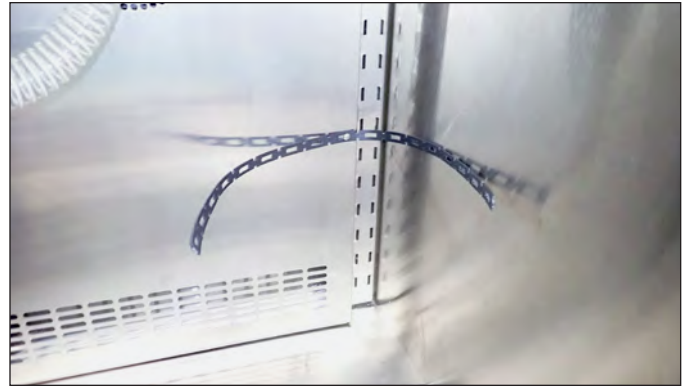

FIG. 8. Installed safety strap.



FIG. 9. Always strap the CO₂ cylinder into the appliance.



FIG. 10. Installed and connected tapper. Be sure the hose clamps are tightened to prevent links.



Push the tapper down and rotate the tapper clockwise.

FIG. 11. Engaged tapper vs. disengaged tapper



Rotate the tapper counterclockwise.

DRAFT STANDARD INSTALL (COUNTERTOP)

USE THE FOLLOWING PROCEDURE IF INSTALLING THE DRAFT STANDARD DIRECTLY ONTO A COUNTERTOP. SEE FIG. 1.

KIT CONTENTS

- 6" (152.4mm) PVC*
- Coupling*

*Provided by TRUE

REQUIRED TOOLS

- 2-1/2" Hole Saw**
- Drill bit appropriate for #10 screw**
- (4) #10 mounting screws (oval head or countersunk)**
- Bit Driver
- Drill
- Food Grade Silicone
- Anchors (possible)**

**Appropriate for the countertop material and thickness. To be supplied by the installer.

PROCEDURE

NOTE: DISREGARD THE RIVNUTS IN THE APPLIANCE TOP. THE DRAFT TOWER FASTENS DIRECTLY TO THE COUNTERTOP.

1. Determine and mark draft standard and draft standard mounting hole locations. See figs. 2 and 3.

NOTE: FOR CORRECT INSTALLATION, COUNTERTOP AND UNIT DRAFT STANDARD HOLES MUST ALIGN.

2. With a hole saw, carefully drill draft standard hole through the countertop.

NOTE: BE SURE THE HOLE SAW IS APPROPRIATE FOR THE COUNTERTOP MATERIAL.



FIG. 1. Example of countertop draft standard installation.

3. With a drill bit, carefully drill draft standard mounting holes in the countertop.

NOTE: BE SURE THE DRILL BIT IS APPROPRIATE FOR THE COUNTERTOP MATERIAL.

4. Align the unit with the drilled hole. See fig. 4.
5. Install the provided coupling and PVC tubing in the draft standard holes. See fig. 5.

NOTE: DO NOT USE PVC GLUE.

6. Cut the coupling and PVC tubing flush with the countertop.

DRAFT STANDARD INSTALL (COUNTERTOP)(CONT.)

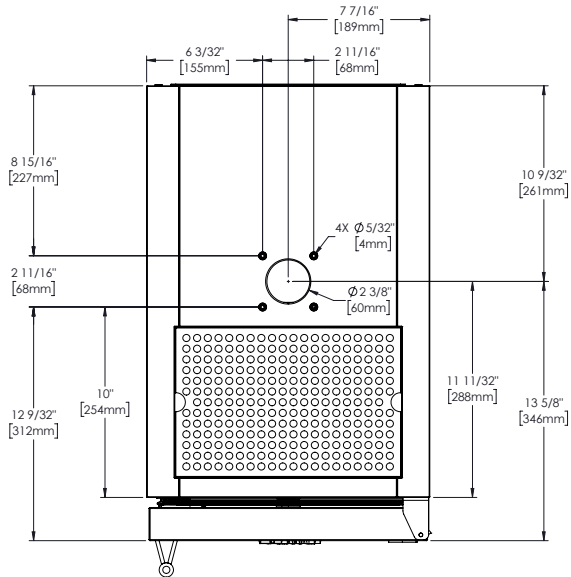

FIG. 2. 15" Model Specifications (top view).

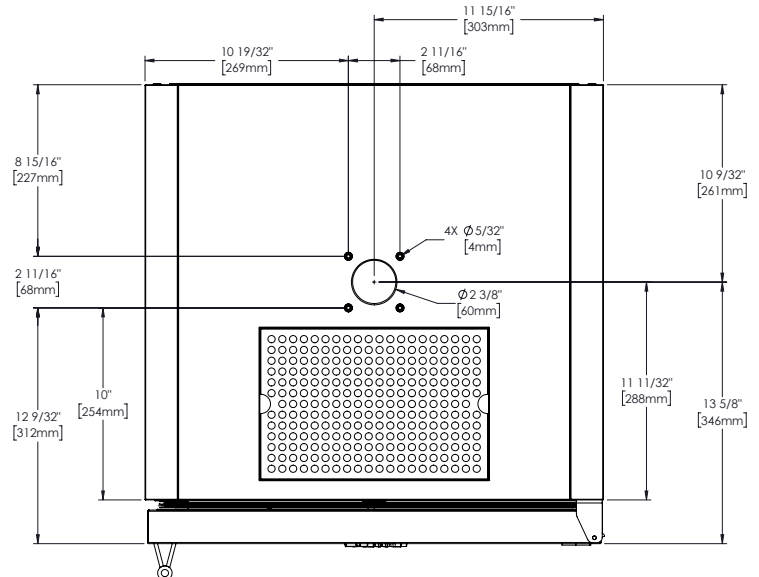

FIG. 3. 24" Model Specifications (Top View)

PROCEDURE (CONT.)

- Apply food grade silicone to any gaps between the PVC tubing and the countertop.

NOTE: CLEAN EXCESS SILICONE.

- Proceed to "Draft Standard Installation & Hook Up." Be sure to use draft standard mounting screws appropriate for countertop material and thickness.

NOTE: DISREGARD THE RIVNUTS IN THE APPLIANCE TOP. THE DRAFT TOWER FASTENS DIRECTLY TO THE COUNTERTOP. USE INSTALLER-SUPPLIED ANCHORS FOR THE DRAFT TOWER MOUNTING SCREWS IF NEEDED.



FIG. 4. Align the holes in the appliance with the drilled hole.

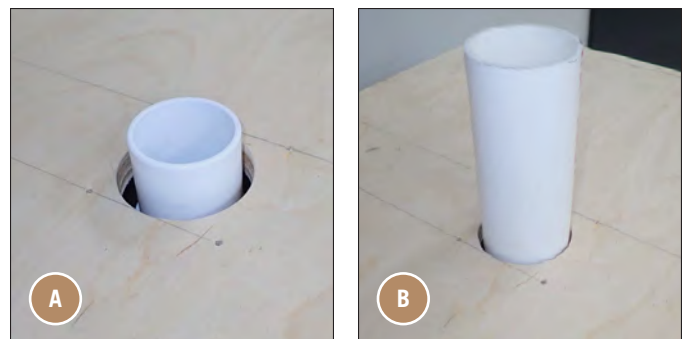
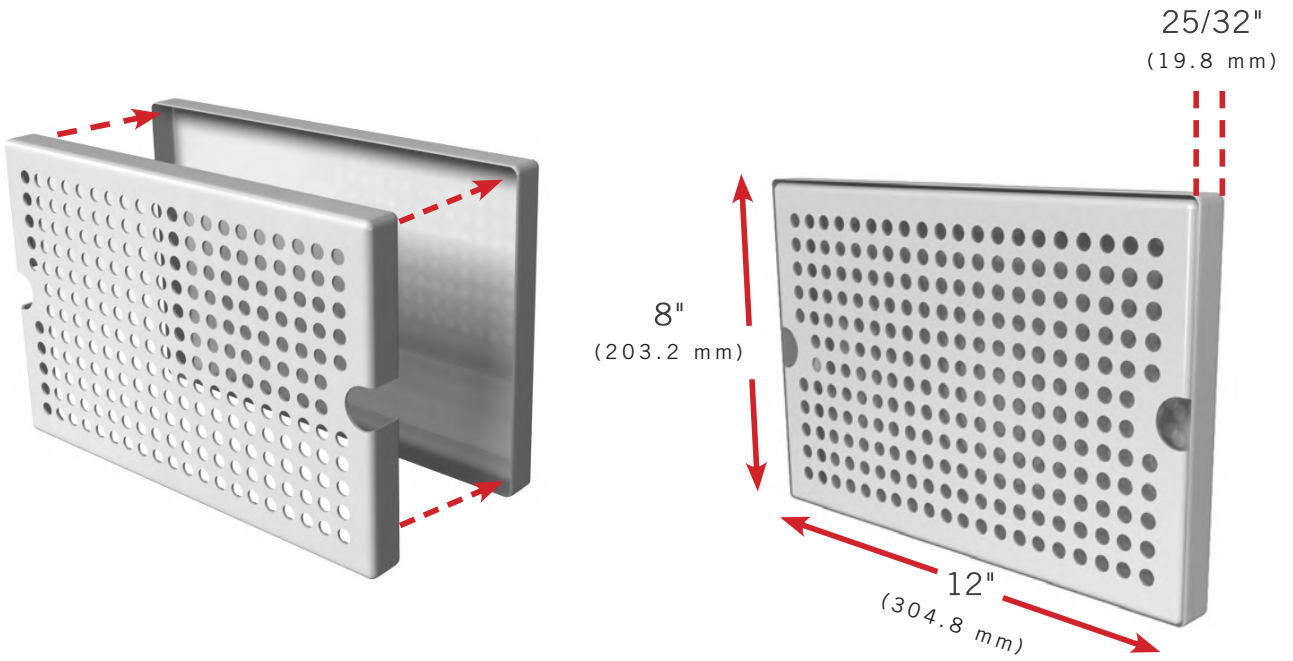

FIG. 5. Cut the coupling (A) and the PVC tubing (B) flush with the countertop.

DRIP TRAY INSTALLATION

Assemble the drip tray and place it beneath the draft tower spout(s).



DISPENSING PRESSURE

DISPENSING PRESSURES DIFFER ACCORDING TO:

- The type of draft dispensing system
- The length of draft dispensing line
- The actual product – some require more, some require less
- The temperature of the product
- The pressurizing agent: Air pressure, CO₂ or special blended gases

HELPFUL HINTS ON MAINTAINING THE CORRECT PRESSURE

- Know which pressurizing agent to use on which product and why
- Monitor your regulators to ensure applied pressure remains constant
- Keep equipment in good repair

TAPPING

Do not agitate the kegs unnecessarily. If excessive agitation occurs allow kegs to settle for 1 to 2 hours before tapping. Prior to tapping the keg, ensure that all beer faucets in the serving location are in the off position. Completely remove the dust cover (identification cap) from the keg.

CHANGING CO₂ GAS CYLINDER

CAUTION: ALWAYS FOLLOW THESE INSTRUCTIONS WHEN YOU REPLACE A CO₂ GAS CYLINDER:

1. Close cylinder valve **A**.
2. Remove tap head **D** from the barrel. Pull the pressure release ring on body of the tap to release pressure remaining in line. (**DO NOT** close regulator shutoff **C**).
3. Remove or loosen regulator key **B** by turning counter clockwise.
4. Remove the regulator from used cylinder at **E**.
5. Remove the dust cap from new gas cylinder at outlet **E** and clear dust from the outlet by opening and closing valve **A** quickly using appropriate wrench.
6. Attach the regulator to the new cylinder at outlet **E**. (use new fiber/plastic washer, if required).
7. Completely open valve **A**.
8. Close valve **C**.
9. Adjust the regulator key **B** by turning clockwise to set pressure. Check setting by opening **C** and pulling and releasing the ring **F** on the pressure release valve on the body of the tap).
10. Tap the barrel at **D** with valve **C** open.

NOTE: DON'T LAY CO₂ CYLINDERS FLAT. DON'T DROP CO₂ CYLINDERS.

IT REQUIRES 1/2 POUND (0.23 KG) OF CO₂ TO DISPENSE 1/2 BARREL OF BEER AT 38°F (3.3°C) WITH 15 PSI (1.03 BAR) OF PRESSURE ON THE BARREL.

CO₂ REGULATOR PRESSURE ADJUSTMENT

Increasing Pressure

1. Close regulator shut-off **C**.
2. Turn the regulator key **B** clockwise and adjust setting.
3. Tap the gauge for an accurate reading.
4. Open regulator shut-off **C** and draw beer.



WARNING: Contents under pressure. Take care when handling filled CO₂ tanks. If unfamiliar with using CO₂ tanks and/or regulators, seek information from your local distributor or brewer representative before proceeding.

Decreasing Pressure

1. Close regulator shut-off **C**.
2. Untap the barrel at **D** and to bleed line, activate the tap handle. Leave it in the open position.
3. Slowly open regulator shut-off **C** and simultaneously turn regulator key **B** counter-clockwise to zero reading.
4. Close regulator shut-off **C** and set pressure by turning regulator key **B** clockwise. Check the setting by opening and closing valve **C**.
5. Close the tap head **D**. (Put in **OFF** position).
6. Tap the barrel at **D** and open regulator shut-off **C**.

15 INCH

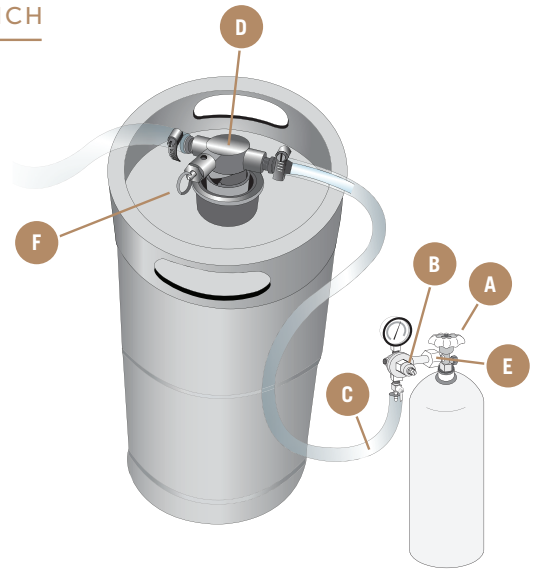

24 INCH

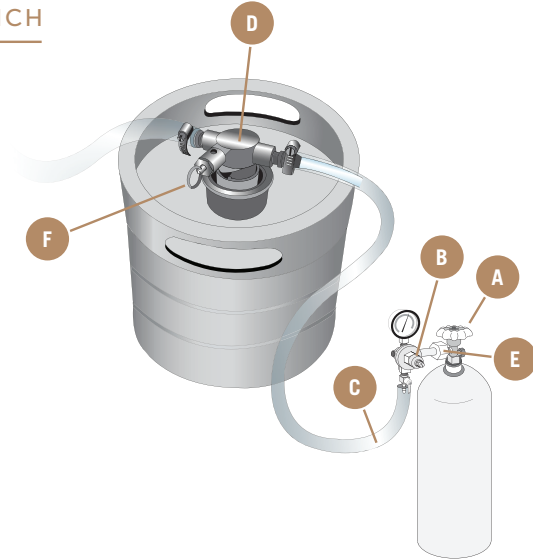

PARTS KEY

A	Cylinder Valve
B	Regulator Key
C	Regulator Shut-off
D	Tap Head
E	CO2 Cylinder Outlet
F	Ring

DRAFT TOWER CLEANING

Regardless of design, draft dispensers must be cleaned regularly. Flushing the draft dispenser with only water is not enough to maintain cleanliness. True recommends cleaning the draft dispenser whenever changing to a fresh keg.

Clean dispensers ensure your draft beer will be at its best when served. Although the beer in the barrel is in excellent condition, the beer can become less satisfying if drawn through a dirty beer line and faucet.

NOTE: USE CLEANERS APPROVED BY YOUR BEER SUPPLIER AND FOLLOW THEIR INSTRUCTIONS. IF YOU ARE USING THE CLEANING KIT PURCHASED FROM TRUE FOLLOW THE INSTRUCTIONS BELOW.

Cleaning kit available at store.trueresidential.com/collections/maintenance-1/products/beer-line-cleaning-kit

Cleaning solution available at store.trueresidential.com/collections/maintenance-1/products/beer-line-cleaning-solution

PREPARE SOLUTION

Add 1/2 ounce (14 ml) of cleaning solution to each quart of warm water. Fill pump bottle with the mixed cleaning solution.

BEER CLEANING INSTRUCTIONS

1. Shut-off the CO₂ at the regulator.
2. Remove the tapping device (keg coupler) from the keg.
3. Unscrew handle from faucet.
4. Remove beer faucet with spanner wrench (turn clockwise to remove). See image 1.
5. Put tap and faucet parts in a bucket.
6. Thread hose from pump bottle to beer column tap outlet (be sure rubber gasket is in place to prevent leakage) – allow beer line to drain in bucket. See Image 2.
7. Pump solution from bottle through the beer line(s) into the bucket. Wait 10 minutes while cleaning solution works through the lines.
8. Use supplied brush to clean beer faucet parts. See Image 3.
9. Rinse parts thoroughly.
10. Rinse bucket, pump bottle and hose thoroughly with clean cool water.
11. Fill pump bottle with clean cool water and pump through lines until water runs clear. (repeat if necessary)
12. When crystal clear water comes through, you're ready to assemble and reattach faucet and re-tap the keg.

DRAFT TOWER CLEANING (CONT.)

BEER TAP CLEANING KIT REQUIRED TOOLS

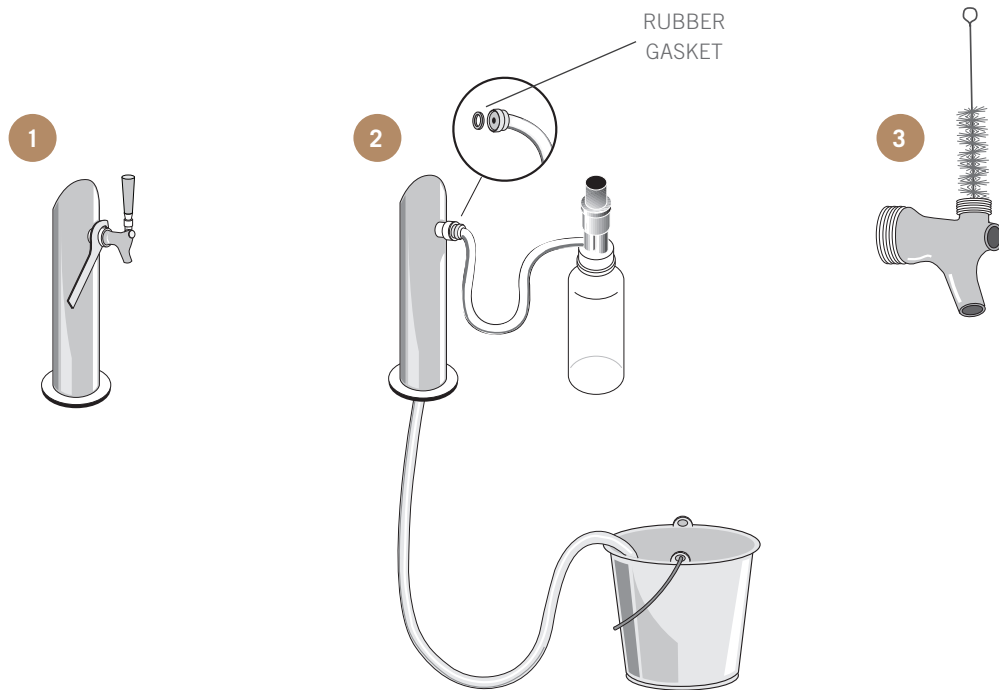
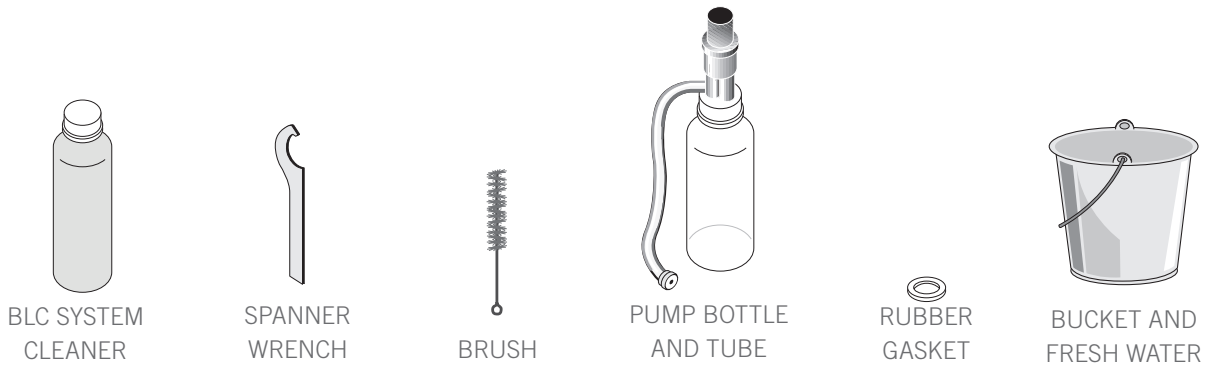

NOTE: AN ELECTRONIC CONTROL DISPLAY MAY REFLECT THE FLUCTUATING TEMPERATURES OF THE REFRIGERATION CYCLE, NOT THE PRODUCT TEMPERATURE. THE MOST ACCURATE METHOD TO DETERMINE AN APPLIANCE'S OPERATION IS TO VERIFY THE PRODUCT TEMPERATURE.

TRUE PRECISION CONTROL® OPERATION & APPLIANCE
COMPONENTS (ALL MODELS)

24 INCH REFRIGERATOR & FREEZER

24 INCH DUAL ZONE

24 INCH REFRIGERATOR FREEZER / DRAWERS

15 INCH REFRIGERATOR

HOME ALARM SYSTEM
(DUAL ZONE WINE CABINET ONLY)







PRESERVE THE MOMENT®

24 INCH REFRIGERATOR & FREEZER

(Freezer not available in glass door)

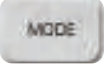

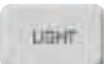
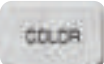





USER INTERFACE COMMANDS

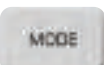

-  = Power unit off / on cuts power to all relays
-  = To display set point
-  = Press to change set point down
-  = Press to change set point up
-  = To turn on accent light – This will leave light on all the time even when the door is closed
-  = To switch color LED's – 14 color TruLumina®. 
-  = To turn on door ajar alarm & high temperature alarm – Door ajar alarm activates after 7 minutes.

- Refrigerator – High temperature alarm activates after one consecutive hour at or above 50°F.
- Freezer – High temperature alarm activates after one consecutive hour at or above 20°F. Wine
- Wine Cabinet – High temperature alarm activates after one consecutive hour at or above 70°F.

KEY COMBINATIONS

-  +  = Lock / Unlock Keypad
-  +  = Sabbath Mode
-  +  = Showroom Mode – Shuts off all refrigeration components. Displays set point. Lights are fully functional.
-  +  = Toggle °C / °F

24 INCH

TRUE ALL REFRIGERATOR / FREEZER COMPONENTS

TUR / TUF



24 INCH

TRUE BEVERAGE CENTER COMPONENTS

TBC



24 INCH

TRUE WINE CABINET COMPONENTS

TWC



24 INCH

TRUE BEVERAGE DISPENSER

TUR-24BD



24 INCH

TRUE DUAL BEVERAGE DISPENSER







TUR-24DD













24 INCH DUAL ZONE

USER INTERFACE COMMANDS

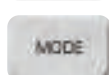

-  = Power, cuts power to all relays, resumes pulldown.
-  = To display set point
-  = Press to change set point down, hold to scroll down.
-  = Press to change set point up, hold to scroll up.
-  = To turn on accent light – This will leave light on all the time even when the door is closed
-  = To turn on door ajar alarm & high temperature alarm – Door ajar alarm activates after 7 minutes.
 - High temperature alarm activates after one consecutive hour at or above 70°F.

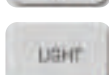
KEY COMBINATIONS

-  +  = Lock / Unlock Keypad (UPPER)
-  +  = Sabbath Mode (UPPER)
-  +  = Showroom Mode – Shuts off all refrigeration components. Displays set point. Lights are fully functional.
-  +  = Toggle °C / °F
-  +  = To switch color LEDs – 14 color TruLumina®. 

24 INCH

TRUE WINE CABINET - DUAL ZONE COMPONENTS







TWC-DZ



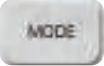





24 INCH REFRIGERATOR / FREEZER DRAWERS

USER INTERFACE COMMANDS

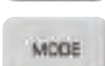

-  = Power unit off / on cuts power to all relays
-  = To display set point
-  = Press to change set point down
-  = Press to change set point up
-  = To turn on accent light – This will leave light on all the time even when the door is closed
-  = To switch color LED's – 14 color TruLumina®. 
-  = To turn on door ajar alarm & high temperature alarm – Door ajar alarm activates after 7 minutes.
 - Refrigerator – High temperature alarm activates after one consecutive hour at or above 50°F.
 - Freezer – High temperature alarm activates after one consecutive hour at or above 20°F.

KEY COMBINATIONS

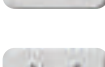
-  +  = Lock / Unlock Keypad
-  +  = Sabbath Mode
-  +  = Showroom Mode – Shuts off all refrigeration components. Displays set point. Lights are fully functional.
-  +  = Toggle °C / °F

24 INCH

TRUE REFRIGERATED DRAWERS

TUR-24D



24 INCH

TRUE FREEZER DRAWERS TUF-24D

LOCATION OF
SERIAL TAG



EXCLUSIVE TRUE®-GLIDE
SOFT-CLOSE FEATURE
FOR BOTH DRAWERS



REMOVABLE KICK PLATE
FOR EASY CLEANING

15 INCH



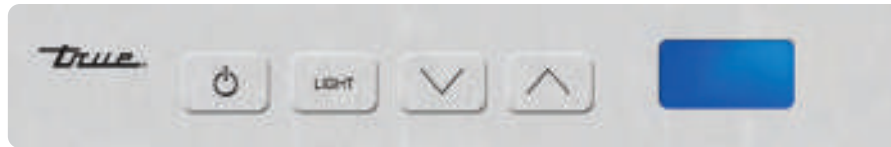

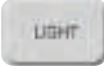





USER INTERFACE COMMANDS

Control is located behind the user interface and can be accessed by removing 3 Phillips screws. This will also give you access to the user interface, and LED driver. Control sequence is as follows:

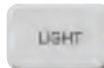

-  = Power, cuts power to all relays, resumes pulldown.
-  = To turn on accent light.
-  = Press to change set point down, hold to scroll down.
-  = Press to change set point up, hold to scroll up.

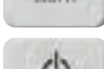
KEY COMBINATIONS

-  +  = Lock / Unlock Keypad
-  +  = Sabbath Mode
-  +  = Showroom Mode – Shuts off all refrigeration components. Displays set point. Lights are fully functional.
-  +  = To switch color LEDs – 14 color TruLumina®. 
-  +  = To turn on door ajar alarm & high temperature alarm – Door ajar alarm activates after 7 minutes.
 - Refrigerator – High temperature alarm activates after one consecutive hour at or above 50°F.
 - Wine Cabinet – High temperature alarm activates after one consecutive hour at or above 70°F.

15 INCH

TRUE BEVERAGE DISPENSER

TUR-15BD

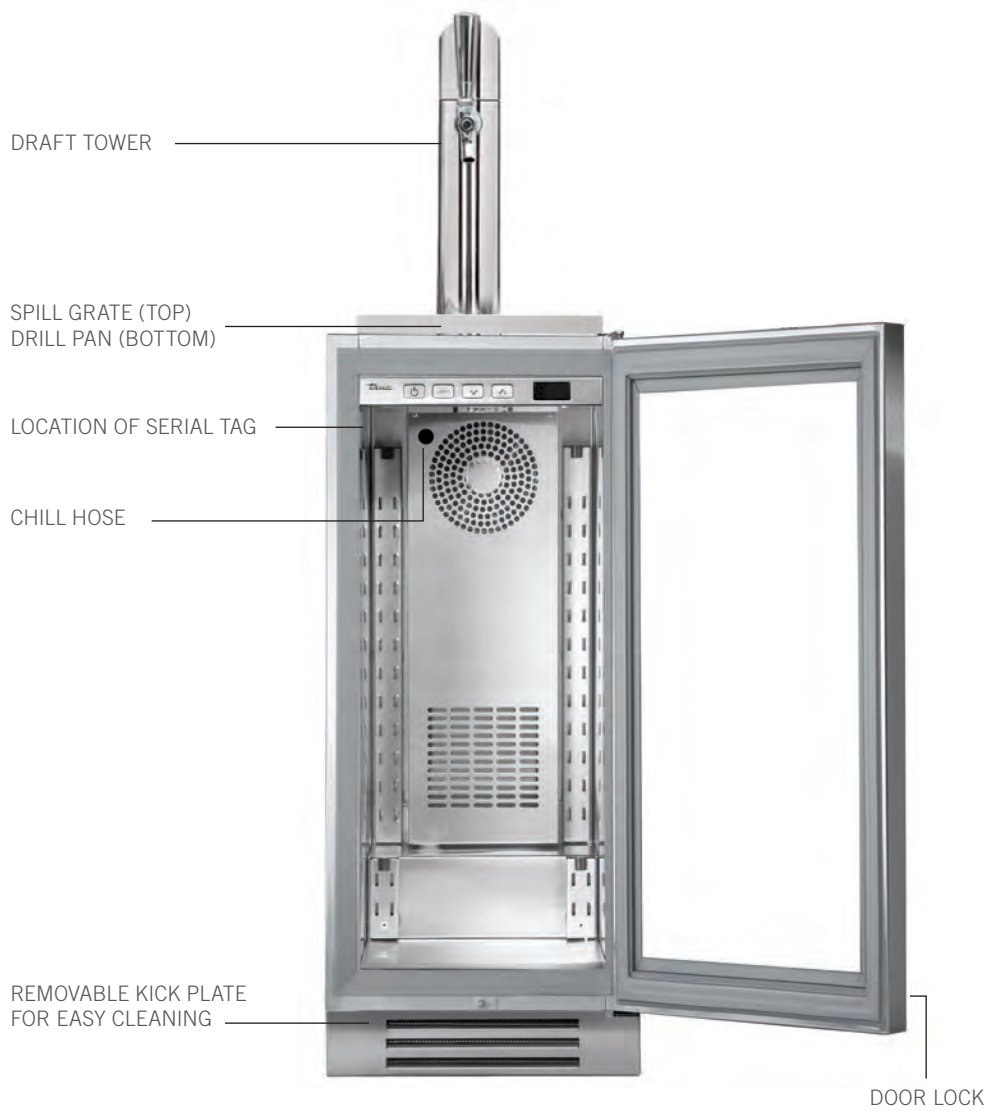

15 INCH

TRUE ALL REFRIGERATOR COMPONENTS

TUR



15 INCH

TRUE WINE CABINET COMPONENTS

TWC

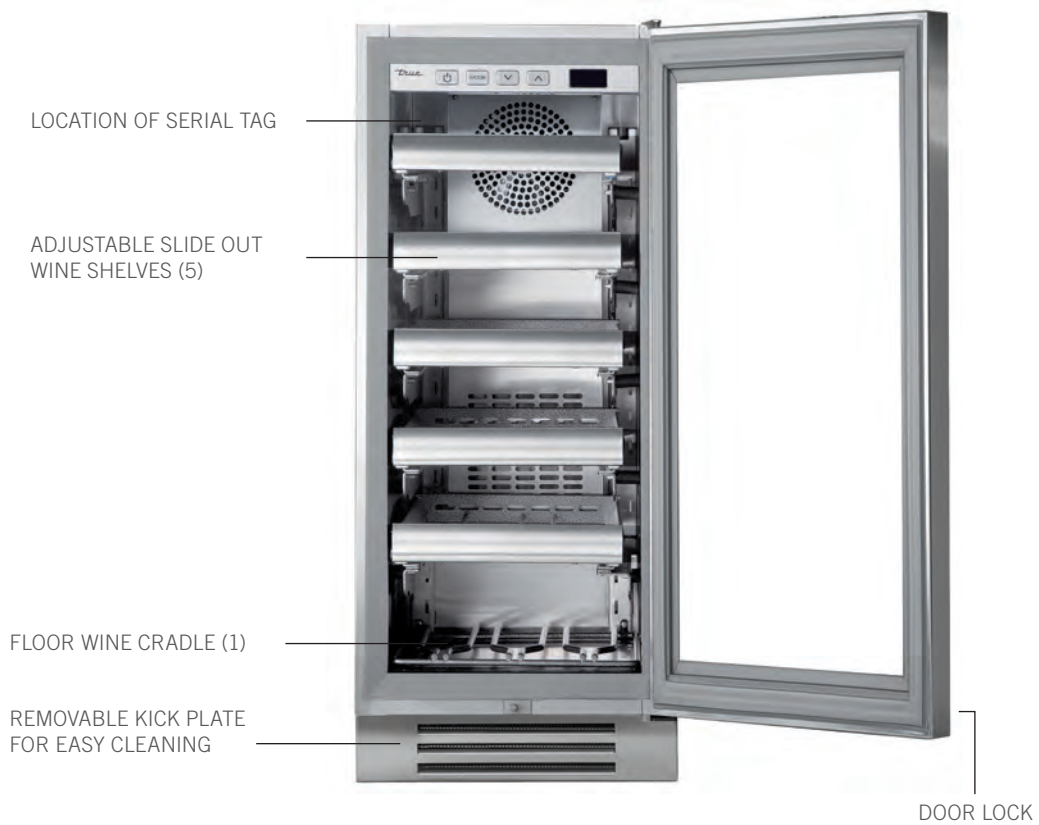

HOME ALARM SYSTEM – DUAL ZONE WINE CABINET ONLY

Dual Zone wine units are provided with three wires located behind the kick-plate that may be connected to a home alarm system. These connections are for low voltage, low current circuits similar to those used as signals for alarms on doors and windows. Refer to the specifications of your alarm system to determine the type of circuit used.

The color codes for the different circuits are as follows:

- Normally closed contacts: White with black and violet
- Normally open contacts: White with blue and black
- Common: White with black

CAUTION: ANY UNUSED TERMINALS SHOULD BE FULLY INSULATED AND ALL WIRES SHOULD BE SECURED AWAY FROM MOVING PARTS AND SHARP EDGES.



CONDENSER COIL CLEANING

INTERIOR ACCESSORIES

CONDENSATION

DRAWER REMOVAL, INSTALLATION & ADJUSTMENT

APPLIANCE CARE & CLEANING

SERVICING & REPLACING COMPONENTS

HANDLE TIGHTENING

CONTACT INFORMATION

SERIAL LABEL LOCATION



PRESERVE THE MOMENT®

CONDENSER COIL CLEANING

Keeping the condenser coil clean minimizes required servicing and lowers electrical cost. Warranty does not cover cleaning the condenser coil.



WARNING! Electrical shock or burn hazard. Unplug the unit or turn off the power supply before proceeding.

DO NOT clean appliance with a pressure washer or hose.



CAUTION! Risk of eye injury from debris. Eye protection is recommended.



CAUTION! Coil fins are sharp. Gloves are recommended.

NOTE: DO NOT PLACE ANY FILTER MATERIAL IN FRONT OF THE CONDENSER COIL.

REQUIRED TOOLS

Required tools include (but may not be limited to) the following:

- Gloves
- Eye Protection
- Stiff Bristle Brush
- Vacuum Cleaner
- Flashlight
- Tank of Compressed Air

PROCEDURE

1. Remove the kickplate. See fig. 1.
2. With a stiff bristle brush, carefully clean accumulated dirt from the front coil fins. See fig. 2.
3. With the dirt removed from the surface of the coil, use a flashlight to verify you can see through the coil and observe the condenser fan blade spinning. See fig. 3.
4. If the view is clear, reinstall the kickplate, restore power, and verify correct operation.
5. If the view is not clear, gently blow compressed air or CO₂ through the coil until it is clean.
6. Carefully vacuum any dirt around the condensing unit area.
7. Reinstall the kickplate, restore power, and verify correct operation.

INTERIOR ACCESSORIES

All removable interior accessories are dishwasher safe.

CONDENSATION

Excessive condensation can be caused by leaving the door/drawer open for long periods of time or running the appliance with little to no product inside.



FIG. 1. Pull the kickplate off the magnets.

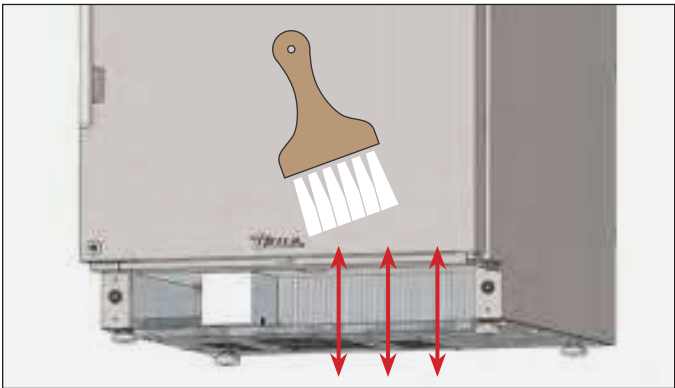

FIG. 2. Never brush across coil fins.

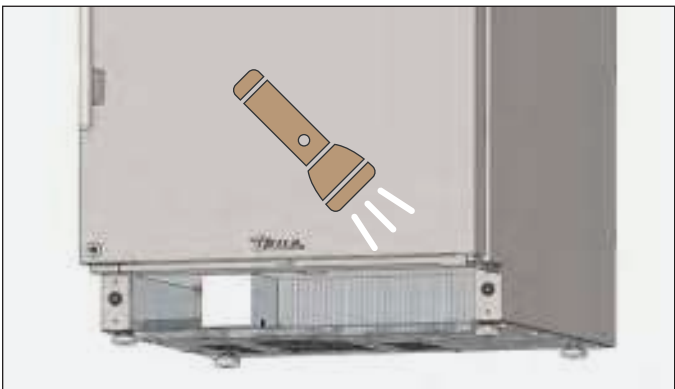

FIG. 3. Verify all blockages have been removed.

DRAWER REMOVAL, INSTALLATION & ADJUSTMENT

REQUIRED TOOLS

Required tools include (but may not be limited to) the following:

- Phillips screwdriver

REMOVAL

1. Open the drawer.
2. Remove the drawer screws. See fig. 1.
3. Lift the drawer from the slides.
4. Remove the slide adjustment bracket and drawer slide assembly. See fig. 2.
5. Repeat step 4 on the opposite side.

INSTALLATION

1. Install the slide assembly and the adjustment bracket. See fig. 3.

NOTE: DO NOT FULLY TIGHTEN THE ADJUSTMENT BRACKET SCREWS.

2. Repeat step 1 on the opposite side.
3. Extend the drawer slides. See fig. 4.
4. Position the drawer. Then, install the drawer screws.

NOTE: BE SURE THE DRAWER LOCKS INTO PLACE.

5. Verify the drawer alignment. Adjust drawer alignment as needed. See “Adjustment” (pg. 87).
6. Tighten the alignment bracket screws.



FIG. 1. Drawer screw locations.



FIG. 2. Drawer slide and adjustment bracket screw locations.



FIG. 3. Adjustment bracket orientation. Left side shown.

DRAWER REMOVAL, INSTALLATION & ADJUSTMENT (CONT.)

ADJUSTMENT

1. Open the drawer.
2. With the adjustment bracket screws loosened, lift the drawer slide and the side of the drawer. Then, lower or raise the adjustment screw. See fig. 5.

NOTE: DO NOT LIFT THE DRAWER BY THE HANDLE.

3. Close the drawer and verify the alignment.
4. Repeat steps 1-3 as needed.
5. Tighten the alignment bracket screws.

NOTE: DO NOT LIFT THE DRAWER BY THE HANDLE.



FIG. 4. Extend the drawer slides.



FIG. 5. Drawer adjustment screw location. Left side shown. Drawer removed for illustration purposes.

APPLIANCE CARE & CLEANING



CAUTION: DO NOT USE ANY STEEL WOOL, ABRASIVE OR CHLORINE BASED PRODUCTS TO CLEAN STAINLESS STEEL SURFACES.

STAINLESS STEEL OPPONENTS

There are three basic things which can break down your stainless steel’s passivity layer and allow corrosion to form.

- Scratches from wire brushes, scrapers, and steel pads are just a few examples of items that can be abrasive to stainless steel’s surface.
- Deposits left on your stainless steel can leave spots. You may have hard or soft water depending on what part of the country you live in. Hard water can leave spots. Hard water that is heated can leave deposits if left to sit too long. These deposits can cause the passive layer to break down and rust your stainless steel. All deposits left from food prep or service should be removed as soon as possible.
- Chlorides are present in table salt, food, and water. Household and industrial cleaners are the worst type of chlorides to use.

STAINLESS STEEL CLEANING AND RESTORATION

Stainless steel cleaners must be free of phosphates, chlorine, chloride, and ammonia.

TRUE offers environmentally-friendly cleaner and polish through our True Store at <https://store.trueresidential.com/products/stainless-steel-clean-polish-kit>

CUSTOM PAINTED APPLIANCES AND HARDWARE

For painted doors and other surfaces, use a mild solution of soap and water with a soft microfiber cloth.

APPLIANCE CARE & CLEANING

8 TIPS TO HELP PREVENT RUST ON STAINLESS STEEL

- **Maintain the Cleanliness of Your Equipment** – Avoid build-up of hard stains by cleaning frequently. Use cleaners at the recommended strength (alkaline chlorinated or non-chloride).
- **Use the Correct Cleaning Tools** – Use non-abrasive tools when cleaning your stainless steel products. The stainless steel's passive layer will not be harmed by soft cloths and plastic scouring pads.
- **Clean Along Polishing Lines** – Polishing lines ("grain") are visible on some stainless steels. Always scrub parallel to polishing lines when visible. Use a plastic scouring pad or soft cloth when you cannot see the grain.
- **Use Alkaline, Alkaline-Chlorinated or Non-Chloride Cleaners** – While many traditional cleaners are loaded with chlorides, the industry is providing an ever increasing choice of non-chloride cleaners. If you are not sure of your cleaner's chloride content, contact your cleaner supplier. If they tell you that your present cleaner contains chlorides, ask if they have an alternative. Avoid cleaners containing quaternary salts, as they can attack stainless steel, causing pitting and rusting.
- **Rinse** – When using chlorinated cleaners, you must rinse and wipe dry immediately. It is better to wipe standing cleaning agents and water as soon as possible. Allow the stainless steel equipment to air dry. Oxygen helps maintain the passivity film on stainless steel.
- **Never Use Hydrochloric Acid (Muriatic Acid) on Stainless Steel** – Even diluted, hydrochloric acid can cause corrosion, pitting and stress corrosion cracking of stainless steel.
- **Water Treatment** – To reduce deposits, soften hard water when possible. Installation of certain filters can remove corrosive and distasteful elements. Salts in a properly maintained water softener can also be to your advantage. Contact a treatment specialist if you are not sure of the proper water treatment.
- **Regularly Restore & Passivate Stainless Steel** – Stainless steel gets its stainless properties from the protective chromium oxides on its surface. If these oxides are removed by scouring, or by reaction with harmful chemicals, then the iron in the steel is exposed and can begin to oxidize, or rust. Passivation is a chemical process that removes free iron and other contaminants from the surface of stainless steel, allowing the protective chromium oxides to re-form.

SERVICING & REPLACING COMPONENTS

NOTE: ANY APPLIANCE ADJUSTMENTS ARE TO BE MADE AFTER THE APPLIANCE HAS BEEN VERIFIED LEVEL AND PROPERLY SUPPORTED.

- Replace component parts with original equipment manufacturer (OEM) components. OEM parts minimize the risk of possible ignition due to incorrect parts. Use of non-OEM components may void TRUE's warranty.
- Contact the dealer or our parts department at **844-849-6179** or **TrueResidentialParts@truemfg.com** for replacement parts.
- Have a licensed service provider service your unit to minimize the risk of possible ignition due to incorrect parts or improper service and to ensure the operator's health and safety.
- Unplug the refrigerator/freezer before cleaning or making any repairs. Powering off an electronic control may not remove power from all components (e.g., light circuits, perimeter heaters, and evaporator fans).

HANDLE TIGHTENING

Tighten the handle with a 3/32" Allen wrench.

CONTACT INFORMATION

For any questions about installation, please contact your TRUE dealer or TRUE Residential Technical Support. Please have your model and serial number (see serial label location below) available so we can better assist you with your service- or parts-related inquiries.

CUSTOMER SERVICE

Phone: 888-616-8783
info@true-residential.com

WARRANTY DEPARTMENT

Phone: 844-849-6179
TrueResidentialWarranty@truemfg.com

TECHNICAL SUPPORT DEPARTMENT

Phone: 844-746-9423
TrueResidentialService@truemfg.com

SERIAL LABEL LOCATION

Your serial label contains important information such as your model name and serial number. The label is located on the upper left interior wall.

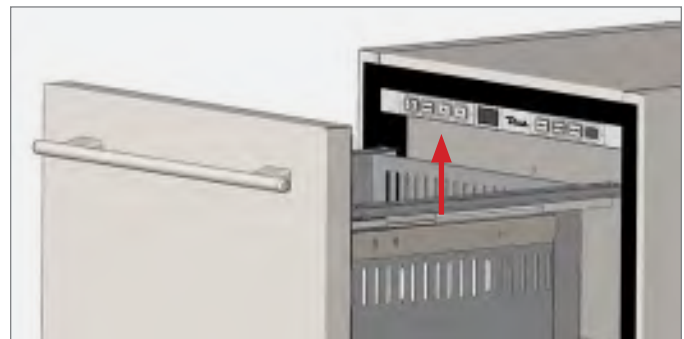

FREQUENTLY ASKED QUESTIONS

GENERAL QUESTIONS

BEVERAGE DISPENSER QUESTIONS

WINE APPLIANCE QUESTIONS

DRAWER APPLIANCE QUESTIONS



PRESERVE THE MOMENT®

FREQUENTLY ASKED QUESTIONS

FAQ'S — GENERAL

Q. How do I adjust the temperature?

A. See “Appliance Operation” starting on pg. 66.

Q. Why does the temperature on my display fluctuate?

A. An electronic control display may reflect the fluctuating temperatures of the refrigeration cycle, not the product temperature. The most accurate method to determine an appliance’s operation is to verify the product temperature.

Q. Why is my unit not cooling properly?

A. Verify there are no obstructions to the condenser coil (behind the front grill). Confirm the condenser area is clean. Unplug the unit and plug it back in or turn the circuit breaker off and back on.

Q. Why is there warm air coming from the bottom/front of the unit (grill/kickplate area)?

A. This is normal as heat dissipation is part of the refrigeration cycle.

Q. How do I adjust or remove a shelf from my current configuration?

A. See “Glass Shelf Adjustment” on pg. 52.

Q. Why is there condensation forming on the inside or outside of the unit?

A. Leaving the door open for a long period of time, or a unit that is running with little to no product inside, may cause excessive condensation. Verify your door/drawer gasket seals without gaps.

Q. What are the preset limits for the high temperature alarm?

A. The electronic temperature control will monitor temperatures and activate an alert if unsafe product temperatures are present for more than 60 min.

- For single and dual zone wine appliances, the alarm activates at 70°F (21°C)
- For refrigerators, the alarm activates at 50°F (10°C).
- For freezers, the alarm activates at 20°F (-6.7°C).

Q. How much distance is needed from the wall to have the hinge on the wall side and the door still open 90°?

A. 2” (50.8 mm).

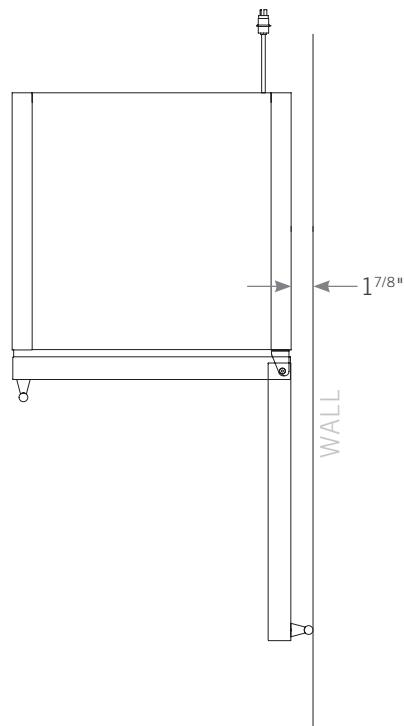

Q. Can I put two units flush against each other without spacing?

A. When installing two or more True units side-by-side, True recommends installing one (1) foam pad between the appliances (on either appliance) to prevent moisture from developing.

To order foam pads, contact our parts department at **844-849-6226** or TrueResidentialParts@TrueMfg.com.

Q. Does True sell overlay panels for overlay units?

A. No, for overlay panels reach out to your cabinet maker and provide them with the applicable overlay templates in “Custom Panel Specifications” starting on pg. 25.

Q. Does the overlay unit come with the handle(s)?

A. No, our handle(s) can be ordered as an accessory. Any pull can be added to your overlay drawer.

FAQ'S — GENERAL (CONT.)

Q. Do True units have a zero-clearance hinge?



A. Yes. No spacing is needed on either side of our unit. The unit can be placed flush with adjoining cabinetry and still open to 90°.

Q. What is the decibel rating of the unit?

A. 42-47 db.

Q. How do I change the lighting?

A. For models that include a color button, simply push the button until the desired color appears.

For 15" models without a color button, press  and the  at the same time until the desired color is reached.

For 24" Dual Zone models, press  and .

Q. My display shows REF. What does that mean?

A. The REF code is shown when the appliance does not reach the desired set temperature in the allotted time. The problem may be the door was left open or very hot product was loaded into the unit. To reset the code, power the unit off, and then power on the appliance. If the code returns, please contact True.

Q. I do not know a service company in my area. Who can I call?

A. Please contact our warranty department at **844-849-6179** or TrueResidentialWarranty@truemfg.com or visit our service locator on our website at <https://true-residential.com/service-locator/>.

Q. Can I install my freestanding unit outdoors?

A. While True undercounter units are UL rated for outdoor use, it is not recommended to install your undercounter unit freestanding outdoors. Instead, install the unit under cover (such as a countertop).

NOTE: GASKETS DO NOT PROVIDE A WATERTIGHT SEAL. TRUE RECOMMENDS INSTALLING YOUR UNIT SO THE COUNTERTOP OF YOUR OUTDOOR KITCHEN SHELTERS THE DOOR OR DRAWER GASKET.

Q. What should I do in the winter? Do I have to bring my unit inside? How cold can the weather get before there is a problem?

A. In regions with cold winters (consistently below 32°F (0°C)), True appliances should be turned off and emptied of all contents. If exposed to the elements, covering your appliance will extend its life and beauty.

FAQ'S — BEVERAGE DISPENSERS

Q. What type of tap system can be used with a True unit?

A. The provided tapper is a D-style low profile tapper. Other tappers are not provided by True. Contact your local beer distributor.

Q. Where can I get my CO₂ tank filled?

A. Fill your CO₂ tank at a gas supplier near you.

Q. What types of kegs can I fit in my beverage dispenser? What is the keg footprint?

A. Depending on the unit, you can fit a short quarter barrel, a slim quarter barrel, or a sixth barrel. See the figures below.

KEG GUIDE

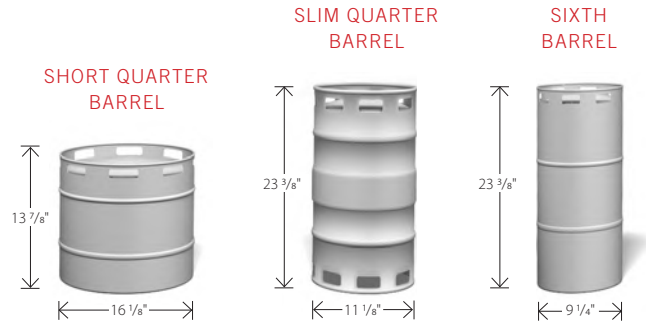

24" SINGLE TAP MODELS

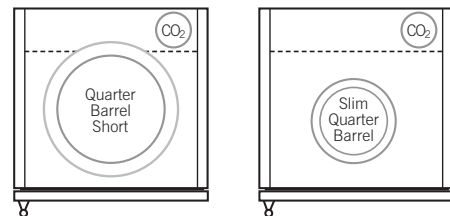

*With supplied wire shelf.

FREQUENTLY ASKED QUESTIONS

24" DUAL TAP MODELS

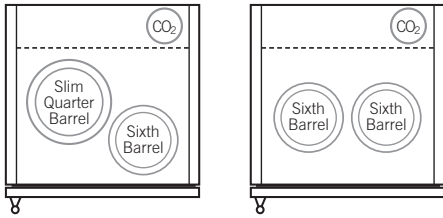

15" SINGLE TAP MODELS

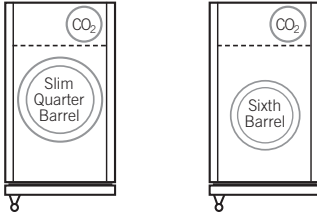

Q. Can my beverage dispenser dispense liquids other than beer?

A. True provides a “D” style coupler. If the product you are dispensing requires a different tapper, you must purchase it from a third-party supplier.

Q. Why is my beer not dispensing properly?

A. To minimize draft beer problems, always follow the recommended instructions for temperature and CO₂ pressures from your beer supplier. See beer problems and potential causes below.

FLAT BEER — FOAMY HEAD DISAPPEARS QUICKLY. BEER LACKS USUAL ZESTFUL BREWERY-FRESH FLAVOR

- CO₂ turned off when not in use
- Contaminated air source (associated with compressed air)
- Greasy glasses
- Not enough pressure
- Pressure shut off during night
- Loose tap or vent connection
- Sluggish pressure regulator
- Obstruction in lines

FALSE HEAD — LARGE SOAP-LIKE BUBBLES, HEAD DISSOLVES VERY QUICKLY

- Dry glasses
- Improper pour

- Pressure required does not correspond to beer temperature
- Coils or direct draw beer lines warmer than beer in keg
- Small lines into large faucet shanks
- Beer drawn improperly

WILD BEER — DRAWN BEER IS ALL FOAM AND NOT ENOUGH LIQUID

- Beer drawn improperly
- Faucet in bad or worn condition
- Kinks, dents, twists, or other obstructions in line
- Traps in beer lines
- Beer too warm in kegs or lines
- Too much pressure
- Creeping gauge causing too much pressure

CLOUDY BEER — BEER IN THE GLASS APPEARS HAZY (NOT CLEAR)

- Dirty glass or faucet
- Beer over chilled
- Beer temperature variance in keg. (Beer may have warmed up at some time)
- Hot spots in beer lines
- Cutting beer through faucet
- Beer line in poor condition
- Dirty lines
- Beer that has been frozen

BAD TASTE

- Dirty faucet
- Old or dirty beer lines
- Failure to flush beer lines with water after each empty keg
- Unsanitary conditions at bar
- Foul air or dirt in lines
- Oily air; greasy kitchen air
- Temperature of package too warm
- Dry glasses

FREQUENTLY ASKED QUESTIONS

FAQ'S — WINE APPLIANCES

Q. Why does the evaporator fan motor run constantly in my wine unit?

A. This is normal operation for wine units. The evaporator fan motor runs continuously to ensure even temperature throughout your appliance. The fan only stops when the door is opened to keep warm air from being circulated throughout the appliance.

Q. Can I store Magnum bottles?

A. Magnums fit on the floor rack, which holds five bottles. Also, the wine racks are removable to create additional space.

Q. Can I store Pinot/Bordeaux/Riesling bottles?

A. Yes. Almost all bottle varieties fit in your True wine appliance.

FAQ'S — DRAWER APPLIANCES

Q. Can I store a gallon of milk in my refrigerator drawer unit?

A. Yes. Please see the figure below.

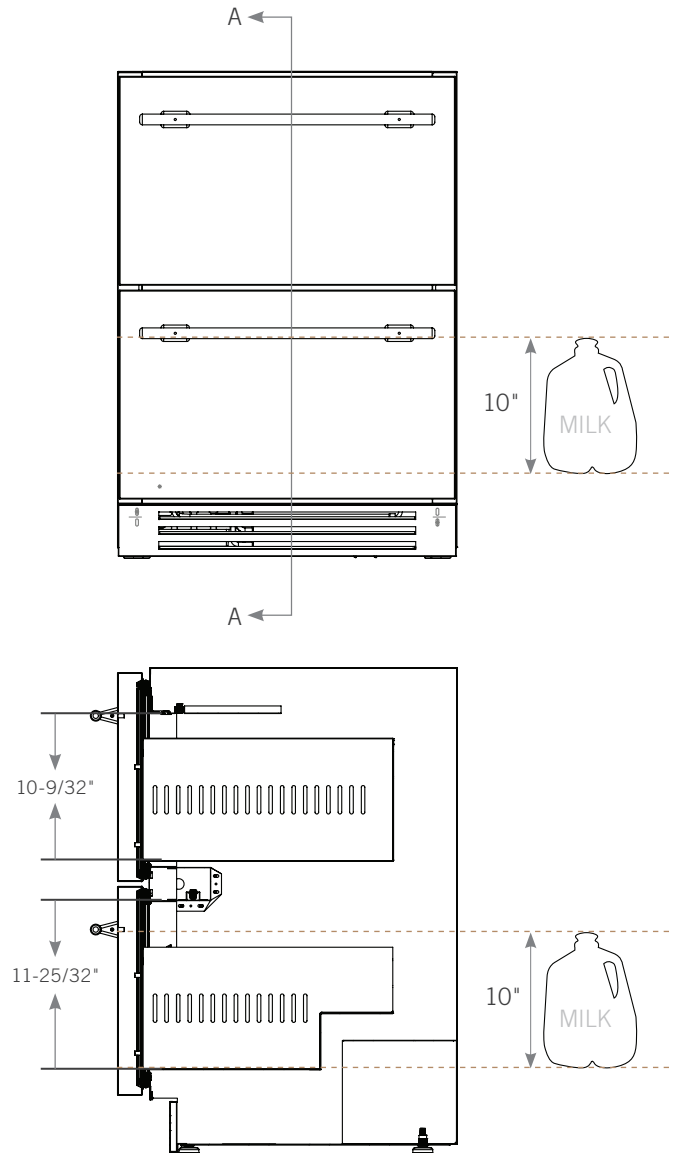

Scale 1 : 8

Q. What is the weight capacity of my drawer?

A. 66 lb (29.9 kg) per drawer.

TO VIEW AND DOWNLOAD THE WARRANTY INFORMATION FOR USA & CANADA, PLEASE SCAN THE QR CODE BELOW.



NOTES

KEY PACKET LOCATION

Keys are included inside the envelope.
Keep keys out of reach of children.

Las llaves están incluidas en el sobre.
Mantenga las llaves fuera del alcance de los niños.

Clés incluses dans l'enveloppe.
Tenir hors de portée des enfants.

CONTACT US

true-residential.com

636.240.2400 | toll free 888.616.8783



PRESERVE THE MOMENT®



838155-H

BP_236358_9.24