

# FAB50URCRB3



Product family	Refrigerator
Installation	Free-standing
Category	Top-mount
Cooling type	Total no-frost - Dual-flow cooling system
Defrost	Automatic
Hinge position	Right
EAN code	8017709321529



## Aesthetic



Aesthetics	Retro-style	Side color	Cream
Color	Cream	Logo	Applied
Finishing	Glossy	Door shelf profile color	Silver
Handle	External	Drawers profile color	Silver
Handle color	Old brass	Glass shelf profile color	Chromed
Logo color	Old brass	Display	LED
Side material	Steel	Display position	Internal

## Refrigerator compartment features



No. of adjustable shelves	2	Type of crisper cover	Glass
Number of fruit and vegetables drawers	1	LifePlus zone - 32°F	Yes
Type of adjustable shelves	Glass	Refrigerator lighting	LED
Crisper cover	Yes		

## Refrigerator Inner Door

Number of adjustable door shelves	3	No. of bottle shelves	1
-----------------------------------	---	-----------------------	---

## Other Refrigerator features



MultiFlow Yes

## Freezer features

No. of shelves	1	Freezer lighting	LED
Freezer lighting	Yes	Shelf type	Glass

## Freezer Inner Door

No. of adjustable door shelves 2

## Other Freezer features



Ice-maker	Yes	Fast-freezing compartment	Yes
Ice maker	Automatic		

## Other technical features



Display functions	Fast-freezing, ECO, Temperature alarm
Fast-freezing button	Yes
Door open alarm	Acoustic and visual
Temperature setting type	Electronic
No. of compressors	1
Refrigerant gas type	R600a
Compressor type	Inverter
Foam agent	Cyclopentane

## Performance / Energy Label NEW

Annual energy consumption	453 KWh/year	Noise level	41 dB(A) re 1 pW
Freezer volume	4.38 cu. ft.	Refrigerator volume	14.90 cu. ft.
Total volume	19.28 cu. ft.	Climatic class	SN, N, ST, T

## Electrical Connection







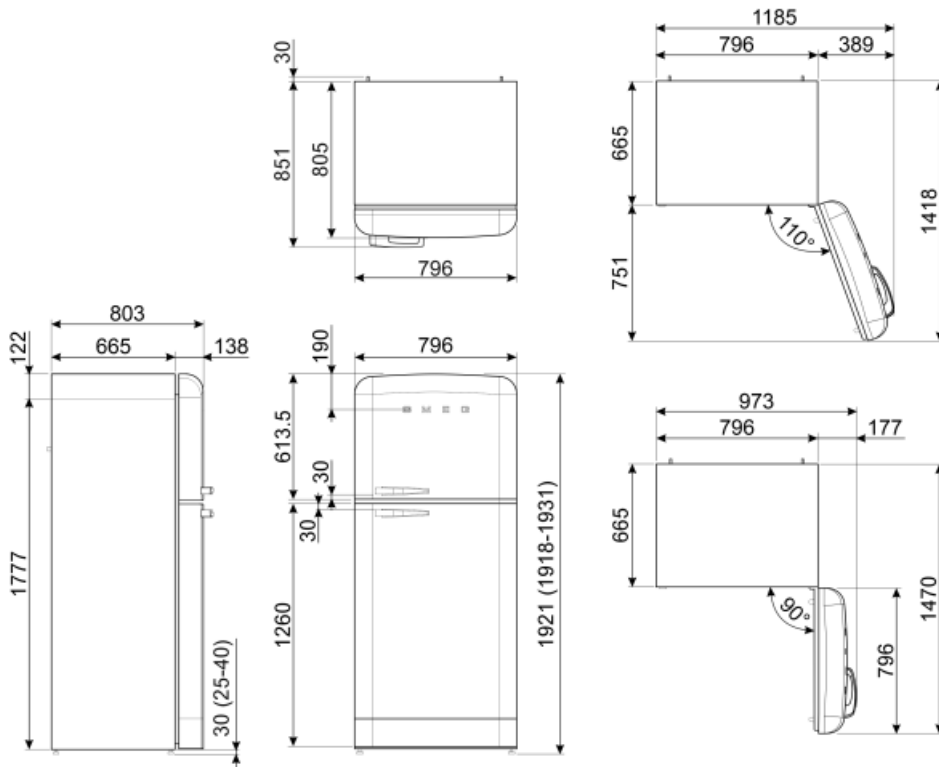

Plug	(A) USA & Mexico	Voltage (V)	120 V
------	------------------	-------------	-------

Electrical connection rating 197 W  
Current 2.6 A

Frequency (Hz) 60 Hz  
Power cord length 70 7/8 "



## Symbols glossary (TT)

	The automatic defrost system works by automatically defrosting at regular intervals eliminating the need to defrost altogether.		LED display: to show programmes, functions and options selected and the time to the end of the cycle.
	Economical mode: Analyzes fridge functioning during the activation and optimizes the operating cycle in order to reduce power consumption.		Fast freezing: The fast freezing function brings the temperature of the compartment down when activated a few hours prior to usage.
	LED interior lighting: is a more energy efficient and long lasting way of illuminating the interior of the appliance.		Life Plus 0°C: The temperature in the Lifeplus compartments is kept at 0°C, which preserves fresh meat and fish longer.
	Inverter technology: The evolution of Smeg's driers towards more intelligent and environmentally sustainable models has led to the choice of using Inverter technology with heat pumps, which reduces significantly energy consumption.		Air plus: keeps food fresher for longer.