

Cube Undermount Sink - CUX11015 | 122.0371.982

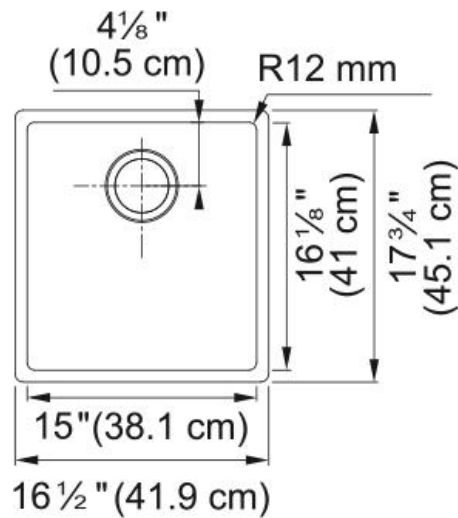

Elevate your kitchen experience with the Cube Series from Franke - a hand-crafted undermount sink collection that seamlessly marries Swiss precision with contemporary elegance. Our Cube sinks redefine sophistication with a smooth bowl design, providing a clean, modern aesthetic that effortlessly complements your kitchen decor. The easy-to-clean Pearl finish enhances the sink's visual appeal and simplifies maintenance, resisting stains and water spots for a lasting, pristine shine. Transform your kitchen into a haven of style and functionality with the Cube Series - where precision, design, and ease-of-use converge for an exceptional sink experience.

Aspect

Sink type	Sink
Type of material	Stainless steel
Number of bowls	1
Color	Steel
Surface finish	Pearl

Product Dimensions

Exterior size: right to left	16.5
Exterior size: front to back	17.756
Large bowl size: right to left	15
Large bowl size: front to back	16.142
Large bowl: depth	9.016

Installation

Minimum cabinet size	21"
----------------------	-----

Product specifications

Installation type	Undermount
Drain hole	3 1/2"
Position of drainer	No drainer

Product identification

Product brand	FRANKE
Product family	Maris
Collection	Cube
Certified by	IAPMO

Features

Drainers number	No drainer
Product reversibility	No

Faucet ledge	No
Strainer assembly included	No
Strainer Assembly	No waste kit
Overflow	No
Number of faucet holes	No faucet hole
Soap dispenser hole	No