



Jeep Wrangler (JL) 2024-Up Jeep Gladiator (JT) 2024-Up Rear Soundbar Speaker Adapter Plates

PRODUCT FEATURES

- Designed to adapt the factory 4" with up to a 6"-6.75" speaker with a tweeter option
- Retains the OE dome light
- Speaker depth: 4"
- Mounting plate/cutting template included
- Hardware included
- Harness included

WHAT'S IN THE BOX

- A) Replacement Grilles • B) Mounting Plate / Template • C) Speaker Harness
- Not Shown: (10) Coarse Thread Screws, (10) M4 Socket Head Screws, (1) Roll 1/4" Foam Tape

A



B



C

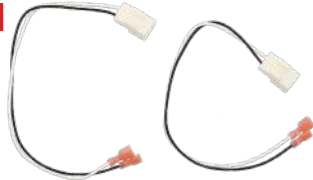

TABLE OF CONTENTS

Soundbar Removal.....	2
Soundbar Disassembly.....	3-4
Cutting Guide.....	5
Speaker Installation.....	6
Dome Light Installation.....	7
Replacement Grille Installation.....	8
Mounting Specifications.....	9

Visit MetraOnline.com for more detailed information about the product and up-to-date vehicle specific applications

TOOLS REQUIRED

- 5/64 Drill Bit
- 3/16 Allen Wrench
- 10mm Socket Wrench
- T-15 Torx
- T-30 Torx
- M3 Allen Key
- Phillips Bit
- Oscillating Saw or other Cutting Device

Attention! Let the vehicle sit with the key out of the ignition for a few minutes before removing the factory radio. When testing the aftermarket equipment, ensure that all factory equipment is connected before cycling the key to ignition.

SOUNDBAR REMOVAL

NOTE: It is highly recommended that the soundbar be removed for install of this speaker adapter kit. (Figure A)

1. Remove all panels along the top trim of the interior of the vehicle to gain access to the soundbar mounts.
2. Remove the (6) 10mm bolts that are securing the soundbar in place.
3. Unplug the harness and remove the soundbar from the vehicle.

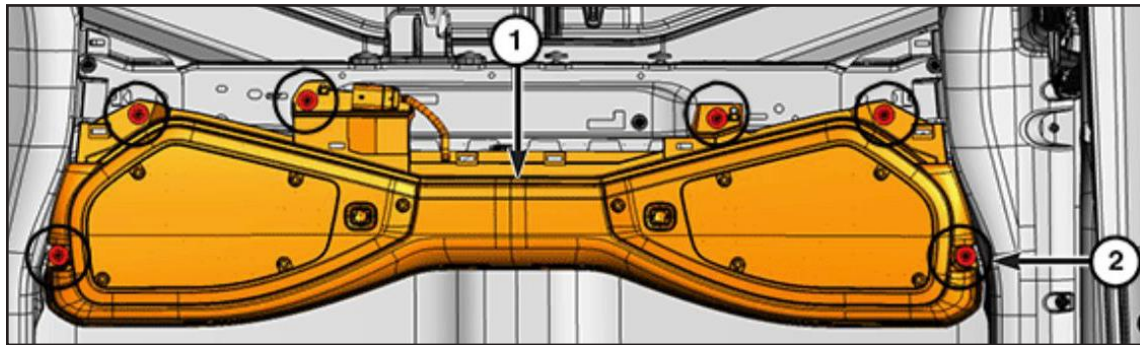

Figure A

Continue to Soundbar Disassembly

SOUNDBAR DISASSEMBLY

1. Remove (5) 3/16" screws holding the factory grille in place. (Figure A)
2. Disconnect the harness to the attached map light, and remove the factory grille panel. Put grille aside until time for reinstall. (Figure B)
3. Remove the (7) T-15 screws from the speakers in the sound bar and remove the speakers. (Figure C)
4. Remove the (5) T-30 screws holding the port assembly in place, and remove the port assembly. (Figure D)



Figure A



Figure B

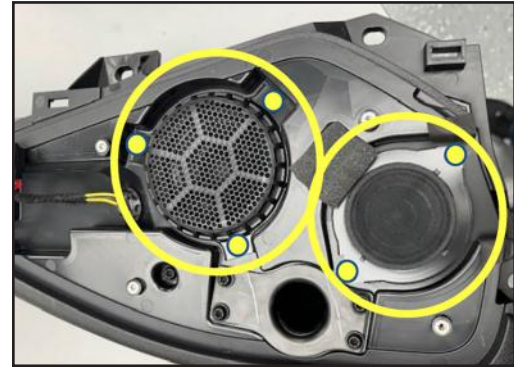

Figure C

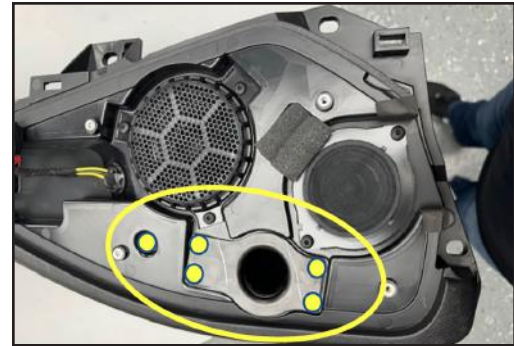

Figure D

SOUNDBAR DISASSEMBLY *CONT.*

5. Push the dome light harness along with the factory speaker harness into the soundbar as to not cut the wiring while cutting the interior structure of the soundbar. (Figure E)
6. Place the base plate in place and secure with (3) of the factory 3/16" bolts. (Figure F)
7. Trace the area highlighted in Figure G. This is the area that needs to be cut and removed. (Figure H)
8. Remove the template and see the area that needs to be cut. (Figure H)

Continue to Cutting Guide

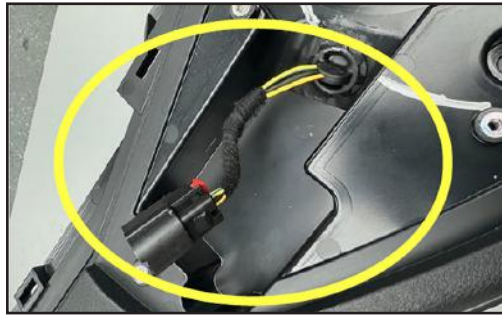

Figure E

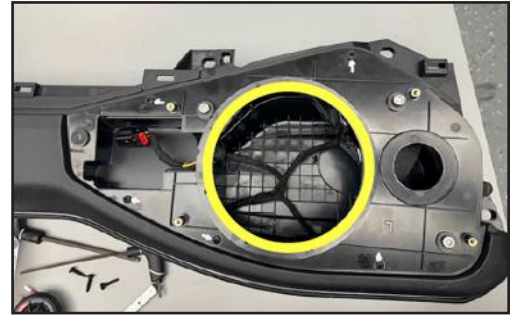

Figure G

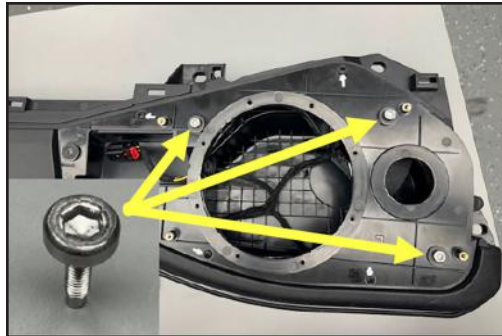

Figure F

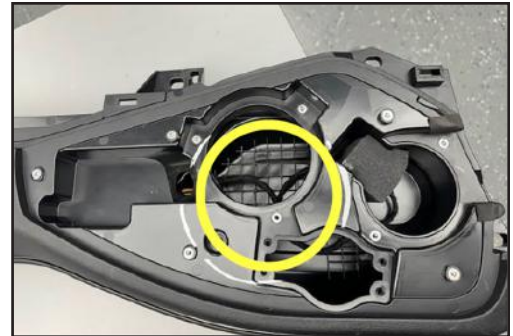

Figure H

CUTTING GUIDE

1. Cut the traced area carefully. (Figure A)
Be sure **not to cut through** to the back of the soundbar and **not to cut through** the wiring in the soundbar.
2. Figure B shows the section cut and removed.

Continue to Speaker Installation



Figure A

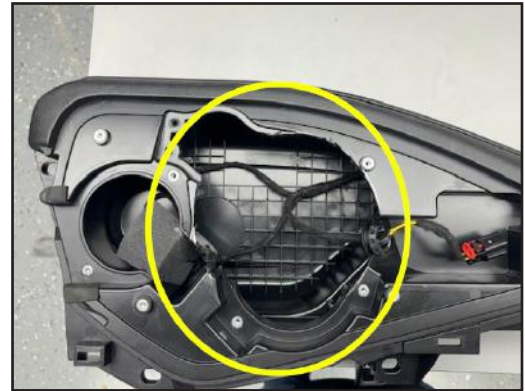

Figure B

SPEAKER INSTALLATION

1. Reinstall the base plate using (3) factory 3/16" screws. (Figure A)
2. Using a 5/64" drill bit, pre drill the (5) holes around the base plate. (Figure B)
3. Using the (5) 3/4" Pan Head Screws secure the mounting plate to the soundbar. This is what the speaker will mount to. (Figure B)
4. Install the speaker into the mounting plate to ensure proper fit.
5. If the fit is good, install the speaker into the mounting plate and connect with the included speaker harness. (Figure C)

NOTE: Not all tabs are needed for mounting the speaker into the speaker bracket. Remove the tabs as required. (Figure D)

NOTE: There is a center point marked on the template smaller circle that can be used as reference for cutting and installing a tweeter. (Figure E)

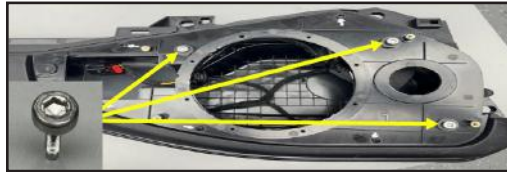

Figure A

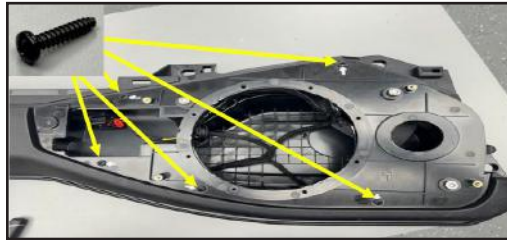

Figure B



Figure C

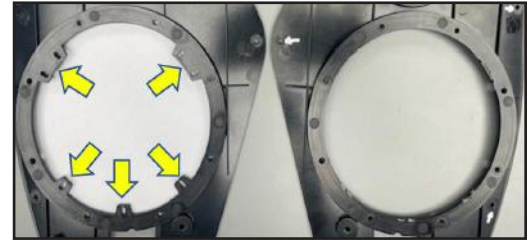
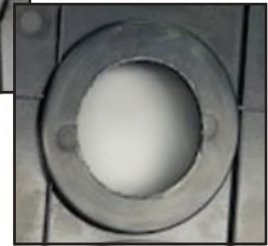

Figure D



Figure E



Continue to Dome Light Installation

DOMELIGHT INSTALLATION

1. Take the factory speaker grille that was removed earlier to remove the dome light. (Figure A)
2. Remove the (2) T-20 screws that attach the light to the factory speaker grille. (Figure B)
3. Install the dome light into the new replacement grille
4. Secure using the (2) T-20 screws that held it into the factory grille. (Figure D)



Figure A

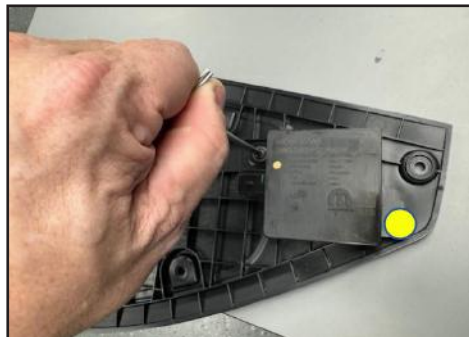

Figure B



Figure C



Figure D



Continue to Replacement Grille Installation

REPLACEMENT GRILLE INSTALLATION

1. Install the supplied 1/4" foam tape around the edge of the mounting plate to prevent the possibility of rattling. (Figure A)
2. Connect the harness into the dome light attached to the replacement grille. (Figure B)
3. Secure the replacement grille to the mounting plate using the (5) supplied M3 bolts. (Figure C)

Repeat the previous steps on the opposite side of the soundbar to complete the installation.

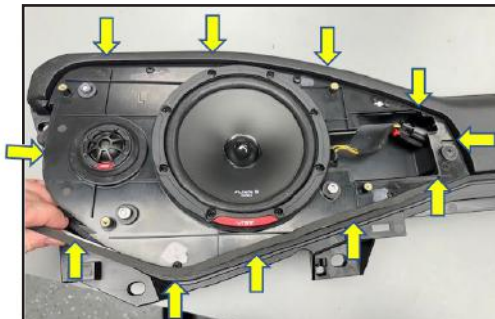

Figure A

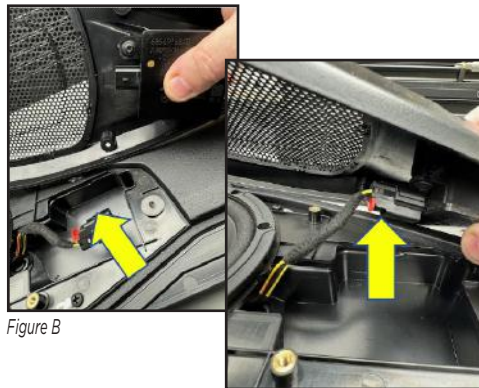

Figure B



Figure C



MOUNTING SPECIFICATIONS

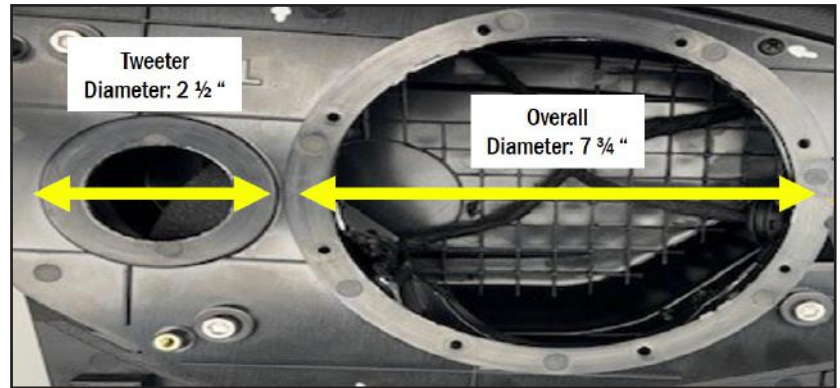
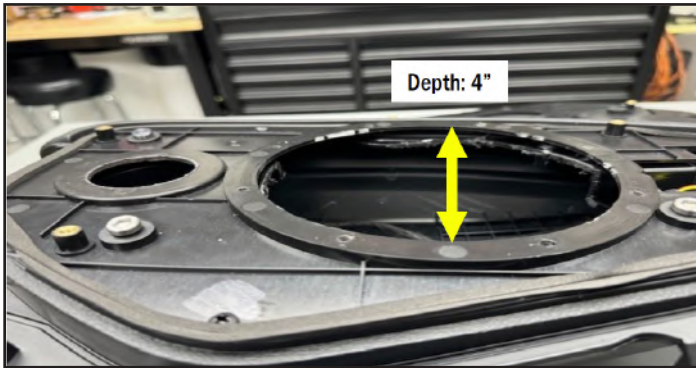



JP-1019

INSTALLATION INSTRUCTIONS

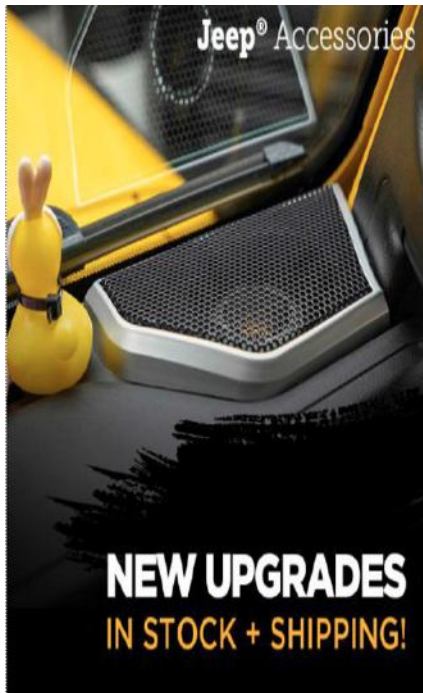

Scan the QR to check out all our Jeep Accessories and Heise LED Lighting for Jeep at

METRAPOWERSPORTS.COM



Having difficulties? We're here to help.



Contact our Tech Support line at:
386-257-1187



Or via email at:
techsupport@metra-autosound.com

Tech Support Hours (Eastern Standard Time)

Monday - Friday: 9:00 AM - 7:00 PM

Saturday: 10:00 AM - 5:00 PM

Sunday: 10:00 AM - 4:00 PM



Metra recommends MECP
certified technicians