

# Pioneer

## DMH-WT6000NEX

RDS AV RECEIVER

English

**HD Radio®**

Key Features:

Program Info

HD2/HD3

Digital Sound

Artist Experience

**SiriusXM®**  
READY

## Operation Manual

### Important (Serial number)

The serial number is located on the bottom of this unit. For your own security and convenience, be sure to record this number on the Limited Warranty sheet. Please visit [pioneerelectronics.com/warranty](http://pioneerelectronics.com/warranty) to download the warranty sheet, or you can receive a copy by calling 1-800-421-1404 or writing to Customer Support, Pioneer Electronics (USA) Inc., P.O. Box 1720, Long Beach, California 90801 USA.

[pioneerelectronics.com/warranty](http://pioneerelectronics.com/warranty)



# Contents

Thank you for buying this Pioneer product.  
Please read through these instructions so you will know how to operate your model properly. After you have finished reading the instructions, keep this document in a safe place for future reference.

## Important

The screen shown in the examples may differ from actual screens, which may be changed without notice for performance and function improvements.

■ <b>Precaution</b> .....	4
■ <b>About this manual</b> .....	6
■ <b>Important safety information</b> .....	7
■ <b>To avoid battery exhaustion</b> .....	9
■ <b>Protecting the LCD panel and screen</b> .....	10
■ <b>Parts and controls</b> .....	11
■ <b>Starting up the unit</b> .....	17
■ <b>Using the “PxLink” App for the AV main unit</b> .....	18
■ <b>Bluetooth® connection</b> .....	20
■ <b>Wi-Fi® connection</b> .....	23
■ <b>Customizing the home menu screen</b> .....	24
■ <b>Source/application</b> .....	26
■ <b>Apple CarPlay</b> .....	29
■ <b>Android Auto™</b> .....	34
■ <b>WebLink®</b> .....	39
■ <b>Hands-free phoning</b> .....	41
■ <b>Bluetooth audio</b> .....	46
■ <b>HD Radio™ Technology</b> .....	48
■ <b>SiriusXM® Satellite Radio</b> .....	52

■ iDatalink® .....	58
■ Metra Axxess .....	63
■ Playing data in a USB.....	66
■ Using external devices (AUX) .....	72
■ Displaying video images from the back camera/2nd camera .....	74
■ Updating the firmware wirelessly .....	76
■ Settings.....	78
Displaying the setting screen .....	78
Favorite menu.....	78
System settings .....	79
Theme settings.....	89
Audio settings .....	91
Communication settings.....	95
■ Other functions.....	98
■ Compatible iPhone models.....	101
■ Handling the USB connector.....	102
■ Detailed information for playable media .....	103
■ Specifications.....	107
■ Trademark · Copyright, etc.....	113
■ Troubleshooting .....	115
■ Error messages.....	118
■ Appendix .....	122

# Precaution

## To ensure safe driving

### WARNING

- LIGHT GREEN LEAD AT POWER CONNECTOR IS DESIGNED TO DETECT PARKED STATUS AND MUST BE CONNECTED TO THE POWER SUPPLY SIDE OF THE PARKING BRAKE SWITCH. IMPROPER CONNECTION OR USE OF THIS LEAD MAY VIOLATE APPLICABLE LAW AND MAY RESULT IN SERIOUS INJURY OR DAMAGE.
- To avoid the risk of damage and injury and the potential violation of applicable laws, this product is not for use with a video image that is visible to the driver.
- In some countries the viewing of video image on a display inside a vehicle even by persons other than the driver may be illegal. Where such regulations apply, they must be obeyed. If you attempt to watch video image while driving, the warning **“Viewing of front seat video source while driving is strictly prohibited.”** will appear on the screen. To watch video image on this display, stop the vehicle in a safe place and apply the parking brake. Please keep the brake pedal pushed down before releasing the parking brake.

## Camera function

With an optional rear view camera, you are able to use this product as an aid to keep an eye on trailers, or backing into a tight parking spot.

### WARNING

- SCREEN IMAGE MAY APPEAR REVERSED.
- USE INPUT ONLY FOR REVERSE OR MIRROR IMAGE REAR VIEW CAMERA. OTHER USE MAY RESULT IN INJURY OR DAMAGE.

### CAUTION

The rear view mode is to use this product as an aid to keep an eye on the trailers, or while backing up. Do not use this function for entertainment purposes.

## Failure to operate

### After-sales service for Pioneer products

Please contact the dealer or distributor from which you purchased the product for after-sales service (including warranty conditions) or any other information. In case the necessary information is not available, please contact the companies listed below.

Please do not ship your product to the companies at the addresses listed below for repair without making advance contact.

–USA&CANADA

Pioneer Electronics (USA) Inc.

CUSTOMER SUPPORT DIVISION

P.O. Box 1720 Long Beach, CA 90801-1720, U.S.A

800-421-1404

For warranty information, please see the Limited Warranty sheet.

For the Limited Warranty sheet, please see Important (Serial number) on the cover of this manual.

- When taking this product to the dealer or authorized Pioneer Service Station, make sure to bring both the unit and LCD display.

## Visit our website

Visit us at the following site:

<https://www.pioneerelectronics.com/PUSA/>

<https://www.pioneerelectronics.ca/POCEN/>

- 1 Register your product.**
- 2 Receive updates on the latest products and technologies.**
- 3 Download owner's manuals, order product catalogs, research new products, and much more.**
- 4 Receive notices of software upgrades and software updates.**





## Notes on internal memory

- The information will be erased by disconnecting the yellow lead from the battery (or removing the battery itself).
- Some of the settings and recorded contents will not be reset.

# About this manual

- This manual uses diagrams of actual screens to describe operations. However, the screens on some units may not match those shown in this manual depending on the model used.

## Meanings of symbols used in this manual

	This indicates to touch the appropriate soft key on the touch screen.
	This indicates to touch and hold the appropriate soft key on the touch screen.
	This indicates to swipe in the direction of the arrow on the touch screen.
	This indicates to drag in the direction of the arrow on the touch screen.

# Important safety information

## **WARNING**

- Do not attempt to install or service this product by yourself. Installation or servicing of this product by persons without training and experience in electronic equipment and automotive accessories may be dangerous and could expose you to the risk of electric shock, injury or other hazards.
- Do not allow this product to come into contact with liquids. Electrical shock could result. Also, damage to the product, smoke, and overheating could result from contact with liquids.
- If liquid or foreign matter should get inside this product, park your vehicle in a safe place, turn the ignition switch off (ACC OFF) immediately and consult your dealer or the nearest authorized Pioneer Service Station. Do not use this product in this condition because doing so may result in a fire, electric shock, or other failure.
- If you notice smoke, a strange noise or odor from this product, or any other abnormal signs on the LCD screen, turn off the power immediately and consult your dealer or the nearest authorized Pioneer Service Station. Using this product in this condition may result in permanent damage to the system.
- Do not disassemble or modify this product, as there are high-voltage components inside which may cause an electric shock. Be sure to consult your dealer or the nearest authorized Pioneer Service Station for internal inspection, adjustments or repairs.

### **Before using this product, be sure to read and fully understand the following safety information:**

- Do not operate this product, any applications, or the rear view camera option (if purchased) if doing so will divert your attention in any way from the safe operation of your vehicle. Always observe safe driving rules and follow all existing traffic regulations. If you experience difficulty in operating this product, pull over, park your vehicle in a safe location and apply the parking brake before making the necessary adjustments.
- Never set the volume of this product so high that you cannot hear outside traffic and emergency vehicles.
- To promote safety, certain functions are disabled unless the vehicle is stopped and the parking brake is applied.
- Keep this manual handy as a reference for operating procedures and safety information.
- Do not install this product where it may (i) obstruct the driver's vision, (ii) impair the performance of any of the vehicle's operating systems or safety features, including air bags or hazard lamp buttons or (iii) impair the driver's ability to safely operate the vehicle.

- Please remember to fasten your seat belt at all times while operating your vehicle. If you are ever in an accident, your injuries can be considerably more severe if your seat belt is not properly buckled.
- Never use headphones while driving.
- Rear visibility systems (backup cameras) are required in certain new vehicles sold in the U.S. and Canada. U.S. regulations began according to a two year phase-in on May 1, 2016, and both the U.S. and Canada require that all such vehicles manufactured on or after May 1, 2018 have rear visibility systems. **Owners of vehicles equipped with compliant rear visibility systems should not install or use this product in a way that alters or disables that system's compliance with applicable regulations.** If you are unsure whether your vehicle has a rear visibility system subject to the U.S. or Canadian regulations, please contact the vehicle manufacturer or dealer.

If your vehicle has a compliant backup camera that displays the backup view through the factory receiver, do not use the Pioneer receiver unless it is connected to and displays the same view as the factory backup camera. Connection to the factory backup camera will require an adaptor, sold separately. Not all vehicles may be able to connect. Please check with a qualified professional installer for installation options specific to your vehicle.

# To avoid battery exhaustion

Be sure to run the vehicle engine while using this product. Using this product without running the engine can drain the battery.

 **WARNING**

Do not install this product in a vehicle that does not have an ACC wire or circuitry available.



# Protecting the LCD panel and screen

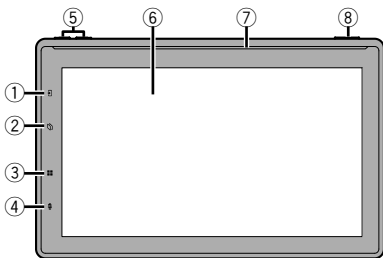

- Do not expose the LCD screen to direct sunlight when this product is not used. This may result in LCD screen malfunction due to the resulting high temperatures.
- If you use your mobile phone close to the LCD screen and the image gets distorted in the form of spots, colored stripes, etc., move your cellular phone away from the screen.
- To protect the LCD screen from damage, be sure to touch the touch panel keys only with your finger and do so gently.
- A shatterproof film is attached to the unit's display. This film cannot be taken off or replaced with an alternative film. There may be glue on the edge of the film. However, this does not affect the usability of this unit.

# Parts and controls

## Main unit



<p>①</p> 	<ul style="list-style-type: none"> <li>• Touch when the main unit and the iPhone/smartphone are not connected via Bluetooth to display the Bluetooth connection screen.</li> <li>• When the main unit and the iPhone/smartphone are connected via Bluetooth, the screen that is displayed varies depending on the configuration of [Companion App Key settings].             <ul style="list-style-type: none"> <li>– When [PxLink] is set: Touch when PxLink app is linked with the main unit to display the PxLink app of the iPhone/smartphone at the front. Touch when PxLink app is not linked with the main unit to display a screen with information on downloading the PxLink app.</li> <li>– When [Phone] is set: Displays the phone screen of the running Apple CarPlay or Android Auto. Touch when Apple CarPlay or Android Auto is not running to display the call history screen of the device connected via Bluetooth.</li> </ul> </li> </ul> <p><b>NOTE</b></p> <p>If the main unit and the iPhone/smartphone are not connected via Bluetooth, and are also not linked with the PxLink app, the illumination color is different from the other keys.</p> <p>For details on the setting method, see [Companion App Key settings] under System settings (page 83).</p>
<p>②</p> 	<ul style="list-style-type: none"> <li>• Touch when Apple CarPlay or Android Auto is running to display the screen that was last displayed on Apple CarPlay or Android Auto.</li> <li>• Touch when Apple CarPlay or Android Auto is not running to display mobile device search or selection screen.</li> </ul>

③		Touch to display the home menu screen. Touch and hold to power off. To power back on, touch any button.
④		Touch to activate the voice recognition mode such as Siri when the iPhone is connected to the unit via Bluetooth or USB. Touch when connected to Android Auto to start Android Auto voice recognition. Touch and hold to display the mobile device search or selection screen.
⑤		The volume is adjusted each time the buttons are pressed. Although the volume can also be adjusted by touching and holding the buttons, the adjustment performed by touching and holding the + button stops at a certain limit.
⑥	LCD screen	
⑦	Luminous bar	This bar lights up according to the music or audio being played, or the directions of the application being used on Apple CarPlay or Android Auto. For details, see [Luminous Bar settings] (page 80) in System settings.
⑧	MUTE	This button temporarily turns off the volume to mute. Cancel the mute state either by pressing the button one more time or by operating the volume buttons.



## Using the touch panel

You can operate this product by touching the keys on the screen directly with your fingers.

### NOTE

To protect the LCD screen from damage, be sure to touch the screen gently, only with your finger.

### Common touch panel keys

- : Returns to the previous screen.
- : Close the screen.

## Operating list screens

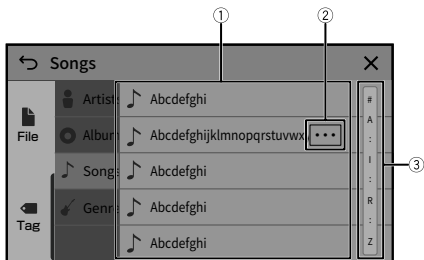

- |   |   |
|---|---|
| ① | <b>Touching an item on the list allows you to narrow down the options and proceed to the next operation.</b><br>Drag the list to view any hidden items.   |
| ② | <b>Appears when not all the characters can be displayed in the display area.</b><br>If you touch the key, the remaining characters will display via scroll.<br><b>NOTE</b><br>This function is available only when you stop your vehicle in a safe place and apply the parking brake. |
| ③ | <b>Appears when items cannot be displayed on a single page.</b><br>Drag the side bar or the initial search bar to view any hidden items.  |

## Operating the time bar

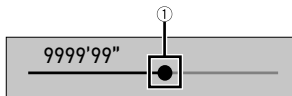

- |   |  |
|---|--|
| ① | <b>You can change the playback point by dragging the key.</b><br>The playback time corresponding to the position of the key is displayed while dragging the key. |
|---|--|

# Home menu screen

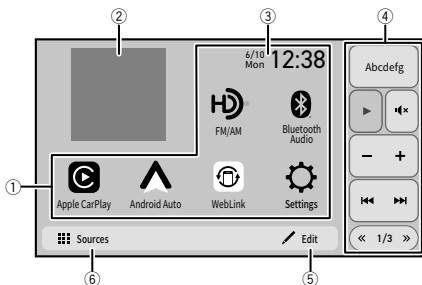

<p>①</p>	<p><b>Favorite source/application area</b> Touch to see the selected source/application. The source/application to be displayed can be changed as desired (page 24).</p> <p><b>NOTE</b> If linking to PxLink app or update of the firmware is not complete, the settings icon and setting items will be displayed with a red badge.</p>
<p>②</p>	<p><b>Album art</b> The artwork of the audio currently being played is displayed.</p> <p><b>NOTE</b> The artwork may not be displayed depending on the audio source.</p>
<p>③</p>	<p><b>Current time</b> Touch to set the clock display (page 98).</p>
<p>④</p>	<p><b>Shortcuts</b> Functions frequently used are preset (page 16). The displayed contents can be changed as desired with a dedicated application.</p>
<p>⑤</p>	<p><b>Edit</b></p> <ul style="list-style-type: none"> <li>• Changing the home menu screen layout (page 24).</li> <li>• Rearranging the displayed icons in the favorite source/application area (page 25).</li> </ul> <p><b>NOTE</b> Areas for which the layout can be changed and icons can be rearranged are areas ①, ②, and ③.</p>
<p>⑥</p>	<p><b>Sources</b> Touch to display all sources/applications.</p>

**TIP**

[Reconnect] is displayed on the home menu screen only when the Wi-Fi connection (Wireless Apple CarPlay or Android Auto) has failed or been disconnected automatically (page 99).

# Shortcuts

Shortcuts enable you to easily operate frequently used functions on the home menu screen.

## NOTES

- The position of the shortcuts on the home menu screen depends on the driving position setting (page 96).
- Some of the shortcut keys become unavailable depending on the source.
- Install PxLink app on your iPhone/smartphone (Android) and connect to the main unit to customize the shortcuts (page 18).

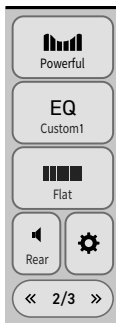

# Starting up the unit

## 1 Start the engine to boot up the system.

The [Select Program Language] screen appears.

From the second time on, the screen shown will differ depending on the previous conditions.

## 2 Select the language.

## 3 Touch .

The [Speaker Mode settings] screen appears.

## 4 Select the speaker mode.

Once the speaker mode is set, the setting cannot be changed unless this product is restored to the default settings. Restore the default settings to change the speaker mode setting (page 100).

### [Standard Mode]

4-speaker system with front and rear speakers, or a 6-speaker system with front and rear speakers and subwoofers.

### [Network Mode]

3-way system with a high range speaker, middle range speaker and subwoofer (low range speaker) for reproduction of high, middle and low frequencies (bands).

## WARNING

Do not use the unit in Standard Mode when a speaker system for 3-way Network Mode is connected to the unit. This may cause damage to the speakers.

## 5 Touch [OK].

Initial Legal Disclaimer screen appears.

## 6 Touch [OK].

A screen with information on downloading PxLink app is displayed.

## 7 Touch [Connect] or [Skip].

Touch [Connect] to display a screen for linking the main unit and PxLink app.

Touch [Skip] to display the home menu screen.

# Using the “PxLink” App for the AV main unit

PxLink is an app that allows you to configure and transfer various settings of this unit. You can also update this unit's firmware wirelessly by using this app.

## NOTE

If linking to PxLink app is not complete, the settings icon and [Companion App Info] setting item will be displayed with a red badge.

## Before you start

### WARNING

Do not attempt to operate the app while driving. Make sure to pull off the road and park your vehicle in a safe location before attempting to use the controls on the app.

You can download PxLink App on the App Store/Google Play.



This function is compatible with iPhones that have iOS 15.0 or later installed, or smartphones that have Android OS 9.0 or later installed.

## What kind of functions does the PxLink app have?

### Promoting the use of the unit







You can use your iPhone/smartphone (Android) to change the interface of the main unit or to operate the main unit.

### Examples

- Operating or customizing the shortcuts on the home menu screen
- Customizing the wallpaper
- Downloading the latest firmware

For details, refer to “Help” in the PxLink app.

## Starting procedure

- When connecting PxLink app for the first time on your Android device, disconnect Android Auto.
- 1** Turn on the Wi-Fi and Bluetooth functions on your iPhone or smartphone.
  - 2** Touch .
  - 3** Touch  then .
  - 4** Touch [Wi-Fi settings].
  - 5** Touch [Access point] and turn it [On].
  - 6** Touch .
  - 7** Touch [Connection].
  - 8** Touch .  
The unit starts to search for available devices, then displays them in the device list.
  - 9** Touch  in the list.  
A connection confirmation message appears on the screen.
  - 10** Touch [Yes] on the pop-up message.  
Transfer mode screen is displayed.
  - 11** Open PxLink app on the connected iPhone or smartphone, and add the main unit on the Bluetooth connection screen of the app.
  - 12** Add the main unit on the Bluetooth LE Connection screen of the app.
  - 13** Follow the message displayed on the connected iPhone or smartphone to make a Wi-Fi connection with this unit.  
Receiver Internet Access connection is successfully established.



# Bluetooth® connection

## Starting procedure

- If five devices are already paired, the message confirming whether to delete the registered device is displayed. If you want to delete the device, touch [Agree]. If you want to delete other device, touch [Go to DeviceList] and delete the devices manually on the mobile device select screen.
- If your device supports SSP (Secure Simple Pairing), a six-digit number appears on the display of this product. Make sure that the six-digit number matches the one that is displayed on the mobile device before touching [Yes] to pair the device.
- The Bluetooth connection can also be made by detecting this product from the Bluetooth device. Before registration, make sure that [Visibility] in the [Bluetooth settings] menu is set to [On] (page 21). For details on Bluetooth device operations, refer to the operating instructions supplied with the Bluetooth device.
- Two cellular phones can be connected to this product at the same time (page 21).

**1** Turn on the Bluetooth function on the device.

**2** Display the connected Bluetooth device list screen on the device.

**3** Touch .

**4** Touch  then .

**5** Touch [Connection].

**6** Touch .

The unit starts to search for available devices, then displays them in the device list.

**7** Touch  in the list.

If you touch the device name, a connection with Apple CarPlay, Android Auto, or PxDLink app may be established.

**8** Touch [Yes] to pair with the device.



**9** Perform the pairing operation by operating the device.

It may take up to around 80 seconds for the Bluetooth connection to be complete. After the device is successfully registered, a Bluetooth connection is established by the system. Once the connection is established, the device name is displayed on the list.

## Connecting a third Bluetooth device (HFP only)

- 1 Perform pairing from an unconnected Bluetooth device when two Bluetooth devices are connected.  
Of the two connected devices, the first device is disconnected and the unconnected device is connected.

## Bluetooth settings

- 1 Touch  .
- 2 Touch  then  .
- 3 Touch [Bluetooth settings].

### CAUTION

Never turn this product off and disconnect the device while the Bluetooth setting operation is being processed.

Menu Item	Description
[Auto Connect] [On] [Off]	Select [On] to connect the last connected Bluetooth device automatically when using the hands-free phone function. • If two Bluetooth devices were connected the last time, the two devices are connected to this product automatically in the order that they are registered in the device list.
[Visibility] [On] [Off]	Select [On] to make this product visible to the other device.
[PIN Code Input]	Change the PIN code for Bluetooth connection. The default PIN code is "0000". <b>1 Touch [0] to [9] to input the pin code (up to 8 digits).</b> <b>2 Touch .</b>
[Device Information]	Displaying the device name and address of this product.
[Sound Quality settings] [Quality] [Connectivity]	Select [Quality] to prioritize the Bluetooth sound quality. Select [Connectivity] to prioritize the Bluetooth connection.

## Switching the connected Bluetooth device

- You can register up to five Bluetooth devices on this product (page 20).
- You can connect one of the registered devices to this product. In cases where the registered device is equipped with a phone function, a total of two devices can be

connected at the same time when using the phone function. If two of the five registered devices are already connected, the third device can only be used as an audio function. You can switch devices from the Switch Devices key on the Audio source screen.

- The icon for the cellular phone currently being used is displayed on the phone menu screen. If you connect two cellular phones to this product at the same time, you can switch between the cellular phones using the switch devices key. The contents of the phone menu are memorized for each connected cellular phone (page 41).
- The switch devices key will appear for some audio sources. The audio source may automatically switch to another source depending on the selected device.

# Wi-Fi® connection



By connecting your Wi-Fi certified mobile device to this product via Wi-Fi connection, you can use Apple CarPlay or Android Auto wirelessly.

See the following chapters for the procedure on how to use Apple CarPlay or Android Auto wirelessly.

- Apple CarPlay (page 31)
- Android Auto (page 36)

## Wi-Fi settings

This unit can be used as an access point for the infrastructure mode network. Use this unit as an access point to use Apple CarPlay or Android Auto via Wi-Fi network.

- 1 Touch .
- 2 Touch  then .
- 3 Touch [Wi-Fi settings].

Menu Item	Description
[Access point] [On] [Off]	Switches Wi-Fi connection on or off.
[Device Information]	Displays this unit's infrastructure mode network information.
[Password]	Displays the infrastructure mode network password.
[Password reset]	Touch [OK] to reset the infrastructure mode network password and set a new random password.

# Customizing the home menu screen

The [Settings] icon cannot be removed from the favorite source/application area. The [Apple CarPlay] icon and the [Android Auto] icon can be deleted from the favorite source/application area, but if Apple CarPlay or Android Auto is started, the respective icon is added automatically.

## NOTE

This function is available only when you stop your vehicle in a safe place and apply the parking brake.

## Adding the source icons to the favorite source/application area

- 1 Touch .
- 2 Touch [Edit].
- 3 Touch [Add].
- 4 Touch the icon you want to add to the favorite source/application area.

### TIPS

- The clock and the artwork can also be set to be shown or hidden.
- If the area is full, remove unneeded icons, or the artwork first.
- When you cancel adding, touch .

- 5 Touch [Done].

## Removing the displayed icons from the favorite source/application area

- 1 Touch .
- 2 Touch [Edit].
- 3 Touch [Delete].
- 4 Touch the icon you want to remove from the favorite source/application area.

#### TIPS

- The clock and the artwork can also be removed from the favorite source/application area.
- When you cancel removing, touch [Done].

**5** Touch [Done].

## Rearranging the icons in the favorite source/ application area

**1** Touch .

**2** Touch [Edit].

**3** Drag the icon to the desired position.

#### TIP

The clock display cannot be moved. However, it can be switched between a large size and small size by sorting the other icons.

**4** Touch [Done].

# Source/application

## Supported source and application

You can play or use the following sources or application with this product.

- HD Radio™ Technology (page 48)
- Playing data in a USB (page 66)

The following sources or applications can be played back or used by connecting an auxiliary device.

- Bluetooth audio (page 46)
- SiriusXM® Satellite Radio (page 52)
- Using external devices (AUX) (page 72)
- Car Sources (iDataLink® (page 58))
- Car Features (iDataLink® (page 58) or Metra Axxess (page 63))
- Displaying video images from the back camera/2nd camera (page 74)



## Displaying the source/application list screen

- 1 Touch  then [Sources].

The source/application screen appears.

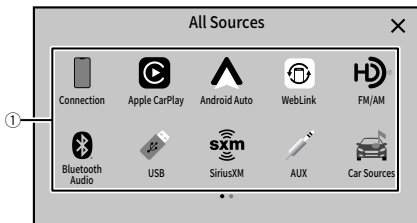
You can display the hidden source icons by swiping left on the screen.





①	<p><b>Source list</b> Touch to see the selected source.</p> <p><b>TIP</b> Selecting [Power OFF] will turn off most of the functions on this unit. The [Power OFF] mode is released in the following cases:</p> <ul style="list-style-type: none"> <li>• Footage from the rear view camera is input when the vehicle is in reverse.</li> <li>• A button on this unit is touched.</li> <li>• The ignition switch is turned off (ACC OFF), then turned on (ACC ON).</li> </ul>
	<b>Displays the next items in the list if there are more.</b>
	<b>Displays the previous screen.</b>

## Displaying the AV operation screen

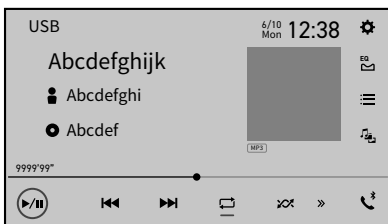
- 1 Touch  and then touch the Source list key.  
The AV operation screen appears.



	<p><b>Settings (page 78) and Favorite menu (page 78)</b> A badge is displayed when information about the latest firmware update is received, or when there is no linkage with PxLink app (page 87) (page 96).</p>
	<b>Selects or customizes the equalizer curve (page 93).</b>
	<b>Hands-free phoning (page 41)</b>

## Selecting a source/an application

[Source OFF] is only available for AV sources.

### Source/application selection screen

- 1 Touch  then [Sources].
- 2 Touch the source/application icon.  
When you select [Source OFF], the AV source is turned off.

# Apple CarPlay

You can operate iPhone applications with finger gestures such as tapping, dragging, scrolling, or flicking on the screen of this product.

- The compatible finger gestures vary depending on the application for the iPhone.
- To use the Apple CarPlay function, first turn off the WebLink function.
- Certain uses of the iPhone may not be legal while driving in your jurisdiction, so you must be aware of and obey any such restrictions. If in doubt as to a particular function, only perform it while the car is parked. No feature should be used unless it is safe to do so under the driving conditions you are experiencing.

## Compatible iPhone models

For details about compatibility of iPhone models, refer to the following website.  
<https://www.apple.com/ios/carplay>

## Connecting your iPhone

When connecting an iPhone to this product, the settings are automatically configured according to the device to be connected. For details of the compatibility, refer to Compatible iPhone models (page 101).

### Wired connection

- For USB connection, refer to the Quick start guide.

- 1 Connect an Apple CarPlay compatible device to this product via USB.
- 2 Touch .
- 3 Touch [Apple CarPlay].

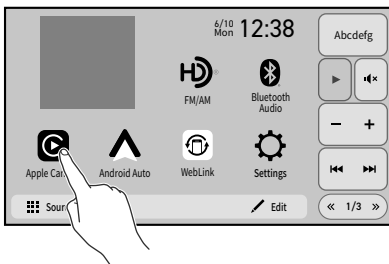

The playback screen appears.

## Wireless connection

- 1 Connect an Apple CarPlay compatible device to this product wirelessly (page 31).
- 2 Touch .
- 3 Touch [Apple CarPlay].

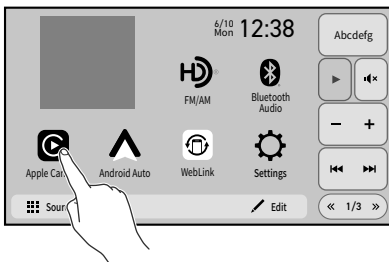

The playback screen appears.

## Using Apple CarPlay

Apple CarPlay may not be available in your country or region.



For details about Apple CarPlay, visit the following site:

<https://www.apple.com/ios/carplay>

- The content and functionality of the supported applications are the responsibility of the App providers.
- In Apple CarPlay, usage is limited while driving, with availability of functions and content determined by the App providers.
- Apple CarPlay allows access to applications other than those listed that are subject to limitations while driving.
- PIONEER IS NOT RESPONSIBLE AND DISCLAIMS LIABILITY FOR THIRD PARTY (NON-PIONEER) APPS AND CONTENT, INCLUDING WITHOUT LIMITATION ANY INACCURACIES OR INCOMPLETE INFORMATION.
- Before using Apple CarPlay, make sure the GPS antenna and speed cable are properly connected and installed, and the unit angle is properly set. For details on the installation, refer to the Quick start guide.
- The accuracy of the directions by Apple CarPlay depends on the application.

## Setting the driving position

To achieve optimum usability of Apple CarPlay, set the driving position setting correctly according to the vehicle. The setting will be applied the next time an Apple CarPlay compatible device is connected to this product.

- 1 Touch  .
- 2 Touch  then  .  
The communication setting screen appears.
- 3 Touch [Driving Position] then select the item.
  - [Left]  
Select for a left-hand drive vehicle.
  - [Right]  
Select for a right-hand drive vehicle.

## Starting procedure

### Wired connection

- 1 Touch the Apple CarPlay icon.  
The Apple CarPlay home screen appears.

#### TIP

You can also start Apple CarPlay from the source/application list screen by touching [Sources] on the home menu screen.

### Wireless connection

- Before using Apple CarPlay wirelessly, perform the following:
  - Attach the GPS antenna to this product.
  - Turn on Apple CarPlay in the setting menu of your iPhone.
- When the device for Apple CarPlay is connected to this unit, the device is also connected via Bluetooth at the same time. If five devices are already paired, the message confirming whether to delete the registered device is displayed. If you want to delete the device, touch [Agree]. If you want to delete other device, touch [Go to DeviceList] and delete the devices manually on the mobile device select screen.
- If an Apple CarPlay compatible device has been connected and another screen is displayed, touch Apple CarPlay icon on the source/application screen to display the Application menu screen.
- The Bluetooth connection with the Apple CarPlay compatible device will be terminated automatically if Apple CarPlay is turned on. While Apple CarPlay is turned

on, only a Bluetooth audio connection will be possible for devices other than the device connected via Apple CarPlay.

- Hands-free phoning via Bluetooth wireless technology is not available while Apple CarPlay is on. If Apple CarPlay is turned on during a call on a cellular phone other than an Apple CarPlay compatible device, the Bluetooth connection will be terminated after the call ends.

#### NOTE

To use a wireless connection, you must set [Access point] to [On] (page 23).

- 1 Turn on the Wi-Fi function and the Bluetooth function on the device.**
- 2 Display the Bluetooth setting menu on the device.**
- 3 Touch .**
- 4 Touch the Apple CarPlay icon.**  
The device search screen appears.

#### NOTE

You can also display the device search screen by touching and holding .

- 5 Touch  if the device that you want to connect does not appear.**  
The available devices appear on the list.
- 6 Touch the desired device on the screen.**  
You can also start Apple CarPlay with the desired device by opening the Bluetooth or Apple CarPlay setting menu while displaying the device search or device list screen.
- 7 Touch [Yes] to pair with the device.**
- 8 Perform the pairing operation by operating the device.**  
The unit configures the connection then starts the application.

#### ►How can Siri help?

You can use the Siri function by touching the  button once Apple CarPlay is activated.

## Adjusting the volume

You can adjust the enhanced Siri (if available on your device) or guidance volume separately from the main sound volume when Apple CarPlay is used.

- 1 While Apple CarPlay is activated, press VOL (+/-).**  
The volume menu will be displayed on the screen.  
The volume menu is displayed for four seconds. If the menu disappears, press **VOL (+/-)** again. The menu reappears.

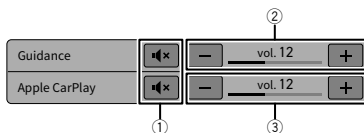

①	<b>Touch to mute. Touch again to cancel mute.</b> The mute function is not available while the enhanced Siri function is used.
②	<b>Touch [+] / [-] to adjust the guidance volume.</b>
③	<b>Displays the main sound volume. To adjust the main sound volume, press VOL (+/-) on the unit or touch [+] / [-].</b>

## Using shortcuts

You can display the screen of Apple CarPlay and of the unit at the same time on one screen if the split screen function is available on your iPhone.

This function is useful such as when you want to operate the radio source while displaying the map screen.

- The screen positions of the Apple CarPlay and of the unit depend on the [Driving Position] setting (page 31).

**1** Touch  to switch to the split screen view.

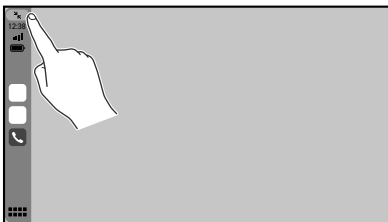

Touch  if you want to return to the full screen.

# Android Auto™

You can operate Android applications with finger gestures such as tapping, dragging, scrolling, or flicking on the screen of this product.

- The compatible finger gestures vary depending on the application for the smartphone.

## Compatible Android devices

For details about compatibility of Android models, refer to the following website.  
<https://support.google.com/androidauto>

## For wireless connections

Compatible Android phone and compatible active data plan required.

### **WARNING**

Certain uses of the smartphone may not be legal while driving in your jurisdiction, so you must be aware of and obey any such restrictions. If in doubt as to a particular function, only perform it while the car is parked. No feature should be used unless it is safe to do so under the driving conditions you are experiencing.

## Connecting your Android device

### Wired connection

- For USB connection, refer to the Quick start guide.

- 1** Connect an Android Auto compatible device to this product via USB.
- 2** Touch .

### 3 Touch [Android Auto].

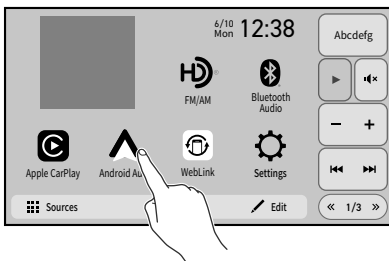

The playback screen appears.

## Wireless connection

- 1 Connect an Android Auto compatible device to this product wirelessly (page 36).
- 2 Touch .
- 3 Touch [Android Auto].

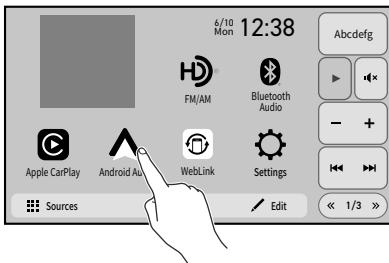

The playback screen appears.

## Using Android Auto

Android Auto may not be available in your country or region.  
For details about Android Auto, please refer to the Google support site:

<https://support.google.com/androidauto>

- The content and functionality of the supported applications are the responsibility of the App providers.
- In Android Auto, usage is limited while driving, with availability of functions and content determined by the App providers.
- Android Auto allows access to applications other than those listed that are subject to limitations while driving.
- PIONEER IS NOT RESPONSIBLE AND DISCLAIMS LIABILITY FOR THIRD PARTY (NON-PIONEER) APPS AND CONTENT, INCLUDING WITHOUT LIMITATION ANY INACCURACIES OR INCOMPLETE INFORMATION.
- Before using Android Auto, make sure the GPS antenna and speed cable are properly connected and installed, and the unit angle is properly set. For details on the installation, refer to the Quick start guide.
- The accuracy of the directions by Android Auto depends on the application.



## Starting procedure

### Wired connection

- 1** Connect an Android Auto compatible device to this product via USB.
- 2** Touch the Android Auto icon.  
The Android Auto home screen appears.

### Wireless connection

To use a wireless connection, you must set [Access point] to [On] (page 23).

- 1** Turn on the Wi-Fi function.
- 2** Display the connected Bluetooth devices list screen on the device.
- 3** Touch .
- 4** Touch the Android Auto icon then [Start] to display the device search screen.  
The device search screen appears.  
You can also display the device search screen by touching and holding .
- 5** Touch  if the device that you want to connect does not appear.  
The available devices appear on the list.
- 6** Touch the desired device on the screen.
- 7** Touch [Yes] to pair with the device.
- 8** Perform the pairing operation by operating the device.  
The unit configures the connection then starts the application.

## ► How can the voice recognition function help?

You can use the voice recognition function by touching the  button once Android Auto is activated.

### NOTES

- For details on USB connection, refer to the Quick start guide.
- When the device for Android Auto is connected to this unit, the device is also connected via Bluetooth at the same time. If five devices are already paired, the message confirming whether to delete the registered device is displayed. If you want to delete the device, touch [Agree]. If you want to delete other device, touch [Go to DeviceList] and delete the devices manually on the mobile device select screen.
- If Android Auto is turned on during a call on a cellular phone other than the Android Auto compatible device, the Bluetooth connection will switch to the Android Auto compatible device after the call.

## Adjusting the volume

You can adjust the voice recognition or guidance volume separately from the main sound volume when Android Auto is used.

### 1 While Android Auto is activated, press VOL (+/-).

The volume menu will be displayed on the screen.

The volume menu is displayed for four seconds. If the menu disappears, press **VOL (+/-)** again. The menu reappears.

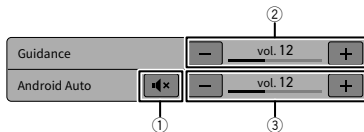

①	<b>Touch to mute. Touch again to cancel mute.</b>
②	<b>Touch [+] / [-] to adjust the guidance volume.</b>
③	<b>Displays the main sound volume. To adjust the main sound volume, press VOL (+/-) on the unit or touch [+] / [-].</b>

## Setting the auto-launch function

If this function is set to on, the Android Auto screen is displayed automatically when an Android Auto compatible device is connected to this unit.

- The Android Auto screen is displayed automatically only when an Android Auto compatible device is correctly connected to this product.

- 1 Touch .
- 2 Touch  then .
- 3 Touch [Android Auto Auto-launch] to switch [On] or [Off].

# WebLink®

You can operate WebLink® compatible applications with finger gestures such as tapping, dragging, scrolling, or flicking on the screen of this product.

- The supported finger gestures may vary depending on the WebLink® compatible application.
- To use WebLink®, you must first install the WebLink Host app on the iPhone or smartphone. For details about the WebLink® Host app, visit the following site: <http://hellowebblink.com/>
- Be sure to read Using app-based connected content (page 122) before you perform this operation.
- Copyright protected files such as DRM cannot be played.
- Certain uses of the iPhone or smartphone may not be legal while driving in your jurisdiction, so you must be aware of and obey any such restrictions. If in doubt as to a particular function, only perform it while the car is parked. No feature should be used unless it is safe to do so under the driving conditions you are experiencing.

## Using WebLink®

### Important

- Pioneer is not responsible for content or functions accessed via WebLink®, which are the responsibility of the application and content providers.
- Availability of non-Pioneer content and services, including apps and connectivity, may change or discontinue without notice.
- For the latest OS support information, please visit [HelloWebLink.com](http://HelloWebLink.com).
- When using WebLink® with the Pioneer product, available content and functions will be limited while driving.

## Starting procedure

### For iPhone users

#### System requirement

For the latest OS support information, please visit [HelloWebLink.com](http://HelloWebLink.com).

- 1 **Unlock your iPhone and connect it to this product via USB.**
- 2 Touch .

### 3 Touch [WebLink].

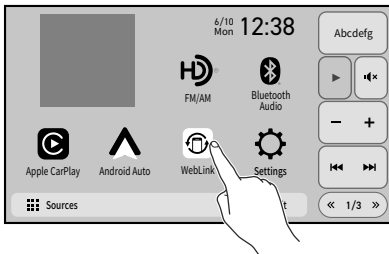

#### For smartphone (Android) users

##### System requirement

- For the latest OS support information, please visit [HelloWebLink.com](http://HelloWebLink.com).
- The video playback capability depends on the connected Android device.
- For USB connection, refer to the Quick start guide.
- Make sure that file transfer mode for USB connection is enabled on your smartphone if WebLink® does not start automatically.

**1** Unlock your smartphone and connect it to this product via USB.

**2** Touch .

**3** Touch [WebLink].

## Basic operation

Touch the desired application icon after the WebLink® app is launched. The desired application is launched, and the application operation screen appears.

- Check the Bluetooth connection between the mobile device and this unit if there is no sound output from this unit (page 20).



##### Displays the main menu of the WebLink® source screen.

- If you connect your device to this product while a WebLink® compatible application is already running, the application operation screen will appear on this product.

# Hands-free phoning

To use this function, you need to connect your cellular phone to this product via Bluetooth in advance (page 20).

## Making a phone call

- 1 Touch  then [Sources].
- 2 Touch [Phone].  
The phone menu screen appears.
- 3 Touch one of the call icons on the phone menu screen.

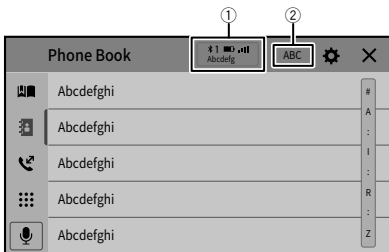

①

**The following items are displayed.**

- Name of the current cellular phone
- List number of the current cellular phone
- Reception status of the current cellular phone
- Battery status of the current cellular phone

**TIP**

If you connect two cellular phones to this product at the same time, you can switch between the cellular phones using the switch devices key.







②

**Switches the search language to English or system language.**

It may not appear depending on the system language setting.



**Using the preset dial lists (page 42)**

	<p><b>Using phone book</b></p> <p>Select a contact from the phone book. Touch the desired name on the list then select the phone number.</p> <ul style="list-style-type: none"> <li>• The contacts on your phone will be automatically transferred to this product.</li> <li>• Update the phone book manually.</li> <li>• [Visibility] of the [Bluetooth settings] screen should be on (page 21).</li> <li>• If two cellular phones are automatically connected to this product with the Bluetooth device auto connect function, the phone book of the first phone is displayed.</li> </ul>
	<p><b>Using call history</b></p> <p>Make a phone call from the received call , dialed call , or missed call .</p>
	<p><b>Direct phone number input</b></p> <p>Touch the number keys to enter the phone number then touch  to make a call.</p>





### To end the call

- 1 Touch .



## Using the preset dial lists

### Registering a phone number



You can easily store up to six phone numbers per device as presets.

- 1 Touch  then [Sources].
  - 2 Touch [Phone].
  - 3 Touch  or .
- On the [Phone Book] screen, touch the desired name to display the contact's phone number.
- 4 Touch .





### Dialing from the preset dial list

- 1 Touch  then [Sources].
- 2 Touch [Phone].
- 3 Touch .
- 4 Touch the desired entry on the list to make a call.  
The dial screen appears and dialing starts.

## Deleting a phone number

- 1 Touch  then [Sources].
- 2 Touch [Phone].
- 3 Touch .
- 4 Touch .
- 5 Touch [Yes].

## Receiving a phone call

- 1 Touch  to answer the call.  
Touch  to end the call.
  - Touch  while receiving an Incoming Call to put current call on hold and accept new call.
  - Touch  while receiving an Incoming Call to decline the call.

### NOTE

When two phones are connected at the same time, if an incoming call is received on the second phone while you are talking on the first phone, the Incoming Call Screen for the second phone will be displayed.

## Voice recognition function (for iPhone)

By connecting your iPhone to this product, you can use the voice recognition function (Siri Eyes Free Mode) on this product.

- If two cellular phones are automatically connected to this product with the Bluetooth device auto connect function, the voice recognition function (Siri Eyes Free Mode) will be set on the first phone.
- If you want to use the voice recognition function (Siri Eyes Free Mode) on another connected iPhone, touch the numbered  linked to the other iPhone. The iPhone that you switch to will be set as the current device.

### NOTE

When an iPhone is used, Siri Eyes Free Mode is available with this product.

- 1 Touch  then [Sources].
- 2 Touch [Phone].
- 3 Touch .

The voice recognition function launches and the voice control screen appears. You can also launch the voice recognition function by touching the  button.

## Phone setting



- 1 Touch .
- 2 Touch  then .
- 3 Touch [Bluetooth settings].

Menu Item	Description
[Auto Answer] [On] [Off]	Select [On] to answer an incoming call automatically.
[Ring Tone] [On] [Off]	Select [Off] to use the ring tone of the paired device, or select [On] to use the ring tone of this unit.
[Invert Name]	Select [Yes] to change the order of the first and last names in the phone book.

## Setting the private mode

During a conversation, you can switch to private mode (talk directly on your cellular phone).

- If two cellular phones are connected to this product and the first phone is set to private mode, you can receive incoming calls on the second phone while maintaining the call in progress on the first phone.
- When two cellular phones are connected to this product and private mode of the first phone is turned off, if an incoming call on the second phone is answered while a call is in progress on the first phone or while dialing or receiving a call on the first phone, the call, dialing, or receiving on the first phone is ended.

- 1 Touch  or  to turn private mode on or off.

## Adjusting the other party's listening volume

This product can be adjusted to the other party's listening volume.

- 1 Touch  to switch between the three volume levels.

## Notes for hands-free phoning

### General notes

- Connection to all cellular phones featuring Bluetooth wireless technology is not guaranteed.

- The line-of-sight distance between this product and your cellular phone must be 10 meters or less when sending and receiving voice and data via Bluetooth technology.
- With some cellular phones, the ring sound may not be output from the speakers.
- If private mode is selected on the cellular phone, hands-free phoning may be disabled.

### Registration and connection

- Cellular phone operations vary depending on the type of cellular phone. Refer to the instruction manual that came with your cellular phone for detailed instructions.
- When phone book transfer does not work, disconnect your phone and then perform pairing again from your phone to this product.

### Making and receiving calls

- You may hear a noise in the following situations:
  - When you answer the phone using the button on the phone.
  - When the person on the other end of the line hangs up the phone.
- If the person on the other end of the line cannot hear the conversation due to an echo, decrease the volume level for hands-free phoning.
- With some cellular phones, even after you press the accept button on the cellular phone when a call comes in, hands-free phoning may not be performed.
- The registered name will appear if the phone number is already registered in the phone book. When multiple names are registered for the same phone number, the names are displayed in the same order as in the phone book.

### The received call and dialed number histories

- You cannot make a call to the entry of an unknown user (no phone number) in the received call history.

### Phone book transfers

- If there are more than 1 000 phone book entries on your cellular phone, not all entries may download completely.
- Depending on the phone, this product may not display the phone book correctly.
- If the phone book in the phone contains image data, the phone book may not be transferred correctly.
- Depending on the cellular phone, phone book transfer may not be available.

# Bluetooth audio

Before using the Bluetooth audio player, register and connect the device to this product (page 20).

- Depending on the Bluetooth device connected to this product, the available operations with this product may be limited or differ from the descriptions in this manual.
- While you are listening to songs on your Bluetooth device, refrain from operating the phone function as much as possible. If you try operating, the signal may cause noise for song playback.
- When you are talking on the Bluetooth device connected to this product via Bluetooth, it may pause playback.

## NOTE





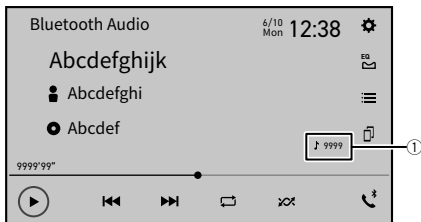

Depending on the Bluetooth audio player connected to this product, the available operations with this product may be limited to the following two levels:

- A2DP (Advanced Audio Distribution Profile): Only playing back songs on your audio player is possible.
- A2DP and AVRCP (Audio/Video Remote Control Profile): Playing back, pausing, selecting songs, etc., are possible.

- 1 Touch  then [Sources].**  
The source/application screen appears.
- 2 Touch [Bluetooth Audio].**  
The Bluetooth audio playback screen appears.

## Basic operation



	<b>Track number indicator</b>
	<b>Switches between playback and pause.</b>
	<b>Skips files forward or backward.</b>
	<b>Sets a repeat play range.</b>
	<b>Switches between random and normal file playback order.</b>
	<b>Selects a file or folder from the list to playback.</b> <b>NOTE</b> This function is available only when the AVRCP version of the Bluetooth device is 1.4 or higher.
	<b>Switches among the Bluetooth devices when the devices are connected to this product via Bluetooth (page 21).</b>

# HD Radio™ Technology

## About HD Radio stations

HD Radio stations offer high quality audio and data services. HD Radio stations are brought to you by your local FM or AM stations.

HD Radio stations feature the following:

- High quality audio
- FM multicasting
- Data service

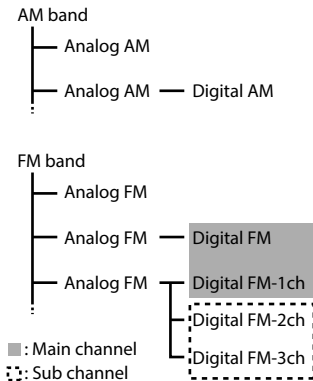

Digital Sound

Digital, CD-quality sound. HD Radio Technology enables local radio stations to broadcast a clean digital signal. AM sounds like today's FM and FM sounds like a CD.

Program Info

Program Info: Contributes to the superior user experience of HD Radio Technology. Presents song name, artist, station IDs, HD2/HD3 Channel Guide, and other relevant data streams.

## HD2/HD3

Adjacent to traditional main stations are extra local FM channels. These HD2/HD3 Channels provide new, original music as well as deep cuts into traditional genre.

## Artist Experience











Visual information related to content being played on your HD Radio receiver, such as Album Art, historical photographs, still art from live broadcasts, among other related content.

### Starting procedure

- 1 Touch  then [Sources].
- 2 Touch [FM/AM].  
The radio screen appears.

### Basic operation



	 <b>Recalls the preset channel stored to a key from memory.</b>
	 <b>Stores the current broadcast frequency to a key.</b>
	<b>Displays the preset channel list.</b> Select an item on the list ([1] to [6]) to switch to the preset channel.
	<b>Selects the FM1, FM2, FM3 or AM band.</b>
	 <b>Performs BSM (best stations memory) function (page 50).</b>
	 <b>Manual tuning</b>
	 <b>Seek tuning or non stop seek tuning</b> Releasing the key in a few seconds skips to the nearest station from the current frequency. Keep holding the key for long seconds to perform non stop seek tuning.
	<b>Switches the text display between the main channel and sub channels.</b>

## Storing the strongest broadcast frequencies (BSM)

The BSM (best stations memory) function automatically stores the six strongest broadcast frequencies under the preset channel keys [1] to [6].

- Storing broadcast frequencies with BSM may replace those you have already saved.
- Previously stored broadcast frequencies may remain stored if the number of frequencies stored has not reached the limit.



### 1 Touch and hold to begin search.

The six strongest broadcast frequencies will be stored under the preset channel keys in the order of their signal strength.

### To cancel the storage process

#### 1 Touch [Cancel].

## Radio settings

- 1 Touch .
- 2 Touch  then .
- 3 Touch [AV Source settings].
- 4 Touch [Radio settings].

Menu Item	Description
<b>[Blending]</b> [On] [Off]	Switches to the analog broadcast of the same frequency level automatically when reception of a digital broadcast becomes weak. Select [Off] to receive only an analog signal.
<b>[Seek]</b>	Select the method of seek tuning.
[Seek All]	Seeks stations from both analog and digital broadcasting.
[Seek HD]	Only seeks stations from digital broadcasting.
<b>[Local]</b> [Off] <b>FM:</b> [Level1] [Level2] [Level3] [Level4] <b>AM:</b> [Level1] [Level2]	Local seek tuning allows you to only tune into radio stations with sufficiently strong signals. <ul style="list-style-type: none"><li>• The FM [Level4] (AM [Level2]) setting allows reception of only stations with the strongest signals.</li><li>• This setting is available only when [FM/AM] is selected as the source.</li></ul>

# SiriusXM<sup>®</sup> Satellite Radio

SiriusXM is where moments happen. The widest, deepest variety of music, ad-free. More games, more sports, more coverage than anywhere. The most extensive entertainment, complete news coverage and every kind of comedy. Listen in your car, on your phone, online and at home. A SiriusXM Vehicle Tuner and subscription are required. For more information, visit [www.siriusxm.com](http://www.siriusxm.com)

To take full advantage of all the SiriusXM capabilities, such as TuneMix™, please use the SXV300 tuner or one of the newer SiriusXM tuners (sold separately). Other tuners are compatible but may limit the features.

## Subscribing to the SiriusXM Satellite Radio service

**1** Touch  then [Sources].

**2** Touch [SiriusXM].

You should be able to tune in to Channel 1. If you cannot get Channel 1, ensure that your SiriusXM Connect Vehicle Tuner is installed correctly.

**3** Switch to Channel 0 and check the Radio ID.

The SiriusXM Radio ID can be found by tuning in to Channel 0. In addition, the Radio ID is located on the bottom of the SiriusXM Connect Vehicle Tuner and its packaging. You will need this number to activate your subscription.

### NOTE

The SiriusXM Radio ID does not include the letters I, O, S, or F.

**4** Activate the service either online or by phone.

### TIP

In the USA, you can activate online or by calling SiriusXM Listener care:

- Visit [www.siriusxm.com/activatenow](http://www.siriusxm.com/activatenow)
- Call SiriusXM Listener Care at 1-866-635-2349

For Canadian Subscriptions, please contact:

- Visit [www.siriusxm.ca/activate](http://www.siriusxm.ca/activate)
- Call SiriusXM Customer Care at 1-888-539-7474

### NOTES

- The SiriusXM satellites will send an activation message to your tuner. When the tuner has received the message, [Subscription Updated Press Enter to Continue] is displayed.
- The activation process usually takes 10 to 15 minutes, but it may take up to an hour. Do not turn off this product while the activation message is displayed.

## Listening to SiriusXM







- 1 Touch  then [Sources].
- 2 Touch [SiriusXM].

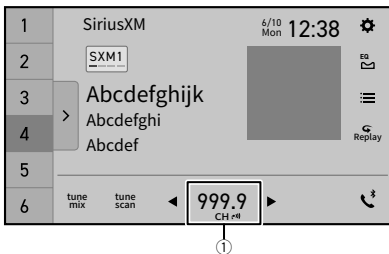







## Basic operation

- On the Featured Favorites™ Band, the current broadcast frequency cannot be stored to a key (page 56).
- If fewer than two music channels are stored as presets, you cannot use the TuneMix function.
- [RADIO ID] is displayed when Channel 0 is selected.

### Current channel display (Live broadcast mode)





	<b>Selects a channel directly.</b>
	 <b>Recalls the preset channel stored to a key from the memory.</b>
	 <b>Stores the current channel to a key.</b>
	<b>Displays the preset channel list.</b> Select an item on the list ([1] to [6]) to switch to the preset channel.
	<b>Selects a band.</b> There are 3 bands and a Featured Favorites. You can store 6 channels per band for a total of 18 presets.

tune mix	<p><b>Switches TuneMix to on or off.</b></p> <p>You can use TuneMix from each of the music channels stored as presets on the current band.</p> <ul style="list-style-type: none"> <li>When fewer than two music channels are stored as presets, you cannot use TuneMix.</li> <li>Locked channels will not be used by TuneMix until the channels are unlocked by entering the parental control passcode.</li> </ul>
tune scan	<p><b>Performs TuneScan™ (page 55).</b></p>
	<p> <b>Performs channel number up/down.</b></p>
	<p> <b>Performs fast channel number up/down.</b></p>
	<p><b>Switches to Replay Mode.</b></p>
	<p><b>Selects a channel from the list.</b></p> <p>Select the category name or the list of all channels then touch the desired channel. To switch the display list, touch .</p> <ul style="list-style-type: none"> <li>The displayed list switches in the following order. Channel Name—Artist Name—Song Title—Content Info</li> <li>If you touch , you can scan each channel in the selected category.</li> <li>When there is no category, you can select the channel from [Others].</li> <li>The types of categories available depend on the types of channels available.</li> <li>It may take time to display the channel list depending on the SiriusXM reception condition.</li> </ul>

## Replay Mode (Time bar display)



	<p><b>Switches between playback and pause.</b></p>
	<p> <b>Performs content forward or backward.</b></p>

**Performs fast forward or rewind.**

The operation stops if the icon is touched and held for more than 30 seconds. To resume the operation, touch and hold the icon again.

**Switches to live broadcast mode.**

## TuneScan

When you activate the TuneScan feature, you will hear a few seconds of the songs which have not been listened to from each of the music channels stored as presets on the current band.

- When fewer than two music channels are stored as presets, you cannot use TuneScan.
- TuneScan may take a few minutes to become available after the product is turned on or the preset band is changed.

**1** Touch  to display the following display.

**Continues playing the current scanning song or channel.****Skips to the previous/next song during TuneScan or to the previous/next channel during category scan.****Cancels scan play and returns to the previous channel.**

## SmartFavorites

All preset channels will buffer the content to be used for Replay, TuneStart™, TuneScan and TuneMix features.

## Using Featured Favorites Band

Featured Favorites are groups of channels that are created by the SiriusXM Programming department allowing you to discover new channels. Featured Favorite channels are dynamic and can change often, allowing you to discover new channels. For details, see [Featured Favorites] (page 57) and [Featured Band Update Message] (page 57) in SiriusXM settings.

### How to access

When there is a Featured Favorite, access it with the band key.

**1 Touch the band key.**



SXM1—SXM2—SXM3—Featured

When there are multiple Featured Favorites, access them from the category list. It is displayed at the bottom of the category list (page 54).

## Parental lock





The Parental Control feature allows you to limit access to any SiriusXM channels, including those with mature content. When enabled, the Parental Control feature requires you to enter a passcode to tune to the locked channels. For details, see [Parental Control] (page 57) in SiriusXM settings.

## SiriusXM settings

- 1** Touch .
- 2** Touch  then .
- 3** Touch [AV Source settings].
- 4** Touch [SiriusXM settings].

The menu items vary depending on whether SiriusXM is selected as the source.

Menu Item	Description
[Tune Start] [On] [Off]	Start songs automatically from the beginning when you tune to one of your preset channels in the current preset band when TuneStart is turned on.

Menu Item	Description
<b>[Parental Control]</b>	<p>Enter the current passcode then touch  to set this function (the default passcode is 0000).</p> <ul style="list-style-type: none"> <li>• To edit the passcode, touch [Edit Code] then touch  followed by entering the new passcode.</li> <li>• To lock the channel, touch the appropriate channel.  appears and the channel is locked.</li> <li>• When you touch the locked channel, the channel is unlocked.</li> <li>• When you touch [Clear All], all locked channels are unlocked.</li> </ul>
<b>[Featured Favorites]</b> [On] [Off]	<p>Set to [On] to allow you to discover new channels created by the SiriusXM Programming department.</p> <ul style="list-style-type: none"> <li>• When [Featured Band Update Messages] is set to [On] and the Featured Favorite Band is updated, the Featured Band Update message will appear.</li> </ul>
<b>[Featured Band Update Message]</b> [On] [Off]	<p>Set to [On] to be notified when the featured seasonal theme is updated.</p> <ul style="list-style-type: none"> <li>• To display [Featured Band Update Messages] at all times, [Featured Favorites] needs to be set to [On].</li> </ul>
<b>[SiriusXM Reset]</b>	<p>Set to restore to the default SiriusXM settings by touching [Restore].</p> <ul style="list-style-type: none"> <li>• The source is turned off before the process starts.</li> </ul> <p> <b>CAUTION</b> Do not turn off the engine while restoring the settings.</p>

# iDatalink<sup>®</sup>

## Using iDatalink

You can access the satellite radio source provided for the vehicle. The vehicle information and many OEM systems such as steering wheel controls, warning chimes, driver safety systems, and etc. can be displayed on this product by connecting the optional iDatalink adaptor. It is also possible to add visual screens such as gauges, vehicle information, climate control, and parking assist. However, an extra interface module is required to access these features.

- The operating buttons, text information, etc. overlaid on the camera view screen may not appear immediately after turning on the ignition switch.

### NOTE

Since the type of module varies depending on the vehicle model, search for your vehicle via the following URL to determine which features are available for each module. Remember to select the correct radio model for accurate results.

<https://www.idatalinkmaestro.com/en>

### Important

- For details about vehicle models that are compatible with the iDatalink adaptor, refer to the information on our website.
- After installing the iDatalink adaptor, be sure to check that it operates properly.
- Functions and displays vary depending on the vehicle model. For details on the functions available for each model, refer to the information on our website.
- For troubleshooting information about iDatalink functions, visit the following website: <https://www.idatalinkmaestro.com/en/support/faq>

### Limitations

- The data is transmitted to this product from your vehicle system via the connected iDatalink adaptor. Therefore, the actual data contents displayed on your product may differ from the contents on the screen described in this manual.
- When information on your vehicle or on the devices in your vehicle is sent from the iDatalink<sup>®</sup> Maestro<sup>®</sup> module, a screen notifying you of such information may pop up.

## Activating iDatalink Maestro

Before using and/or connecting the iDatalink Maestro adaptor, you will need to first flash the Maestro RR module with the appropriate vehicle and head unit firmware.

- For details on installing the firmware, refer to iDatalink Maestro website.
- For details on connecting this product to iDatalink Maestro, refer to the Quick start guide.

- You can also check the device number on the [Firmware Information] screen of this product (page 86).

- 1 Find the device number (12 alphanumeric characters) on the label on the packaging of this product or on the product itself.**
- 2 Access the following website and follow the on-screen instructions to configure the desired firmware.**  
<https://www.idatalinkmaestro.com/en>





**NOTE**

When the serial number input is required, input the device number of this product.

- 3 Install the vehicle/head unit-specific firmware on your iDatalink Maestro module.**
- 4 Connect this product to the iDatalink Maestro and install this product to the vehicle.**  
 The iDatalink function will be active.

## Starting procedure

The iDatalink function is available only when the input signal is received by the iDatalink Maestro adaptor.

- 1 Connect the iDatalink Maestro adaptor to this product.**  
 For details, refer to the Quick start guide.
- 2 Touch .**
- 3 Touch  then .**
- 4 Touch [Input/Output settings].**
- 5 Touch [AV Input].**
- 6 Confirm that [Maestro] is selected.**
- 7 Touch  then [Sources].**
- 8 Touch [Car Sources] or [Car Features].**  
 The menu screen you touched appears.

### Using the functions on [Car Sources]







[Car Sources] is operated almost the same way as the built-in AV sources on this product is operated. For details on the operation, refer to the following relevant pages.

- Operating via USB/iPhone (page 66) (page 29)
- Operating via SiriusXM (page 52)

- Operating via Bluetooth audio (page 46)
- Operating via Hands-free phone (page 41)

## Using the functions on [Car Features]

You can check and use the following screens after selecting [Car Features] in the starting procedure. Touch one of the icons on the left side of the screen to change a feature.

	<b>Displays the Gauge screen.</b>
	<b>Displays the Vehicle Information screen.</b>
	<b>Displays the Climate screen.</b>
	<b>Displays the Parking Assist screen.</b>
	<b>Displays the Speed Radar Detector screen.</b>
	<b>Displays rear monitor mirroring when the rear monitor is connected via iDataLink.</b>

### Gauges screen

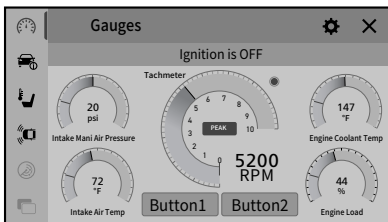

## Vehicle Information screen

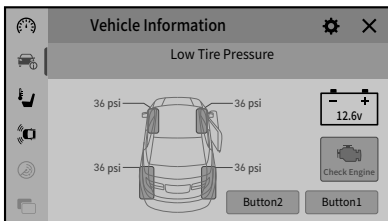

## Climate screen



## Parking Assist screen



## Speed Radar Detector screen





### Displaying obstacle detection information

This function is only available for vehicles equipped with a parking sensor system.

#### **⚠ CAUTION**

This function is intended solely to assist the driver's vision. It does not detect all dangers and obstacles and is not a substitute for your attentiveness, judgement, and care while parking your vehicle.

### iDatalink settings

- 1 Touch .
- 2 Touch  then .
- 3 Touch [OEM settings] or [OEM Volume settings].  
The setting screen for iDatalink appears.

Menu Item	Description
[OEM settings]	Setting for iDatalink function when the iDatalink adaptor is connected to the unit.
[OEM Volume settings]	Setting for iDatalink function volume when the iDatalink adaptor is connected to the unit.

# Metra Axxess

## Using Metra

Access the vehicle information and many of the OEM systems such as climate control, driver safety systems, etc. and display them on this product by replacing the Metra parts kit with interface conversion.

### NOTE

Since the type of module varies depending on the vehicle model, search for your vehicle via the following URL to determine which features are available for each module.

<http://metraonline.com/>



### Important

- For details about vehicle models that are compatible with the Metra interface conversion unit, refer to the information on Metra website.
- After installing the Metra interface conversion unit, be sure to check that it operates properly.
- Functions and displays vary depending on the vehicle model. For details on the functions available for each model, refer to the information on our website.
- For troubleshooting information about the Metra interface conversion functions, visit the following website. <http://www.metraonline.com/contact-us>

### Limitations



- The data is transmitted to this product from your vehicle system via the connected Metra interface conversion unit. Therefore, the actual data contents displayed on your product may differ from the contents on the screen described in this manual.

## Starting procedure

- 1 Connect the Metra interface conversion unit to this product.**  
For details, refer to the Quick start guide.
- 2 Touch  then [Sources].**
- 3 Touch [Car Features].**  
The menu screen appears.

### Using the functions on [Car Features]

You can check and use the following screens after selecting [Car Features] in the starting procedure. Touch one of the icons on the left side of the screen to change a feature.

	Displays the Vehicle Information screen.
	Displays the Climate screen.
	Displays the Radio ID screen.

## Vehicle information screen



## Climate screen

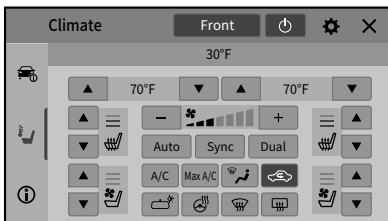

## Radio ID screen

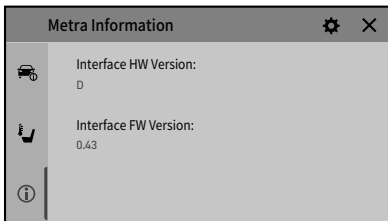

# Playing data in a USB

## Plugging/unplugging a USB storage device

You can play audio, video, or still image files stored in a USB storage device.

### Plugging a USB storage device

- This product may not achieve optimum performance with some USB storage devices.
- Connection via a USB hub is not possible.
- A USB cable is required for connection.

- 1** Pull out the plug from the USB port of the USB cable.
- 2** Plug a USB storage device into the USB cable.

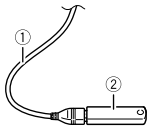

①	USB cable
②	USB storage device (sold separately)

### Unplugging a USB storage device

- 1** Pull out the USB storage device from the USB cable.  
Check that no data is being accessed before pulling out the USB storage device.
- 2** Turn off (ACC OFF) the ignition switch before unplugging the USB storage device.

## Starting procedure

- 1** Plug the USB storage device into the USB cable.
- 2** Touch  then [Sources].
- 3** Touch [USB].

Playback is performed in order of folder numbers. Folders are skipped if they contain no playable files.





## Basic operation

You can set the screen size for the video and image files (page 98).

### Audio source

#### Audio source screen 1



①	<b>Displays the link search screen.</b> Touch the song to play back followed by touching the song information, after switching to Music Browse mode (page 68). This function is available for the USB storage device only.
	<b>Switches between playback and pause.</b>
	<b>Skips files forward or backward.</b>
	<b>Sets a repeat play range for all files/the current folder/the current file.</b>
	<b>Switches between random and normal file playback order.</b>
	<b>Displays the hidden function bar.</b> You can also display the hidden function bar by flicking the bar from the right to the left.

	<p><b>Switches the following media file types.</b></p> <p><b>[Music]:</b> Audio files  <b>[Video]:</b> Video files  <b>[Photo]:</b> Image files</p>
	<p><b>Selects a file from the list.</b></p> <p>Touch a file on the list to playback.          Touching a folder on the list shows its contents. You can play a file on the list by touching it.</p> <p><b>NOTE</b></p> <p>When you play audio files stored in a USB storage device, you can search for a file using Music Browse (page 68).</p>

## Audio source screen 2



	<p><b>Displays the hidden function bar.</b></p> <p>You can also display the hidden function bar by flicking the bar from the left to the right.</p>
	<p><b>Selects the previous folder or the next folder.</b></p>
	<p><b>Constructs the database for using the Music Browse mode (page 68).</b></p>
	<p><b>Switches the current music information display.</b></p>

### ▶ Selecting a file using Music Browse mode

You can select files to play back using the category list if the files contain tag information.

Once the database is created in this unit, there is no need to create the database again as long as the same contents are saved. To enter the Music Browse mode directly, touch and then touch [Tag] before selecting the song.

This function is available for the USB storage device only.

**1 Touch  to create a database.**

Music Browse mode will be available after the database has been created.

**2 Touch .**

**3 Touch the desired category to display the file list.**

**4 Touch the item.**

Refine the item until the desired song title or file name is displayed on the list.

**5 Touch the desired song title or file name to play back.**



If the selection made with Music Browse has been canceled, you can switch to Music Browse mode again by touching the [Tag] tab on the file/folder list screen and touching the desired track.

## Video source

### CAUTION

For safety reasons, video images cannot be viewed while your vehicle is in motion. To view video images, stop in a safe place and apply the parking brake.









①	<p><b>Hides the touch panel keys.</b> To display the keys again, touch anywhere on the screen.</p>
	<p><b>Switches between playback and pause.</b></p>
	<p><b>Performs fast reverse or fast forward.</b> Touch again to change the playback speed.</p>
	<p><b>Stops playback.</b> Touch again to start from the beginning next time.</p>

	<p> <b>Performs frame-by-frame playback.</b></p>
	<p> <b>Performs slow-motion playback.</b></p>
	<p><b>Sets a repeat play range for all files/the current folder/the current file.</b></p>
	<p><b>Switches the audio language.</b></p>
	<p><b>Switches the following media file types.</b>  <b>[Music]:</b> Audio files  <b>[Video]:</b> Video files  <b>[Photo]:</b> Image files</p>
	<p><b>Selects a file from the list.</b>          Touch a file on the list to playback.          Touching a folder on the list shows its contents. You can play a file on the list by touching it.</p>
	<p><b>Skips files forward or backward.</b></p>

## Still image source





①	<p><b>Hides the touch panel keys.</b>          To display the keys again, touch anywhere on the screen.</p>
	<p><b>Switches between playback and pause.</b></p>

	<b>Skips files forward or backward.</b>
	<b>Selects the previous folder or the next folder.</b>
	<b>Rotates the displayed picture 90° clockwise.</b>
	<b>Sets a repeat play range for all files/the current folder.</b>
	<b>Switches between random and normal playback order of the files that are currently selected for repeat playback.</b>
	<b>Switches the following media file types.</b> <b>[Music]:</b> Audio files <b>[Video]:</b> Video files <b>[Photo]:</b> Image files
	<b>Selects a file from the list.</b> Touch a file on the list to playback. Touching a folder on the list shows its contents. You can play a file on the list by touching it.

## USB settings

This setting can be used only when the media format to play is [Photo].

- 1 Touch .
- 2 Touch  then .  
The system setting screen appears.
- 3 Touch [AV Source settings].
- 4 Touch [USB settings].

Menu Item	Description
<b>[Time Per Photo Slide]</b> [5sec] [10sec] [15sec] [Manual]	Select the interval of image file slideshows on this product.

# Using external devices (AUX)





You can display the video image output by the device connected to video input.

- A Mini-jack AV cable (sold separately) is required for connection. For details, refer to the Quick start guide.

## CAUTION

For safety reasons, video images cannot be viewed while your vehicle is in motion. To view video images, stop in a safe place and apply the parking brake.

## Starting procedure

- 1 Touch .
- 2 Touch  then .
- 3 Touch [Input/Output settings].
- 4 Confirm that [AUX Input] is turned on.
- 5 Touch  then [Sources].
- 6 Touch [AUX].  
The AUX screen appears.

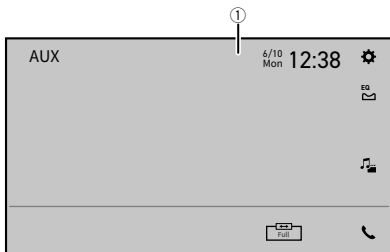

①

**Hides the touch panel keys.**

- To display the keys again, touch anywhere on the screen.
- You can set the screen size for the video image (page 98).



**Switches between the video input and audio input.**





# Displaying video images from the back camera/2nd camera

You can display the video image output using the device connected to the back camera input or 2nd camera input. For details, refer to the Quick start guide.

## Starting procedure

- 1 Touch  then [Sources].
- 2 Touch [Camera View].  
Video footage is displayed on the screen.

## Displaying 2nd camera view

- 1 Touch .
- 2 Touch  then .
- 3 Touch [Input/Output settings].
- 4 Touch [AV Input] and select [2nd Camera].  
Switch between [OFF], [2nd Camera] and [Maestro] with each touch ([Maestro] is only displayed when connected to the iDatalink adaptor).
- 5 Touch  then [Sources].
- 6 Touch [Camera View].

- 7 Touch  to switch the camera view.

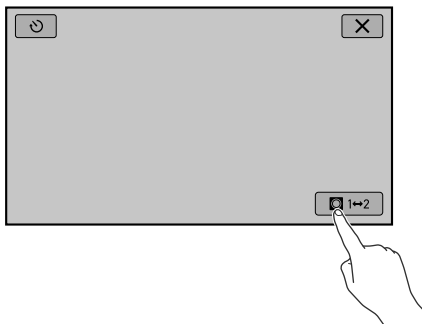

The 2nd camera video footage is displayed on the screen.

**NOTE**



If you touch , the previous screen temporarily appears and the rear view mode resumes after 7 seconds. (If you switch to another screen, the rear view mode may not resume depending on the screen, such as in the case of menu screens.)

# Updating the firmware wirelessly

To update the firmware wirelessly, PxLink app must be installed in advance. You can only update the firmware when the vehicle is stopped and the parking brake is engaged.

## ⚠ CAUTION

- Never turn this product or your iPhone/smartphone off while the firmware is being updated.
- You cannot update the old firmware version once the latest firmware is updated.

- 1 Download the firmware update files into your iPhone or smartphone through PxLink app.
- 2 Operate PxLink app to perform a Bluetooth connection, Bluetooth LE connection, and Wi-Fi connection (page 18).
- 3 Touch .
- 4 Touch  then .
- 5 Touch [System Information].
- 6 Touch [Firmware Update].

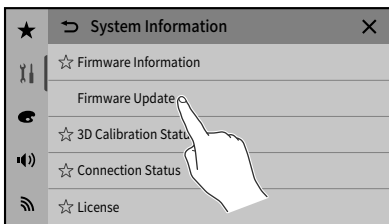

- 7 Touch [Yes].  
Follow the on-screen instructions to finish updating the firmware.
  - This product will reset automatically after the firmware update is completed if the update is successful.

- If an error message appears on the screen, touch the display and perform the above steps again.

#### **NOTES**

- When an iPhone/smartphone (Android) on which PxLink app is installed is connected to the main unit and information about the latest firmware update is received, a notification is displayed on the screen of the main unit.  
For details on the notification, check [Notifications] under Communication settings (page 96).
- If the update is not complete after a notification regarding the latest firmware has been received, the settings icon and the [Notifications] and [Firmware Update] setting items will be displayed with a red badge.
- For details on how to update the firmware wirelessly and for any other doubts, check PxLink app Help.
- If the firmware update process does not start or does not work well, touch [Connection] to display the device list and touch  to disconnect Android Auto and retry.





# Settings

You can adjust various settings in the main menu.

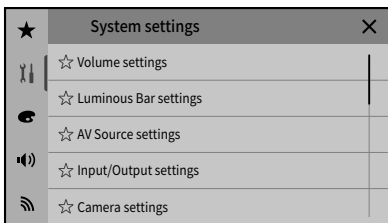
## Displaying the setting screen

- 1 Touch .
- 2 Touch .
- 3 Touch one of the following categories, then select the options.





-  System settings (page 79)
-  Theme settings (page 89)
-  Audio settings (page 91)
-  Communication settings (page 95)

## Favorite menu

Register your favorite menu items in [Favorites] to be able to quickly navigate from the [Favorites] screen to the desired menu screen with a single touch.

- Up to 12 menu items can be registered in the favorite menu.

### Registering the menu items in Favorites

- 1 Touch .
- 2 Touch .

- 3** Touch the star icon of the menu item to register in Favorites.

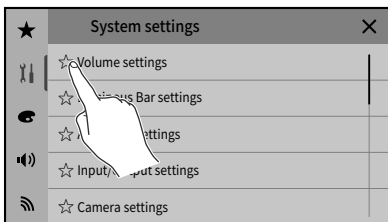



The star icon for the selected menu is filled in.

To cancel the registration, touch the star icon in the menu column again.

### Selecting a menu item registered in Favorites

- 1** Touch .
- 2** Touch .
- 3** Touch .
- 4** Touch the desired menu item.

### Deleting a menu item registered in Favorites

- 1** Touch .
- 2** Touch .
- 3** Touch .
- 4** Touch and hold the menu item that you want to remove.  
The selected menu item is removed from the [Favorites] screen.

## System settings

The menu items vary according to the source.

### [Volume settings]

Menu Item	Description
[Operation Sounds] [On] [Off]	Set the operation sounds for the main unit.
[Receiver Volume] [0] to [40]	Touch [+]/[-] to adjust the volume of the speaker's voice.
[Ring Volume] [0] to [40]	Touch [+]/[-] to adjust the ring volume.

### [Luminous Bar settings]

Menu Item	Description
[Brightness] [1] to [10]	Touch ◀ or ▶ to adjust the brightness of the luminous bar.
[Guidance] [On] [Off]	Set whether to link the directions of the application being used on Apple CarPlay or Android Auto with the luminous bar.
[Music Sync] [Mode1] [Mode2] [Off]	Set the manner of linking the music or audio being played with the luminous bar.
[Ambient Light] [On] [Off]	Touch [On] to keep the luminous bar lit at all times. Even if this is set to [Off], if [Guidance] is [On], the luminous bar lights up when road directions are being given.

### [AV Source settings]

Menu Item	Description
[Radio settings]	(page 51)
[SiriusXM settings]	(page 56)
[USB settings]	(page 71)

### [Input/Output settings]

Menu Item	Description
[AV Input] [2nd Camera] [Maestro] [Off]	Select AV input source.
[2nd Camera view] [Normal] [Reverse]	Select the way the screen image of a camera appears.

Menu Item	Description
[AUX Input] [On] [Off]	Set to [On] for AUX source (page 72).

## [Camera settings]

A separately sold rear view camera (e.g. ND-BC010) is required for utilizing the rear view camera function. (For details, consult your dealer.)

- The range projected by the rear view camera is limited. Also, the vehicle width and distance guidelines displayed on the rear view camera image may differ from the actual vehicle width and distance. (The guidelines are straight lines.)
- The image quality may deteriorate depending on the usage environment, such as at night or in dark surroundings.

### ►Rear view camera

This product features a function that automatically switches to the full-screen image of the rear view camera installed on your vehicle when the shift lever is in the REVERSE (R) position. Camera View mode also allows you to check what is behind you while driving.

- The parking assist guidelines can be displayed temporarily on the rear view camera screen by touching the icon at the top left of the screen. The guidelines can be adjusted. For details on how to adjust the guidelines, see [Parking Assist Guide Adjust] (page 82).

### ►Camera for Camera View mode

Camera View can be displayed at all times. Note that with this setting, the camera image is not resized to fit, and that a portion of what is seen by the camera is not viewable.

To display the camera image, touch [Camera View] on the source/application selection screen (page 28).

- To set the rear view camera as the camera for Camera View mode, set [Back-up Camera Input] to [On] (page 82).
- When using the 2nd camera, set [AV Input] to [2nd Camera] (page 80).
- When the camera view of both the rear view camera and 2nd camera are available, the key to switch the display appears. Touch this key to switch the display between the rear view image and 2nd camera image.

## CAUTION

Pioneer recommends the use of a camera which outputs mirror reversed images, otherwise the screen image may appear reversed.

- Immediately verify whether the display changes to the rear view camera image when the shift lever is moved to REVERSE (R) from another position.
- When the screen changes to full-screen rear view camera image during normal driving, switch to the opposite setting in [Camera Polarity].
- If you touch  while the camera image is displayed, the displayed image turns off temporarily.

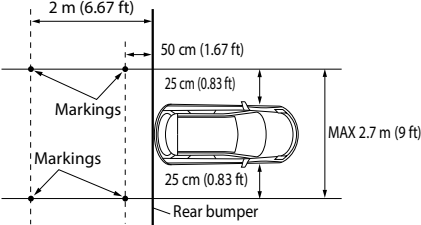
Menu Item	Description
[Back-up Camera Input] [Off] [On]	Setting rear view camera activation.
[Camera Polarity]	Setting the polarity of the rear view camera.
[Battery]	The polarity of the connected lead is positive.
[Ground]	The polarity of the connected lead is negative. • This function is available when [Back-up Camera Input] is set to [On].
[Parking Assist Guide Adjust]*	<p><b>1 Adjusting the guidelines by dragging or touching ▲/▼/◀/▶/↔/↔ on the screen.</b> Touch [Default] to reset the settings.</p> <p><b>2 Turn the vehicle off before getting out to place the markings.</b></p> <p><b>⚠ CAUTION</b> When adjusting the guidelines, park the vehicle in a safe place and apply the parking brake; this setting is available only when the vehicle is parked with the parking brake applied.</p> <p><b>3 Use painter's tape or similar tape to place markings as shown below before setting up the guidelines.</b></p>  <p><b>4 Adjust the guidelines so that they overlay the tape markings as closely as possible.</b> Install the rear view camera as near the center of the vehicle as possible, and do not install it too low. Otherwise, the guideline comes on the edge of the screen, preventing the guideline from being adjusted.</p>

\* This setting may not be available according to the connected camera if the iDataLink adaptor is connected to the unit.

### [Parking Security settings]

Menu Item	Description
<b>[Parking Security Mode]</b> [On] [Off]	When this setting is set to [On], both ends of the luminous bar flash red during parking.

### [Video Signal settings]

Menu Item	Description
<b>[AUX]</b> [Auto] [PAL] [NTSC] [PAL-M] [PAL-N] [SECAM]	Select the suitable video signal setting when you connect this product to an AUX equipment.
<b>[Back-up Camera]</b> [Auto] [PAL] [NTSC]	Select the suitable video signal setting when you connect this product to a rear view camera.
<b>[2nd Camera]</b> [Auto] [PAL] [NTSC]	Select the suitable video signal setting when you connect this product to a 2nd camera.
<b>[RSE]</b> [Auto] [PAL] [NTSC] [PAL-M] [PAL-N] [SECAM]	Select the suitable video signal setting when you connect this product to a rear monitor via iDataLink.

### [Companion App Key settings]

Menu Item	Description
<b>[Companion App Key settings]</b> [PxLink] [Phone]	Set the screen to display when  is touched. For details on the screen that is displayed, see "Main unit" (page 11).

### [Demo Mode]

Menu Item	Description
<b>[Demo Mode]</b> [On] [Off]	Setting the demo mode.

## [Steering Wheel Control]

Menu Item	Description
[Steering Wheel Control] [Off] [With Adapter]	Select [With Adapter] or [Off] according to your wired remote control. <ul style="list-style-type: none"> <li>• This setting is available only when you stop your vehicle in a safe place and apply the handbrake.</li> <li>• Depending on your vehicle, this function may not work properly. In this case, contact your dealer or an authorised PIONEER Service Station.</li> </ul>

## [Restore settings]

- This setting is available only when you stop your vehicle in a safe place and apply the parking brake.
- The source is turned off and the Bluetooth connection is disconnected before the process starts.
- Before starting the restore process, disconnect any device that is connected to the USB port. Otherwise, some settings may not be restored correctly.



### CAUTION

Do not turn off the engine while restoring the settings.

Menu Item	Description
[Restore All settings]	Touch [Restore] to restore the settings to the default settings.
[Restore Audio settings]	To initialize the contents set in [Audio settings], touch [Restore].
[Restore Bluetooth settings]	To initialize the settings related to Bluetooth, touch [Restore].

## [Dimmer settings]

This setting is available only when you stop your vehicle in a safe place and apply the parking brake.

Menu Item	Description
[Dimmer Trigger]	Setting the dimmer brightness. When [Dimmer] is selected in the [Appearance] setting (page 90), the Light mode or the Dark mode is switched automatically according to the following settings.
[Auto]	Switches the dimmer to on or off automatically according to your vehicle's headlight turning on or off.

Menu Item	Description
[Manual]	Switches the dimmer to on or off manually.
[Time]	Switches the dimmer to on or off at the time you adjusted.
<b>[Day/Night]</b>	Setting the dimmer duration by day or night. You can use this function when [Dimmer Trigger] is set to [Manual].
[Day]	Turns the dimmer function to off.
[Night]	Turns the dimmer function to on.
<b>[Dimmer Duration]</b>	<p>Adjust the time that the dimmer is turned on or off by dragging the cursors or touching ◀ or ▶.</p> <p>You can use this function when [Dimmer Trigger] is set to [Time].</p> <ul style="list-style-type: none"> <li>• Each touch of ◀ or ▶ moves the cursor backward or forward in the 15 minute width.</li> <li>• When the cursors are placed on the same point, the dimmer available time is 0 hours.</li> <li>• When the cursor for off time setting is placed on the left end and the cursor for on time setting is placed on the right end, the dimmer available time is 0 hours.</li> <li>• When the cursor for on time setting is placed on the left end and the cursor for off time setting is placed on the right end, the dimmer available time is 24 hours.</li> <li>• The time display of the dimmer duration adjusting bar depends on the clock display setting (page 98).</li> </ul>

### [Clock settings]





Menu Item	Description
<b>[Clock settings]</b>	<p>Setting or adjusting the following time and clock display.</p> <ul style="list-style-type: none"> <li>• Date display format: day-month-year, month-day-year, or year-month-day</li> <li>• Time display format: [12hour] or [24hour]</li> <li>• UTC (Universal Time Coordinated) time zone difference: [UTC-12h] to [UTC+14h]</li> <li>• Day-light saving time: [ON] or [OFF]</li> </ul>

### [Picture Adjustment]

You can adjust the picture settings for each source, including the rear view camera.

## CAUTION

For safety reasons, you cannot use some of these functions while your vehicle is in motion. To enable these functions, you must stop in a safe place and apply the parking brake.

To adjust following menu, touch , , ,  to adjust.

Menu Item	Description
<b>[Brightness]</b> [-24] to [+24]	Adjust the black intensity.
<b>[Contrast]</b> [-24] to [+24]	Adjust the contrast.
<b>[Color]*</b> [-24] to [+24]	Adjust the color saturation.
<b>[Hue]*</b> [-24] to [+24]	Adjust the tone of color (which color is emphasized, red, or green).
<b>[Dimmer]</b> [+1] to [+48]	Adjust the brightness of the display.
<b>[Temperature]</b> [-3] to [+3]	Adjust the color temperature, resulting in a better white balance.

\* With some pictures, you cannot adjust [Hue] and [Color].

### NOTES

- The adjustments of [Brightness], [Contrast], and [Dimmer] are stored separately when your vehicle's headlights are off (daytime) and on (nighttime).
- [Brightness] and [Contrast] are switched automatically depending on the setting of [Dimmer settings].
- [Dimmer] can be changed the setting or the time to switch it to on or off (page 84).
- The picture adjustment may not be available with some rear view cameras.
- The setting contents can be memorized separately.

### [System Information]

Menu Item	Description
<b>[Firmware Information]</b>	Displaying the firmware version.

Menu Item	Description
[Firmware Update]	<p>Update to the latest version of the firmware by using a USB storage device or wireless connection. To update the firmware via wireless connection, PxLink app is required. For details on performing the wireless update, refer to Updating the firmware wirelessly (page 76). When information about the latest firmware update is received, a notification badge is displayed in the [Firmware Update] item.</p> <p> <b>CAUTION</b></p> <ul style="list-style-type: none"><li>• The USB storage device for updating must contain only the correct update file.</li><li>• Never turn this product off, disconnect the USB storage device while the firmware is being updated.</li><li>• You can only update the firmware when the vehicle is stopped and the parking brake is engaged.</li></ul> <ol style="list-style-type: none"><li><b>1 Download the firmware update files into your computer.</b></li><li><b>2 Connect a blank (formatted) USB storage device to your computer then locate the correct update file and copy it onto the USB storage device.</b></li><li><b>3 Connect the USB storage device to this product (page 66).</b></li><li><b>4 Turn the source off (page 28).</b></li><li><b>5 Display the [System settings] screen (page 78).</b></li><li><b>6 Touch [System Information].</b></li><li><b>7 Touch [Firmware Update].</b></li><li><b>8 Touch [Yes].</b></li></ol> <p>Follow the on-screen instructions to finish updating the firmware.</p> <p><b>NOTES</b></p> <ul style="list-style-type: none"><li>• This product will reset automatically after the firmware update is completed if the update is successful.</li><li>• If an error message appears on the screen, touch the display and perform the above steps again.</li><li>• If the update is not complete after a notification regarding the latest firmware has been received, the settings icon and the [Notifications] and [Firmware Update] setting items will be displayed with a red badge.</li></ul>

Menu Item	Description
[3D Calibration Status]	<p>Check the sensor learning status, such as the degree of learning. You can also check the current sensor values and the total number of speed pulses.</p> <p>To delete the learned results stored in the sensor, follow the below instructions.</p> <ul style="list-style-type: none"> <li>• Touch [Reset All] to reset the sensor after changing the installation position or angle.</li> <li>• If you touch [Reset Distance], all learned results stored in [Distance] are cleared.</li> </ul> <p><b>1 Touch [Distance] or [Speed Pulse], and then touch [Yes].</b></p> <p><b>2 Touch [Learning status] and then touch [Reset All].</b></p>
[Connection Status]	<p>Check that the leads are properly connected between this product and vehicle.</p>
[GPS Antenna]	<p>Displays the connection status of the GPS antenna ([OK] or [NOK]) and the reception sensitivity.</p> <ul style="list-style-type: none"> <li>• If reception is poor, change the installation position of the GPS antenna.</li> </ul>
[Positioning Status]	<p>Displays the positioning status (3D positioning, 2D positioning, or no positioning), the number of satellites used for positioning (orange), and the number of satellites that have received signals (yellow). If signals from more than three satellites are received, the current location can be measured.</p>
[Installation]	<p>Indicates whether the installation position of this product is correct or not. If installed correctly, [OK] appears. When this product is installed at an extreme angle exceeding the limitation of the installing angle, [NOK(Inst. Angle)] is displayed. If the installation of this product is continually changed and it is not firmly fixed into place, [NOK(Vibration)] is displayed.</p>
[Speed Pulse]	<p>The speed pulse value detected by this product is shown.</p>
[Back Signal]	<p>When the shift lever is shifted to "R" (reverse position), the signal switches to [High] or [Low]. The signal displayed varies depending on the vehicle.</p>
[Parking brake]	<p>When the parking brake is applied, [ON] is displayed, and when the parking brake is released, [OFF] is displayed.</p>
[Illumination]	<p>When the vehicle lights are illuminated, [ON] is displayed, and when the vehicle lights are turned off, [OFF] is displayed.</p>
[License]	<p>Displays the open source license for this unit.</p>

## [System Language]

Menu Item	Description
[System Language]	<p>Select the system language.</p> <ul style="list-style-type: none"> <li>If the programmed language and the selected language setting are not the same, the text information may not display properly.</li> <li>Some characters may not be displayed properly.</li> </ul>

## [OEM settings]

Menu Item	Description
[OEM settings]	(page 62).

## [OEM Volume settings]









Menu Item	Description
[OEM Volume settings]	(page 62).



## Theme settings

The menu items vary according to the source.







Menu Item	Description
[Background]	<p>Select the wallpaper from the preset items of the main unit or an original image via PxLink app.</p> <p>The wall paper can be set from selections for the home menu screen and AV operation screen.</p> <ul style="list-style-type: none"> <li>You can preview how each wallpaper will appear in [Light mode] or [Dark mode].</li> <li>The [Background] settings are saved for each cellular phone connected via Bluetooth. The settings change depending on the cellular phone that is connected to this unit. If two cellular phones are connected to this unit at the same time, the settings of the first phone are applied.</li> </ul>
Preset Display	<p>Select the desired preset background display.</p> <ul style="list-style-type: none"> <li>When the preset background display image with the  icon (for the AV operation screen only) is selected, the color changes to match the color of the artwork image.</li> </ul>









Menu Item	Description
 (custom)	Displays the wallpaper image transferred from PxLink app. <ul style="list-style-type: none"> <li>Depending on the selected background image, the characters on the display may be difficult to see. In that case, try to set [Background Filter ON].</li> </ul>
 (off)	Hides the background display.
<b>[Illumination]*1</b>	Select an illumination color from the color list or create a defined color.
Colored Keys	Select the desired preset color.
 (custom)	Displays the screen to customize the illumination color. To customize the defined color, touch  then touch  or  to adjust the brightness and the level of red, green and blue to create favorite color. To store the customized color in the memory, touch and hold [Memo], and the customized color will be available at the next illumination setting by touching  . <ul style="list-style-type: none"> <li>You can also adjust the color tone by dragging the color bar.</li> </ul>
 (rainbow)	Shifts gradually between the preset colors in sequence.
<b>[Appearance]</b>	Switches the screen appearance to Light mode or Dark mode. (This setting is also applied to the screen of Apple CarPlay or Android Auto.)
[Dimmer]	Switches to the Light mode or the Dark mode automatically according to the [Dimmer settings] (page 84).
[Light]	Sets the Light mode to see the screen clearly under strong sunlight.
[Dark]	Sets the Dark mode when the inside of your vehicle is dark.
<b>[Splash screen]</b> [Import] [Restore]	Select [Import] to change the image on the opening screen to the one imported from the connected USB device. Select [Restore] to restore the default image. <ul style="list-style-type: none"> <li>The image files that can be imported are as follows:               <ul style="list-style-type: none"> <li>Format: JPEG</li> <li>Data size: 3.5 MB or less</li> <li>Image size (W × H): The product of the vertical and horizontal dimensions of the image must be within 2 880 000 pixels (e.g., 1 920 × 1 080, 2 436 × 1 125, etc.)</li> </ul> </li> <li>If multiple image files are stored on the USB device, the desired image file may not be imported from the USB device. Store only one desired image file on the USB device.</li> </ul>

\*1 You can preview the home menu screen or the AV operation screen by touching [Home] or [AV] respectively.

## Audio settings

The menu items vary according to the source. Some of the menu items become unavailable when the volume is set to mute.

Menu Item	Description
<b>[Fader/Balance]</b>	Touch  or  to adjust the front/rear speaker balance. Set [Front] and [Rear] to [0] when using a dual speaker system. Touch  or  to adjust the left/right speaker balance. <ul style="list-style-type: none"><li>You can also set the value by dragging the point on the displayed table.</li><li>This function is available when [Standard Mode] is selected as the speaker mode and [Rear] is selected in [Rear Speaker Output].</li></ul>
<b>[Loudness]</b> [Off] [Low] [Mid] [High]	Compensates for deficiencies in the low-frequency and high-frequency ranges at low volume.
<b>[Auto Sound Levelizer]</b> [OFF] [LOW] [MID-LOW] [MID] [MID-HIGH] [HIGH]	Corrects the volume according to the travel speed.
<b>[Source Level Adjuster]</b> [-4] to [+4]	Adjust the volume level of each source to prevent radical changes in volume when switching between sources other than FM. Touch  or  to adjust the source volume after comparing the FM tuner volume level with the level of the source. <ul style="list-style-type: none"><li>If you directly touch the area where the cursor can be moved, the SLA (source level adjustment) setting will be changed to the value of the touched point.</li><li>Settings are based on the FM tuner volume level, which remains unchanged.</li><li>This function is not available when the FM tuner is selected as the AV source.</li></ul>
<b>[Sound Retriever]</b> [Off] [Mode1] [Mode2]	Enhances compressed audio and restores rich sound automatically. <ul style="list-style-type: none"><li>[Mode2] has a stronger effect than [Mode1].</li></ul>

Menu Item	Description
<p><b>[Speaker Level]</b>  <b>Listening Position*1*2</b>            [Off] [Front Left]            [Front Right] [Front] [All]</p> <p><b>Standard Mode*3</b>            [Front Left] [Front Right]            [Rear Left] [Rear Right]            [Subwoofer]</p> <p><b>Network Mode*3</b>            [High Left] [High Right]            [Mid Left] [Mid Right]            [Subwoofer]</p> <p><b>Speaker output level</b>            [-24] to [10]</p>	<p>Adjust the speaker output level of the listening position.</p> <ul style="list-style-type: none"> <li>You can adjust the subwoofer output level if the [Subwoofer] setting is set to [On].</li> </ul> <ol style="list-style-type: none"> <li>1 Touch  or  to select the listening position then select the output speaker.</li> <li>2 Touch  or  to adjust the selected speaker output level.</li> </ol>
<p><b>[Listening Position]*1</b>            [Off] [Front Left]            [Front Right] [Front] [All]</p>	<p>Select a listening position that you want to make as the center of sound effects.</p>
<p><b>[Time Alignment]</b>            [On] [Off]</p> <p><b>Listening Position*1*2</b>            [Off] [Front Left]            [Front Right] [Front] [All]</p> <p><b>Standard Mode*3*4</b>            [Front Left] [Front Right]            [Rear Left] [Rear Right]            [Subwoofer]</p> <p><b>Network Mode*3*4</b>            [High Left] [High Right]            [Mid Left] [Mid Right]            [Subwoofer]</p> <p><b>Distance</b>            [0] to [150]</p>	<p>Select or customize the time alignment settings to reflect the distance between the listener's position and each speaker. You need to measure the distance between the head of the listener and each speaker unit.</p> <ul style="list-style-type: none"> <li>If you touch [TA On], the time alignment is turned off mandatorily.</li> <li>This function is available only when the listening position setting is set to [Front Left] or [Front Right].</li> </ul> <ol style="list-style-type: none"> <li>1 Touch  or  to select the listening position then select the alignment speaker.</li> <li>2 Touch  or  to input the distance between the selected speaker and listening position.</li> </ol>

Menu Item	Description
<b>[EQ]</b> [Super Bass (S.Bass)] [Powerful] [Natural] [Vocal] [Flat] [Custom1] [Custom2]	Select or customize the equalizer curve. Select a curve that you want to use as the basis of customizing then touch the frequency that you want to adjust. <ul style="list-style-type: none"> <li>• If you make adjustments when a curve [Super Bass (S.Bass)], [Powerful], [Natural], [Vocal] or [Flat] is selected, the equalizer curve settings will be changed to [Custom1] mandatorily.</li> <li>• If you make adjustments when the [Custom2] curve is selected for example, the [Custom2] curve will be updated.</li> <li>• [Custom1] and [Custom2] curves can be created common to all sources.</li> <li>• If you trail a finger across the bars of multiple equalizer bands, the equalizer curve settings will be set to the value of the touched point on each bar.</li> </ul>
<b>[Subwoofer]</b> [On] [Off]	Select enable or disable rear subwoofer output from this product.
<b>[Crossover]</b>	Select a speaker unit (filter) to adjust the HPF or LPF cutoff frequency and the slope for each speaker unit (page 94).
<b>[Bass Boost]</b> [0] to [+6]	Adjust the bass boost level.
<b>[Rear Speaker Output]</b> [Rear] [Subwoofer]	Select the rear speaker output. <ul style="list-style-type: none"> <li>• This function is available when [Standard Mode] is selected as the speaker mode and the source is off.</li> </ul>
<b>[Mute Level]</b>	If an interruption caused by an audio signal occurs while Apple CarPlay or Android Auto is being used, select mute or attenuate the volume of the AV source and iPhone/ smartphone application.
[ATT]	The volume becomes 10 dB lower than the current volume.
[Mute]	The volume becomes 0.
[Off]	The volume does not change.
<b>[Subwoofer settings]</b>	Select the subwoofer phase (page 94).
<b>[Save settings]</b>	Save to recall the following current sound settings by touching [OK]: slope, subwoofer phase, speaker level, EQ, HPF/LPF, listening position, crossover, time alignment. <ul style="list-style-type: none"> <li>• When you touch [Cancel], return to the [Audio settings] screen.</li> </ul>

Menu Item	Description
<b>[Load settings]</b> [Initial settings] [Sound setting]	Load the sound settings. • [Sound setting] is available only when you have already saved the sound settings (page 93).

- \*1 [All] is not available when [Network Mode] is selected as the speaker mode.
- \*2 If you change the listening position setting, the set values for all speakers will change in conjunction with this setting.
- \*3 To use this function, the vehicle's acoustics must be measured in advance.
- \*4 This function is available only when the listening position setting is set to [Front Left] or [Front Right].

## Adjusting the cutoff frequency value





You can adjust the cutoff frequency value of each speaker.

The following speakers can be adjusted:

**[Standard Mode]:** Front, Rear, Subwoofer.

**[Network Mode]:** High, Mid, Subwoofer.

• [Subwoofer settings] is available only when [Subwoofer] is [On].

- 1 Touch .
- 2 Touch  then .
- 3 Touch [Crossover] or [Subwoofer settings].
- 4 Touch  or  to switch the speaker.
- 5 Drag the graph line to set the cutoff position.
- 6 Drag the lowest point of the graph to set the cutoff slope.

The following items can also be set.

	Switches the subwoofer phase between normal and reverse position. • You can also adjust the [High] and [Mid] phase in [Network Mode].
<b>[LPF]/[HPF]</b>	Switches the [LPF]/[HPF] setting to [On] or [Off]. When it is turned off, the high-pass filter or low-pass filter of each speaker can also be turned on by touching the graph lines.



## Communication settings

### [Connection]

Menu Item	Description
[Connection]	<p>Displaying a list of mobile devices that have been connected via Bluetooth or USB. Connect, disconnect, or delete registered mobile device manually. Touch  to delete registered device. To connect a registered device manually, perform the following:</p> <ul style="list-style-type: none"><li>• For an Apple CarPlay or Android Auto connection, touch the icon of the device.</li><li>• For a Bluetooth connection, touch .</li></ul> <p>To disconnect the device, touch  in the list.</p> <p><b>TIP</b> If there are no devices in the list, the device search list screen will appear so you can connect a selected device.</p> <p><b>NOTES</b></p> <ul style="list-style-type: none"><li>• Connect the Bluetooth device manually in the following cases:<ul style="list-style-type: none"><li>– Two or more Bluetooth devices are registered, and you want to manually select the device to be used.</li><li>– You want to reconnect a disconnected Bluetooth device.</li><li>– Connection cannot be established automatically for some reason.</li></ul></li><li>• If you have deleted the registered Bluetooth device from the unit, also delete the registered unit's information from your iPhone or smartphone.</li></ul>

### [Bluetooth settings]

Setting the Bluetooth (page 21) and Hands-free phone (page 41).

### [Wi-Fi settings]

Menu Item	Description
[Wi-Fi settings]	(page 23).

## [Driving Position]

Menu Item	Description
[Driving Position] [Right] [Left]	<p>Setting the driving position.</p> <ul style="list-style-type: none"> <li>• Apple CarPlay (page 29)</li> </ul> <p><b>NOTE</b> The position of the shortcuts on the home menu screen depends on the driving position setting (page 16).</p>

## [Notifications]

Menu Item	Description
[Notifications]	<p>A notification is displayed if it is possible to update to the latest version of the firmware.</p> <p>If there is a notification of a firmware update that has not been checked, a badge is displayed in the [Notifications] item.</p> <p><b>NOTE</b> If the update is not complete after a notification regarding the latest firmware has been received, the settings icon and the [Notifications] and [Firmware Update] setting items will be displayed with a red badge.</p>

## [Companion App Info]

Menu Item	Description
[Companion App Info]	<p>A screen with information on downloading PxLink app is displayed.</p> <p>Touch [Connect] to display a screen with information on linking the main unit and PxLink app.</p> <p>Touch [Skip] to display the home menu screen.</p> <p>If the main unit and PxLink app are not linked, a badge is displayed in the [Companion App Info] item.</p> <p><b>NOTE</b> If linking to PxLink app is not complete, the settings icon and [Companion App Info] setting item will be displayed with a red badge.</p>

## [Android Auto Auto-launch]

Menu Item	Description
[Android Auto Auto-launch] [On] [Off]	Select [On] to display the Android Auto screen automatically when an Android device is connected to the unit.

# Other functions

## Setting the clock display

You can set the time format, time zone, daylight saving, and the date format. However, the time and date are automatically adjusted by the GPS antenna and cannot be adjusted by the user.

**1 Touch the current time on the screen.**

**2 Set the following items in the settings.**

- The date display format:  
day-month-year, month-day-year, or year-month-day
- The time display format:  
[12hour] or [24hour]
- The UTC (Universal Time Coordinated) time zone difference:  
[UTC-12h] to [UTC+14h]
- Day-light saving time:  
[ON] or [OFF]

You can also configure these items in [Clock settings] (page 85).

## Changing the widescreen mode

You can set the screen mode for the AV screen and image files.

- Different settings can be stored for each video source.
- Depending on the software version of this unit, this function may vary.

## 1 Touch the screen display mode key.

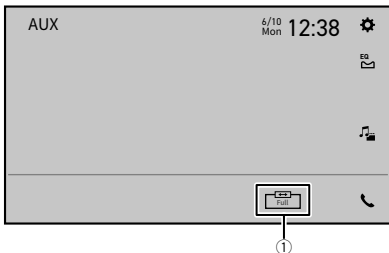

①

**Screen display mode key**

## 2 Touch the desired mode.

When a video is viewed in the widescreen mode with a setting that does not match its original aspect ratio, it may appear different.

Image files can be set to either [Normal] or [Trimming] in the widescreen mode.

[Full]	Displays images across the entire screen. • Some images may not be displayed across the entire screen.
[Zoom]	Displays images by enlarging them vertically. • The video image will appear coarser when viewed in [Zoom] mode.
[Normal]	Displays images without changing the ratio.
[Trimming]	An image is displayed across the entire screen with the horizontal-to-vertical ratio left as-is. If the screen ratio differs from the image, the image may be displayed partly cut off either at the top/bottom or sides. • [Trimming] is for image files only.

## About the reconnection function

You can reconnect the iPhone or smartphone by touching [Reconnect] on the home menu screen.

### TIPS

- [Reconnect] is displayed on the home menu screen only when the Wi-Fi connection (Wireless Apple CarPlay or Android Auto) has failed or been disconnected automatically.
- If you touch [Reconnect], the message confirming whether to restart this product appears on the display. Touch [Yes] to restart this product.

## Restoring this product to the default settings

You can restore settings or recorded content to the default settings from [Restore all settings] in  (page 84).

# Compatible iPhone models

- iPhone 14 Pro Max
- iPhone 14 Pro
- iPhone 14 Plus
- iPhone 14
- iPhone SE (3rd generation)
- iPhone 13 Pro Max
- iPhone 13 Pro
- iPhone 13
- iPhone 13 mini
- iPhone 12 Pro Max
- iPhone 12 Pro
- iPhone 12
- iPhone 12 mini
- iPhone SE (2nd generation)
- iPhone 11 Pro Max
- iPhone 11 Pro
- iPhone 11
- iPhone XR
- iPhone XS Max
- iPhone XS
- iPhone X
- iPhone 8
- iPhone 8 Plus

Depending on the iPhone models, it may not be compatible with some AV sources. For details about iPhone compatibility with this product, refer to the information on our website.

# Handling the USB connector

## CAUTION

- To prevent data loss and damage to the storage device, never remove it from this product while data is being transferred.
- Pioneer cannot guarantee compatibility with all USB mass storage devices and assumes no responsibility for any loss of data on media players, iPhone, smartphone, or other devices while using this product.
- It may not be recognized properly by this product if a USB device that had been incorrectly disconnected from the computer is connected.

# Detailed information for playable media

## Compatibility

### Common notes about the USB storage device

- Do not leave the USB storage device in any location with high temperatures.
- Depending on the kind of the USB storage device you use, this product may not recognize the storage device or files may not be played back properly.
- The text information of some audio and video files may not be correctly displayed.
- File extensions must be used properly.
- There may be a slight delay when starting playback of files on an USB storage device with complex folder hierarchies.
- Operations may vary depending on the kind of an USB storage device.
- It may not be possible to play some music files from USB because of file characteristics, file format, recorded application, playback environment, storage conditions, and so on.

### USB storage device compatibility

- For details about USB storage device compatibility with this product, refer to Specifications (page 107).
- Protocol: bulk
- You cannot connect a USB storage device to this product via a USB hub.
- Partitioned USB storage device is not compatible with this product.
- Firmly secure the USB storage device when driving. Do not let the USB storage device fall onto the floor, where it may become jammed under the brake or gas pedal.
- There may be a slight delay when starting playback of audio files encoded with image data.
- Some USB storage devices connected to this product may generate noise on the radio.
- Do not connect anything other than the USB storage device.

### Handling guidelines and supplemental information

- Copyright protected files cannot be played back.

# Media compatibility chart

## General

- Maximum playback time of audio file stored on a USB storage device: 8 h (480 minutes)

## USB storage device

CODEC FORMAT	MP3, WMA, WAV, AAC, FLAC, AVI, MPEG-PS, MPEG-TS, MP4, 3GP, MKV, MOV, ASF, FLV, M4V
--------------	--

## MP3 compatibility

- Ver. 2.x of ID3 tag is prioritized when both Ver. 1.x and Ver. 2.x exist.
- This product is not compatible with the following: MP3i (MP3 interactive), mp3 PRO, m3u playlist

SAMPLING FREQUENCY	8 kHz to 48 kHz
TRANSMISSION RATE	8 kbps to 320 kbps (CBR)/VBR
ID3 TAG	Folder Browse mode ver.1.0/1.1/2.2/2.3/2.4 Music Browse mode ver.2.2/2.3/2.4

## WMA compatibility

- This product is not compatible with the following: Windows Media™ Audio 9.2 Professional, Lossless, Voice

SAMPLING FREQUENCY	32 kHz to 48 kHz
TRANSMISSION RATE	8 kbps to 320 kbps (CBR)/VBR

## WAV compatibility

- If the sampling frequency of the file exceeds 48 kHz, the sampling frequency is reduced automatically to 48 kHz when the file is played.

SAMPLING FREQUENCY	16 kHz to 192 kHz
QUANTIZATION BIT RATE	8 bit/16 bit/24 bit/32 bit (int only)

## AAC compatibility

- This product plays back AAC files encoded by iTunes.

SAMPLING FREQUENCY	8 kHz to 48 kHz
TRANSMISSION RATE	16 kbps to 320 kbps (CBR)

## FLAC compatibility

- If the sampling frequency of the file exceeds 48 kHz, the sampling frequency is reduced automatically to 48 kHz when the file is played.

SAMPLING FREQUENCY	8 kHz to 192 kHz
QUANTIZATION BIT RATE	8 bit/16 bit/24 bit

## Video files compatibility

- Files may not be played back properly depending on the environment in which the file was created or on the contents of the file.
- This product is not compatible with packet write data transfer.
- This product can recognize up to 32 characters, beginning with the first character, including extension for the file and folder name. Depending on the display area, this product may try to display them with a reduced font size. However, the maximum number of the characters that you can display varies according to the width of each character, and of the display area.
- Folder selection sequence or other operations may be altered, depending on the order in which files are saved to the USB storage device.
- Regardless of the length of blank section between the songs of original recording, compressed audio files play with a short pause between songs.
- Files may not be able to be played back depending on the bit rate.
- The maximum resolution depends on the compatible video codec.
- This product's display does not have Full HD rendering capability.

### .avi

Maximum resolution	1 920 × 1 080
Maximum frame rate	30 fps

### .mpg/.mpeg

Maximum resolution	720 × 576
Maximum frame rate	30 fps

### .mp4

Maximum resolution	1 920 × 1 080
Maximum frame rate	30 fps

**.3gp**

Maximum resolution	1 920 × 1 080
Maximum frame rate	30 fps

**.mkv**

Maximum resolution	1 920 × 1 080
Maximum frame rate	30 fps

**.mov**

Maximum resolution	1 920 × 1 080
Maximum frame rate	30 fps

**.flv**

Maximum resolution	1 920 × 1 080
Maximum frame rate	30 fps

**.wmv/.asf**

Maximum resolution	1 920 × 1 080
Maximum frame rate	30 fps

**.m4v**

Maximum resolution	1 920 × 1 080
Maximum frame rate	30 fps

**.ts/.m2ts/.mts**

Maximum resolution	1 920 × 1 080 (MPEG4, H.264), 720 × 576 (MPEG2)
Maximum frame rate	30 fps

**NOTE**

This product assigns folder numbers. The user cannot assign folder numbers.

# Specifications

## General

Rated power source:

14.4 V DC (10.8 V to 15.1 V allowable)

Grounding system:

Negative type

Maximum current consumption:

10.0 A

Dimensions (W × H × D):

Body (excluding the monitor mounting part):

178 mm × 50 mm × 156 mm (7 in. × 2 in. × 6-1/8 in.)

Nose:

170 mm × 46 mm × 10.5 mm (6-3/4 in. × 1-3/4 in. × 3/8 in.)

Monitor:

259.5 mm × 164 mm × 36 mm (10-1/4 in. × 6-1/2 in. × 1-3/8 in.)

Weight:

Body:

0.98 kg (2.2 lbs)

Monitor:

1 kg (2.2 lbs)

## Display

Screen size/aspect ratio:

10.1 inch wide/16:9 (effective display area: 223.680 mm × 125.820 mm)

Pixels:

1 280 (Width) × 720 (Height) × 3 (RGB)

Display method:

TFT Active matrix driving

Color system:

PAL/NTSC/PAL-M/PAL-N/SECAM compatible

Temperature range:

-10 °C to +60 °C (+14 °F to +140 °F)

## Audio

Maximum power output:

- 50 W × 4
- 50 W × 2 ch/4 Ω + 70 W × 1 ch/2 Ω (for subwoofer)

Continuous power output:

22 W × 4 (50 Hz to 15 kHz, 5 %THD, 4 Ω LOAD, Both Channels Driven)

Load impedance:

4 Ω (4 Ω to 8 Ω [2 Ω for 1 ch] allowable)

Preout output level (max): 4.0 V

Equalizer (13-Band Graphic Equalizer):

Frequency:

50 Hz/80 Hz/125 Hz/200 Hz/315 Hz/500 Hz/800 Hz/1.25 kHz/2 kHz/3.15 kHz/5 kHz/8 kHz/12.5 kHz

Gain: ±12 dB (2 dB/step)

<Standard Mode>

HPF: ON/OFF

Frequency:

25 Hz/31.5 Hz/40 Hz/50 Hz/63 Hz/80 Hz/100 Hz/125 Hz/160 Hz/200 Hz/250 Hz

Slope:

-6 dB/oct, -12 dB/oct, -18 dB/oct, -24 dB/oct

LPF (Subwoofer): ON/OFF

Frequency:

25 Hz/31.5 Hz/40 Hz/50 Hz/63 Hz/80 Hz/100 Hz/125 Hz/160 Hz/200 Hz/250 Hz

Slope:

-6 dB/oct, -12 dB/oct, -18 dB/oct, -24 dB/oct, -30 dB/oct, -36 dB/oct

Phase: Normal/Reverse

Time alignment:

0 to 150 inch (0.6 inch/step)

Speaker level:

-24 dB to +10 dB (1 dB/step)

<Network Mode>

HPF (High):

Frequency:

1.25 kHz/1.6 kHz/2 kHz/2.5 kHz/3.15 kHz/4 kHz/5 kHz/6.3 kHz/8 kHz/10 kHz/12.5 kHz

Slope:

-6 dB/oct, -12 dB/oct, -18 dB/oct, -24 dB/oct

Phase (High): Normal/Reverse

HPF (Mid): ON/OFF

Frequency:

25 Hz/31.5 Hz/40 Hz/50 Hz/63 Hz/80 Hz/100 Hz/125 Hz/160 Hz/200 Hz/250 Hz

Slope:

-6 dB/oct, -12 dB/oct, -18 dB/oct, -24 dB/oct

LPF (Mid): ON/OFF

Frequency:

1.25 kHz/1.6 kHz/2 kHz/2.5 kHz/3.15 kHz/4 kHz/5 kHz/6.3 kHz/8 kHz/10 kHz/12.5 kHz

Slope:

-6 dB/oct, -12 dB/oct, -18 dB/oct, -24 dB/oct

Phase (Mid): Normal/Reverse

LPF (Subwoofer): ON/OFF

Frequency:

25 Hz/31.5 Hz/40 Hz/50 Hz/63 Hz/80 Hz/100 Hz/125 Hz/160 Hz/200 Hz/250 Hz

Slope:

-6 dB/oct, -12 dB/oct, -18 dB/oct, -24 dB/oct, -30 dB/oct, -36 dB/oct

Phase (Subwoofer): Normal/Reverse

Time alignment:

0 to 150 inch (0.6 inch/step)

Speaker level:

-24 dB to +10 dB (1 dB/step)

## USB

USB standard spec:

USB 1.1, USB 2.0 full speed, USB 2.0 high speed

Max current supply: 1.5 A

USB Class:

MSC (Mass Storage Class)

File system: FAT16, FAT32, NTFS, exFAT

<USB audio>

MP3 decoding format:

MPEG-1 & 2 & 2.5 Audio Layer 3

WMA decoding format:

Ver 9.2 Profile L1

AAC decoding format:

AAC-LC (Low Complexity)

FLAC decoding format:

Ver. 1.3.0

Sampling frequency:

8 kHz to 192 kHz

WAV signal format:

Linear PCM

Sampling frequency:

16 kHz/22.05 kHz/24 kHz/32 kHz/44.1 kHz/48 kHz/96 kHz/192 kHz

<USB image>

JPEG decoding format:

.jpeg, .jpg, .jpe

Pixel Sampling: 4:2:2, 4:2:0

Decode Size:

MAX: 7 680 (H) × 8 192 (W)

MIN: 32 (H) × 32 (W)

PNG decoding format:

.png

Decode Size:

MAX: 576 (H) × 720 (W)

MIN: 32 (H) × 32 (W)

BMP decoding format:

.bmp

Decode Size:

MAX: 936 (H) × 1 920 (W)

MIN: 32 (H) × 32 (W)

<USB video>

○ : Supported    — : Not supported

Playable video format (container)		AVI	MP4/M4V	QuickTime (MOV)	WMV	MKV	FLV	MPEG2-PS	TS Stream	3GP
EXTENSION		.avi	mp4/m4v	.mov	.wmv	.mkv	.flv	.mpg/.mpeg	.ts/.m2ts/.mts	.3gp
Video codec	H.264	○	○	○	—	○	○	—	○	—
	H.263	○	○	○	—	—	—	—	—	○
	WMV9 (VC-1)	—	—	—	○	○	—	—	—	—
	MPEG-4	○	○	○	—	○	—	—	○	—
	MPEG-2	—	—	—	—	—	—	○	○	—
Audio codec	WMA	—	—	—	○	—	—	—	—	—
	MP3	○	○	○	○	○	○	○	○	—
	AAC	—	○	○	—	○	○	—	○	○
	LPCM	○	○	○	○	○	—	○	—	—
	Vorbis	—	—	—	—	○	—	—	—	—

## Bluetooth

Version:

Bluetooth 5.2 certified

Output power:

+4 dBm Max. (Power class 2)

Bluetooth Low Energy output power:

+5 dBm Max.

Frequency band(s):

2 402 MHz to 2 480 MHz

Bluetooth profiles:

HFP (Hands Free Profile) 1.7.2

PBAP (Phone Book Access Profile) 1.2.3

A2DP (Advanced Audio Distribution Profile) 1.3.2

AVRCP (Audio/Video Remote Control Profile) 1.6.2

SPP (Serial Port Profile) 1.2

AVCTP (Audio/Video Control Transport Protocol) 1.4

AVDTP (Audio/Video Distribution Transport Protocol) 1.3

DIP (Device ID Profile) 1.3

GAUDP (Generic Audio/Video Distribution Profile) 1.3  
IOP (Interoperability Test Specification)  
OPP (Object Push Profile) 1.2.1  
RFCOMM (RFCOMM with TS 07.10) 1.2

## FM tuner

Frequency range:  
87.9 MHz to 107.9 MHz

## AM tuner

Frequency range:  
530 kHz to 1 710 kHz

## Wi-Fi

Version:  
IEEE 802.11 a/n/ac (5 GHz)  
Frequency channel:  
149 ch (5 GHz)  
Security:  
WPA2 (Personal)/WPA3 (Personal)  
Output power:  
+14.5 dBm Max (5 GHz)

## GPS

GNSS receiver  
System:  
GPS L1C/A, SBAS L1C/A, GLONASS L1OF, Galileo E1B/C  
SPS (Standard Positioning Service)  
Reception system:  
92 channel Multi-channel reception system  
Reception frequency:  
1 575.42 MHz/1 602 MHz  
Sensitivity:  
-140 dBm (typ)  
Sensitivity on product when combined with GPS antenna.  
Frequency:  
Approx. once per second  
GPS antenna

**Antenna:**

Micro strip flat antenna/right-handed helical polarization

**Antenna cable:**

3.55 m (11ft. 7in.)

**Dimensions (W × H × D):**

33 mm × 14.7 mm × 36 mm (1-1/4 in. × 1/2 in. × 1-3/8 in.)

**Weight:**

73.7 g (0.2 lbs)

**NOTE**

Specifications and design are subject to possible modifications without notice due to improvements.

# Trademark · Copyright, etc.

- The Bluetooth® word mark and logos are registered trademarks owned by Bluetooth SIG, Inc. and any use of such marks by Pioneer Corporation is under license. Other trademarks and trade names are those of their respective owners.
- SiriusXM and all related marks and logos are trademarks of Sirius XM Radio, Inc. All rights reserved.



- HD Radio™ Technology manufactured under license from iBiquity Digital Corporation, a subsidiary of Xperi Inc., U.S. and Foreign Patents. For patents see <https://xperi.com/hd-radio-patents/>. Xperi, HD Radio, HD, and 'ARC' logos and their respective logos are trademarks or registered trademarks of Xperi Inc. and its subsidiaries in the United States and other countries.



- Wi-Fi® is a registered trademark of Wi-Fi Alliance®.
- Windows Media is either a registered trademark or trademark of Microsoft

Corporation in the United States and/or other countries.

- This product includes technology owned by Microsoft Corporation and cannot be used or distributed without a license from Microsoft Licensing, Inc.

- AAC is short for Advanced Audio Coding and refers to an audio compression technology standard used with MPEG-2 and MPEG-4. Several applications can be used to encode AAC files, but file formats and extensions differ depending on the application which is used to encode. This unit plays back AAC files encoded by iTunes.

- WebLink® is a registered trademark of Abalta Technologies, Inc.

- Google, Android, Google Play, Android Auto and other marks are trademarks of Google LLC.

- This Product uses the Source Code of T-Kernel 2.0 under T-License 2.2 granted by TRON Forum ([www.tron.org](http://www.tron.org)).

- Pioneer accepts no responsibility for data lost from an iPhone, even if that data is lost while using this product. Please back up your iPhone data regularly.

- Do not leave the iPhone in direct sunlight for extended amounts of time. Extended exposure to direct sunlight

- can result in iPhone malfunction due to the resulting high temperature.
- Do not leave the iPhone in any location with high temperatures.
- Firmly secure the iPhone when driving. Do not let the iPhone fall onto the floor, where it may become jammed under the brake or gas pedal.
- For details, refer to the iPhone manuals.
- Please note that the use of this accessory with an Apple product may affect wireless performance.
- Apple CarPlay, iPhone, iTunes, QuickTime, and Siri are trademarks of Apple Inc., registered in the U.S. and other countries and regions.
- Use of the Apple CarPlay logo means that a vehicle user interface meets Apple performance standards. Apple is not responsible for the operation of this vehicle or its compliance with safety and regulatory standards. Please note that the use of this product with iPhone, iPod, or iPad may affect wireless performance.
- Works with Siri through the microphone.
- App Store is a service mark of Apple Inc., registered in the U.S. and other countries and regions.
- IOS is a trademark or registered trademark of Cisco in the U.S. and other countries and is used under license.
- LTE is a trademark of ETSI.
- iDatalink, Maestro and iData are registered trademarks of Automotive Data Solutions Inc.

# Troubleshooting

If you have problems operating this product, refer to this section. The most common problems are listed below, along with likely causes and solutions. If a solution to your problem cannot be found here, contact your dealer or the nearest authorized Pioneer service facility.

## Common problems

**A black screen is displayed, and operation is not possible using the touch panel keys.**

- [Power OFF] mode is on.
  - Touch any button on this product to release the mode.

**Bluetooth operation does not work.**

- The power failed for the Bluetooth module of this product.
  - Turn the ignition switch to OFF and then to ON.
 If the error message is still displayed after performing the above action, please contact your dealer or an authorized Pioneer Service Station.

**Android device connection fails via Bluetooth wireless technology or Android Auto or using the PxLink app.**

- Delete this product from the paired devices list or Bluetooth connection history on your mobile device and delete your mobile device from the device list on this product, then retry connection.

## Problems with the AV screen

**The screen is covered by a caution message and the video cannot be shown.**

- The parking brake lead is not connected or the parking brake is not applied.
  - Connect the parking brake lead correctly, and apply the parking brake.
- The speed sensor detects that the vehicle is moving.
  - Park your vehicle in a safe place and apply the parking brake.

**No video output from the connected equipment.**

- The [AV Input] or [AUX Input] setting is incorrect.
  - Correct the settings.

**The audio or video skips.**

- This product is not firmly secured.
  - Secure this product firmly.

**No sounds are produced. The volume level will not rise.**

- Cables are not connected correctly.
  - Connect the cables correctly.

**The icon  is displayed, and operation is impossible.**

- The operation is not compatible with the video configuration.
  - The operation is not possible.

**The picture is stretched, with an incorrect aspect ratio.**

- The aspect setting is incorrect for the display.

- Select the appropriate setting for that image.

---

#### **iPhone cannot be operated.**

- The iPhone is frozen.
  - Reconnect the iPhone with the USB interface cable for iPhone.
  - Update the iPhone software version.
- An error has occurred.
  - Reconnect the iPhone with the USB interface cable for iPhone.
  - Park your vehicle in a safe place, and then turn off the ignition switch (ACC OFF). Subsequently, turn the ignition switch to on (ACC ON) again.
  - Update the iPhone software version.
  - Reconnect the iPhone via the Wi-Fi connection.
- Cables are not connected correctly.
  - Connect the cables correctly.

---

#### **Sound from the iPhone cannot be heard.**

- The audio output direction may switch automatically when the Bluetooth and USB connections are used at the same time.
  - Use the iPhone to change the audio output direction.

---

#### **No back camera image when the vehicle is in reverse.**

- The back camera input setting on the receiver is set to Off.
  - Change the back camera setting to On in the settings menu. (Refer to the System settings section of this manual to adjust.)
- The camera input may be loose or not connected.
  - Check the connection and make sure the male end of the camera is connected to the brown input on the back of the receiver. (Refer to the Quick start guide.)

- The reverse lead on the receiver may not be connected to the proper wire at the reverse lamp.
  - Check the connection and make sure that the violet/white lead of the receiver is connected to the lead whose voltage changes when the shift lever is put in reverse. (Refer to the Quick start guide.)

---

#### **A black screen displayed when the vehicle is in reverse, with no camera installed.**

- Back camera input is set to On.
  - Turn the setting to Off in the settings menu. (Refer to the System settings section of this manual to adjust.)

---

#### **Back image displayed when vehicle is not in reverse.**

- The camera polarity is not set properly in the Camera settings menu.
  - Review System settings section of this manual for steps to switch the camera polarity. Park in a safe place, then while keeping your foot firmly on the brake, put the vehicle in reverse, access the System settings menu, and change the camera polarity setting. Put vehicle back in park. (Refer to the System settings section of this manual to adjust.)

## **Problems with the phone screen**

---

#### **Dialing is impossible because the touch panel keys for dialing are inactive.**

- Your phone is out of range for service.
  - Retry after re-entering the range for service.
- The connection between the cellular phone and this product cannot be established.

- Perform the connection process.
- Of the two cellular phones connected to this product at the same time, if the first phone is dialing, ringing or a call is in progress, dialing cannot be performed on the second phone.
  - When the operation on the first of the two cellular phones is completed, use the switch devices key to switch to the second phone and then dial.
- Disconnect the smartphone from the cable, and wait until the smartphone cools down.
- More battery power was consumed than was gained from charging.
  - This problem may be resolved by stopping any unnecessary services on the smartphone.

## Problems with Application screen

---

### A black screen is displayed.

- While operating an application, the application was ended on the smartphone side.
  - Touch  to display the home menu screen.
- The smartphone OS may be awaiting screen operation.
  - Stop the vehicle in a safe place and check the screen on the smartphone.

---

### The screen is displayed, but operation does not work at all.

- An error has occurred.
  - Park your vehicle in a safe place, and then turn off the ignition switch (ACC OFF). Subsequently, turn the ignition switch to on (ACC ON) again.
  - When an Android device is connected, disconnect the Bluetooth connection from this product and then reconnect it.

---

### The smartphone was not charged.

- Charging stopped because the temperature of the smartphone rose due to prolonged use of the smartphone during charging.

# Error messages

When problems occur with this product, an error message appears on the display. Refer to the table below to identify the problem, then take the suggested corrective action. If the error persists, record the error message and contact your dealer or your nearest Pioneer service center.

## Common

### AMP Error

- This product fails to operate or the speaker connection is incorrect; the protective circuit is activated.
  - Check the speaker connection. If the message fails to disappear even after the engine is switched off/on, contact your dealer or an authorized Pioneer Service Station for assistance.

**Product overheat. System will be shut down automatically in 15 seconds. Restart the product by ACC-Off/On may fix this problem. If this message keeps showing up, it is possible that some problem occurred in the product.**

- The temperature of the main unit is too high.
  - Turn off the ignition switch (ACC OFF) then wait until the main unit temperature reaches low.

## SiriusXM® Satellite Radio

### Check Antenna

- The antenna connection is incorrect.

- Check the antenna connection. If the message fails to disappear even after the engine is switched off/on, contact your dealer or the nearest authorized Pioneer service center for assistance.

### Check Tuner

- The SiriusXM Connect Vehicle Tuner connection is incorrect.
  - Check the tuner connection and battery voltage. If the message fails to disappear even after the engine is switched off/on, contact your dealer or the nearest authorized Pioneer service center for assistance.

### No Signal

- The SiriusXM Connect Vehicle Tuner is having difficulty receiving the SiriusXM satellite signal.
  - Verify that your vehicle is outdoors with a clear view of the southern sky.
  - Verify that the SiriusXM magnetic mount antenna is mounted on a metal surface on the outside of the vehicle.
  - Move the SiriusXM antenna away from any obstructions.

### No Content

- TuneScan is not available.
  - Perform the operation with another preset channel.

### Channel Not Available

- The channel that you have requested is not a valid SiriusXM channel.
  - Visit [www.siriusxm.com](http://www.siriusxm.com) for more information about the SiriusXM channel lineup.

### Subscription Updated Press Enter to Continue

- This product has detected a change in your SiriusXM subscription status.
  - Touch [Enter] to clear the message. In the U.S.A., visit [www.siriusxm.com](http://www.siriusxm.com) or call 1-866-635-2349 if you have questions about

your subscription. In Canada, visit [www.siriusxm.ca](http://www.siriusxm.ca) or call 1-888-539-7474 if you have questions about your subscription.

### Channel Not Subscribed. Call SiriusXM to Subscribe.

- The channel that you have requested is not included in your SiriusXM subscription package.
    - Check the content of your SiriusXM subscription package.
- In the U.S.A., visit [www.siriusxm.com](http://www.siriusxm.com) or call 1-866-635-2349 if you have questions about your subscription package or would like to subscribe to this channel. In Canada, visit [www.siriusxm.ca](http://www.siriusxm.ca) or call 1-888-539-7474.

### Channel Locked Please Enter the Lock Code

- Locked by the radio Parental Control feature.
  - Release the channel lock.

### Memory Full

- The memory has become full while playback was paused.
  - Resume playback.

### Memory Nearly Full

- The memory has become nearly full while playback was paused.
  - Resume playback.

### There are no qualified TuneMix music channels in this band.

- There are no qualified TuneMix channels in this band.
  - Requires two or more qualified music channels to be stored as presets in the current band.

## USB storage device

### Error-02-9X/-DX

- Communication failed.
  - Turn the ignition switch OFF and back ON.
  - Disconnect the USB storage device.

- Change to a different source. Then, return to the USB storage device.

### Unplayable File

- There is no playable file in the USB storage device.
  - Check that the files in the USB storage device are compatible with this product.
- Security for the connected USB storage device is enabled.
  - Follow the USB storage device instructions to disable security.

### Skipped

- The connected USB storage device contains DRM protected files.
  - The protected files are skipped.

### Protect

- All the files on the connected USB storage device are embedded with DRM.
  - Replace the USB storage device.

### Incompatible USB

- The connected USB storage device is not supported by this product.
  - Disconnect your device and replace it with a compatible USB storage device.

### Check USB

- The USB connector or USB cable has short-circuited.
  - Check that the USB connector or USB cable is not caught in something or damaged.
- The connected USB storage device consumes more than maximum allowable current.
  - Disconnect the USB storage device and do not use it. Turn the ignition switch to OFF, then to ACC or ON and then connect a compliant USB storage device.

### HUB Error

- The connected USB hub is not supported by this product.
  - Directly connect the USB storage device to this product.

---

**No Response**

- This product cannot recognize the connected USB storage device.
  - Disconnect the device and replace it with another USB storage device.
- The USB connector or USB cable has short-circuited.
  - Check that the USB connector or USB cable is not caught in something or damaged.
- The connected USB storage device consumes more than maximum allowable current.
  - Disconnect the USB storage device and do not use it. Turn the ignition switch to OFF, then to ACC or ON and then connect a compliant USB storage device.
- The USB interface cable for iPhone has short-circuited.
  - Confirm that the USB interface cable for iPhone or USB cable is not caught in something or damaged.

---

**Audio Format not supported**

- This type of file is not supported on this product.
  - Select a file that can be played.

---

**Apple CarPlay**

---

**Connection failed.**

- Communication failed and the system is trying to connect.
- Wait for a while. Then, perform the actions below if the error message is still displayed.
  - Restart the iPhone.
  - Disconnect the cable from the iPhone, and then connect the iPhone again after a few seconds.
  - Turn the ignition switch to OFF and then to ON.

---

**Please attach the GPS antenna in order to use Apple CarPlay over Wireless.**

- This unit cannot properly detect the GPS signal from the GPS antenna.

- Check the GPS antenna installation and connection. For details about the connection and installation, refer to the Quick start guide.

---

**The speed sensor is disconnected. Please attach it.**

- The speed sensor cannot detect any signal.
  - Check the speed signal cable connection. For details about the connection, refer to the Quick start guide.

---

**Please attach the GPS antenna and the speed sensor in order to use Apple CarPlay over Wireless.**

- This unit cannot detect the GPS signal from the GPS antenna and the speed signal from the speed sensor.
  - Check the connection and installation for both. For details about the connection and installation, refer to the Quick start guide.

If the error message is still displayed after performing the above action, please contact your dealer or an authorized Pioneer Service Station.

---

**Android Auto**

---

**To use Android Auto, please check the screen of your Android phone when it is safe to do so.**

- The time set in the smartphone is not correct.
  - Set the correct time.

If the error message is still displayed after performing the above action, please contact your dealer or an authorized Pioneer Service Station.

---

**Bluetooth pairing failed.**

- The Bluetooth pairing failed for some reasons.
  - Pair this product with the device manually.

---

**To use Android Auto, please stop your car and check your Android phone.**

- The default settings are displayed on the screen of the Android Auto compatible device or images are not output from the Android Auto compatible device.
  - Park your vehicle in a safe place, and follow the instructions displayed on the screen. If the error message is still displayed after performing on-screen instructions, please reconnect the device.

# Appendix

## How to reset the main unit

Reset the main unit in the following cases:

- When it is not operating properly
- When the screens are not being displayed properly

### 1 Touch and simultaneously for 5 seconds or longer.

The main unit restarts.

#### NOTE

Even if the main unit is reset, the contents and settings registered in the main unit are not erased.

## Using app-based connected content

### Important

Requirements to access app-based connected content services using this product:

- Latest version of the Pioneer compatible connected content application(s) for the smartphone, available from the service provider, downloaded to your smartphone.
- A current account with the content service provider.
- Smartphone Data Plan.

Note: if the Data Plan for your smartphone does not provide for unlimited data usage, additional charges from your carrier may apply for accessing app-based connected content via 3G, EDGE and/or LTE™ (4G) networks.

- Connection to the Internet via 3G, EDGE, LTE (4G) or Wi-Fi network.
- Optional Pioneer adaptor cable connecting your iPhone to this product.

### Limitations:

- Access to app-based connected content will depend on the availability of cellular and/or Wi-Fi network coverage for the purpose of allowing your smartphone to connect to the Internet.
- Service availability may be geographically limited to the region. Consult the connected content service provider for additional information.
- Ability of this product to access connected content is subject to change without notice and could be affected by any of the following: compatibility issues with future firmware versions of smartphone; compatibility issues with future versions of the connected content application(s) for the smartphone; changes to or discontinuation of the connected Content application(s) or service by its provider.
- Pioneer is not liable for any issues that may arise from incorrect or flawed app-based content.
- The content and functionality of the supported applications are the responsibility of the App providers.
- In WebLink®, Apple CarPlay and Android Auto, functionality through the product is limited while driving, with available functions determined by the App providers.
- Availability of WebLink®, Apple CarPlay and Android Auto functionalities is

determined by the App provider, and not determined by Pioneer.

- WebLink®, Apple CarPlay and Android Auto allow access to applications other than those listed (subject to limitations while driving), but the extent to which content can be used is determined by the App providers.
- Connected services require connection to a wireless network via a compatible iPhone or Android smartphone device, which is subject to your wireless carrier's terms of service and data plan. Review your wireless service and data plan terms for any applicable restrictions, limitations and charges. Ability to use such services will depend on network availability and carrier terms of service. Availability of non-Pioneer content and services, including apps and connectivity, may change without notice due to changes in operating systems, firmware or app versions; changes to, restrictions on or discontinuation of the service or service plans; non-Pioneer hardware changes; or other events.

## Notice regarding video viewing

Remember that use of this system for commercial or public viewing purposes may constitute an infringement on the author's rights as protected by the Copyright Law.

## Using the LCD screen correctly

### Handling the LCD screen

- When the LCD screen is subjected to direct sunlight for a long period of time, it will become very hot, resulting in possible damage to the LCD screen. When not using this product, avoid exposing it to direct sunlight as much as possible.
- The LCD screen should be used within the temperature ranges shown in Specifications on page 107.
- Do not use the LCD screen at temperatures higher or lower than the operating temperature range, because the LCD screen may not operate normally and could be damaged.
- The LCD screen is exposed in order to increase its visibility within the vehicle. Please do not press strongly on it as this may damage it.
- Do not push the LCD screen with excessive force as this may scratch it.
- Never touch the LCD screen with anything besides your finger when operating the touch panel functions. The LCD screen can scratch easily.

### Liquid crystal display (LCD) screen

- If the LCD screen is near the vent of an air conditioner, make sure that air from the air conditioner is not blowing on it. Heat from the heater may break the LCD screen, and cool air from the cooler may cause moisture to form inside this product, resulting in possible damage.

- Small black dots or white dots (bright dots) may appear on the LCD screen. These are due to the characteristics of the LCD screen and do not indicate a malfunction.
- The LCD screen will be difficult to see if it is exposed to direct sunlight.
- When using a cellular phone, keep the antenna of the cellular phone away from the LCD screen to prevent disruption of the video in the form of disturbances such as spots or colored stripes.

### Maintaining the LCD screen

- When removing dust from or cleaning the LCD screen, first turn this product off and then wipe the screen with a soft dry cloth.
- When wiping the LCD screen, take care not to scratch the surface. Do not use harsh or abrasive chemical cleaners.

### LED (light-emitting diode) backlight

A light emitting diode is used inside the display to illuminate the LCD screen.

- At low temperatures, using the LED backlight may increase image lag and degrade the image quality because of the characteristics of the LCD screen. Image quality will improve with an increase in temperature.
- The product lifetime of the LED backlight is more than 10 000 hours. However, it may decrease if used in high temperatures.
- If the LED backlight reaches the end of its product lifetime, the screen will become dimmer and the image will no longer be visible. In that case, please

consult your dealer or the nearest authorized Pioneer Service Station.

*Register your product at*

**<https://www.pioneerelectronics.com/PUSA/>**

*in Canada* **<https://www.pioneerelectronics.ca/POCEN/>**

## **PIONEER CORPORATION**

28-8, Honkomagome 2-chome, Bunkyo-ku,  
Tokyo 113-0021, Japan

## **PIONEER ELECTRONICS (USA) INC.**

P.O. Box 1720, Long Beach, CA 90801-1720, U.S.A.  
TEL: (800) 421-1404

## **PIONEER EUROPE NV**

Haven 1087, Keetberglaan 1, B-9120 Melsele, Belgium/Belgique  
TEL: (0) 3/570.05.11

## **PIONEER ELECTRONICS ASIACENTRE PTE. LTD.**

No. 2 Jalan Kilang Barat, #04-02, Singapore 159346  
TEL: 65-6378-7888

## **PIONEER ELECTRONICS AUSTRALIA PTY. LTD.**

Unit 13, 153-155 Rooks Road, Vermont, Victoria, 3133 Australia  
TEL: (03) 9586-6300

## **PIONEER ELECTRONICS DE MÉXICO S.A. DE C.V.**

Bldv. Manuel Ávila Camacho #118, Piso 12, Lomas de Chapultepec,  
Alcaldía Miguel Hidalgo C.P. 11000, Ciudad de México  
Tel: 52-55-9178-4270

先鋒電子（香港）有限公司  
香港九龍長沙灣道909號5樓  
電話：852-2848-6488

© 2024 PIONEER CORPORATION

<KKYZ24G>

<OPM\_DMHWT6000NEXUC\_EN\_A> UC