



AGA RANGEmaster

Aga eR7 Field Service Manual USA and Canada



The information detailed in this guide applies to the Aga eR7 electric cooker, at all times the service technician **MUST** apply their competencies and ensure the appliance is left safe for continued use, should the appliance fail any test then engineering judgement must be applied as to whether the appliance can be left operational.



Contents

Product overview	3
Cooking zones	4
The capacitance touch control panel.....	5
General information and power sharing	6
Power sharing around the cooking zones.....	6
Power supply connections	7
Essential tools	8
Torque screwdriver settings	8
Fault diagnostics overview.....	9
Connecting the TEK Vision software	10
Fault diagnostics	11
TEK Vision opening screen with laptop connected.....	12
TEK Vision diagnostics screen with no errors present.....	13
TEK Vision diagnostics screen with errors present.....	14
Explanation of error codes and advice what action to take	16
To reset the PCB after a fault condition.....	18
TEK Vision software	18
The logging screen tab	19
The Firmware screen tab	19
The graph screen tab	20
Engineer's diagnostic handset - (AE4M280323)	21
Using the engineers hand set:	21
Removal and replacement of major components	22
Main PCB:.....	22
Boiling plate and Simmer plate:.....	23
Customers Touch Control:	24
Front Plate:.....	24
Oven doors:.....	25
Touch control unit and thermocouples:	26
Oven elements:.....	27
AGA Hotcupboard eR7 150	28
Essential Parts List.....	28
Wiring schematic. (North America)	29
AGA Hotcupboard	30
AGA INSULATING LID HINGE ASSEMBLY (Introduced 2005).....	34

Product overview

The Aga Er7 is an all-electric cooker that replaces the Aga Total Control it offers new enhanced features with everyday radiant heat and has independently controlled hotplates and ovens, features include:

- Capacitance touch-screen control panel with LED lighting.
- Electronic temperature control of the cooking zones to give accurate temperature control.
- LED heat indicators for a clear indication of when the cooker is heating up and has reached the required temperature.
- The Boiling plate 330°C (626°F) and the Simmer plate 200°C (392°F) are pre-programmed to get to their respective temperatures.
- The Roast Oven has five temperature settings R9, R8, R7, R6 and B4.
- The Baking Oven has four temperature settings B1, B2, B3 and B4.
- The Simmer Oven has one pre-set temperature.

Cooking zones

Below is a picture showing the different cooking zones on the Aga eR7 100. All ovens and both hotplates are independently controllable using the control panel located behind the top left hand control door.



Aga eR7 150



The Aga er7 150 has a hotcupboard attached to the parent Aga, the hotcupboard does not use the electronic controls that the eR7 utilises and is supplied either with a warming plate or a single zone induction hob on the top.

The capacitance touch control panel

Like the classic Aga cooker design the Aga eR7 has a Boiling plate and a Simmer plate. Each hotplate is individually temperature controlled and pre-programmed within the main PCB

Each of the three ovens have their own pre-set temperature settings. When using the roasting and baking ovens, different temperatures can be selected to suit the customer's needs.

The customers control panel is located behind the top left hand door, we recommend engineers familiarise themselves with the users instructions on the operational modes of the cooker so they understand how the cooker works.

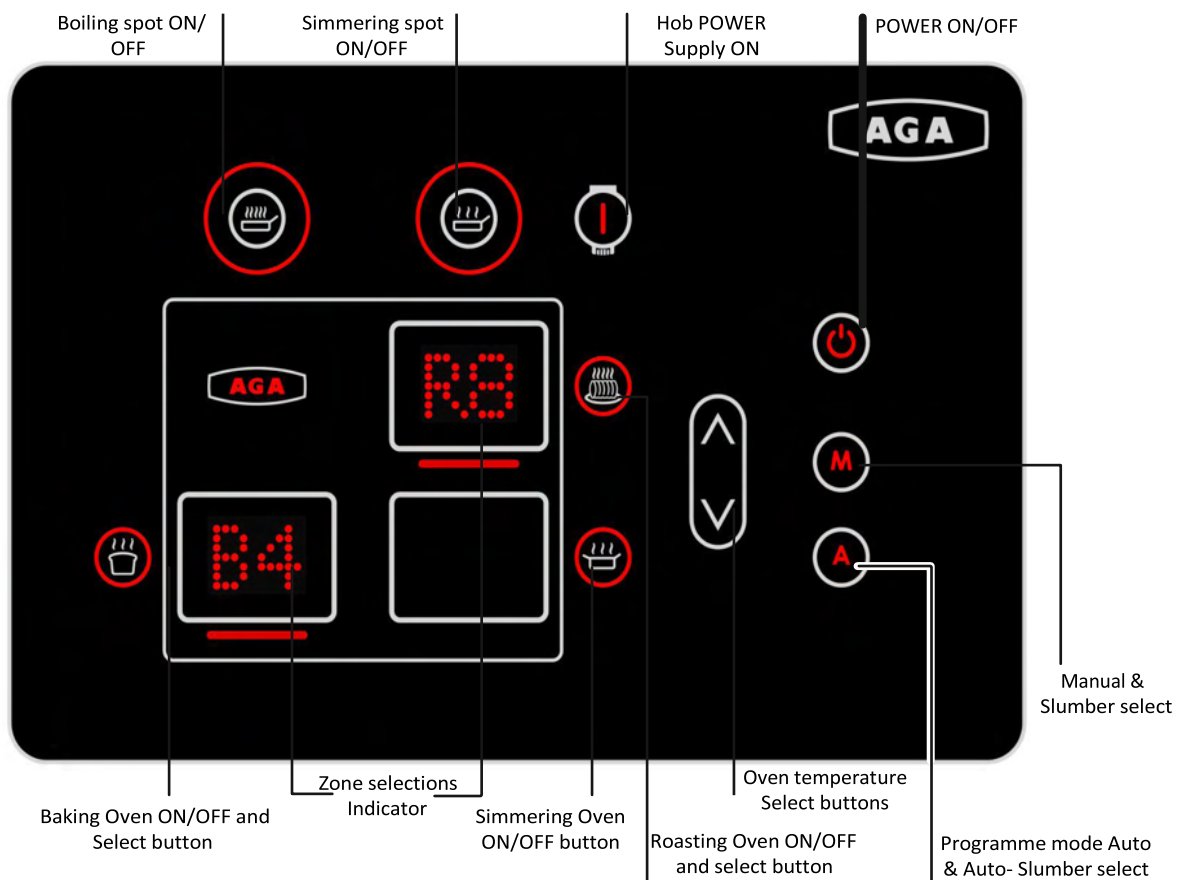

General information and power sharing

The Aga e7 does not need to be regularly serviced.

DO NOT ALTER or MODIFY the appliance.

The appliance warranty does not cover commercial use.

Please refer to the Aga e7 cooker installation instructions for specific information regarding appliance dimensions, clearances, electrical requirements and oven venting etc.

Installation instructions and videos are available to view at www.agaliving.com/

Important Note

BEFORE CARRYING OUT WORK ON THE APPLIANCE, THE POWER SUPPLY MUST BE ISOLATED AND TESTED FOR SAFE ELECTRICAL ISOLATION.

The main cooker assembly is electrically tested before leaving the factory.

The cooker is controlled by a PCB which is located in the base of the cooker.

Always inspect the cooker before any work is carried and notify the customer of any existing damage.

The customer's capacitance touch user panel is connected to the main PCB by a communication cable which is routed within the cooker.

The cooker has 5 cooking zones: Boiling plate, Simmer plate, Roast oven, Baking oven and Simmer oven.

The boiling and simmer plate use the same 2.5kw circular element and the ovens have the same rectangular 2.5kw element, the roasting and baking oven have 2 elements one in the top and one in the base whereas the simmer oven has only one element in the base.

All element resistances will be approximately 18-22 ohms.

Power sharing around the cooking zones.

The PCB within the e7 is programmed to share the power supply around the different cooking zones. This means that despite the zones totalling around 17.5kW, which would have an approx. current draw of 76amps only a 30amp supply is required. This is achieved by the programme only allowing three elements to be active at any time.

The programme works in a priority order meaning that if all zones are turned on together the boiling and simmering plates will always achieve 100% power initially, with the roasting oven's two elements alternating on / off to achieve the desired temperature. This means that at any one time there are only three elements on at the same time.

Once a zone reaches temperature the power is then shared to another zone with a lower set temperature. This varies automatically depending on the chosen settings.

Power supply connections

The range must be supplied with a 240V 60Hz power supply and connected to an individual, properly grounded branch circuit protected by a circuit breaker, at 240V it has a maximum load of 30 amps.

The electric connection must be done by a licensed electrician.

The Aga Er7 cooker leaves the factory set up for connection to a power supply, the power cable and standard four (4) prong type 14-50p plug are pre connected at the factory.

The picture below shows the power cable (not connected) and the main PCB pulled out of its position within the cooker showing the electrical connections

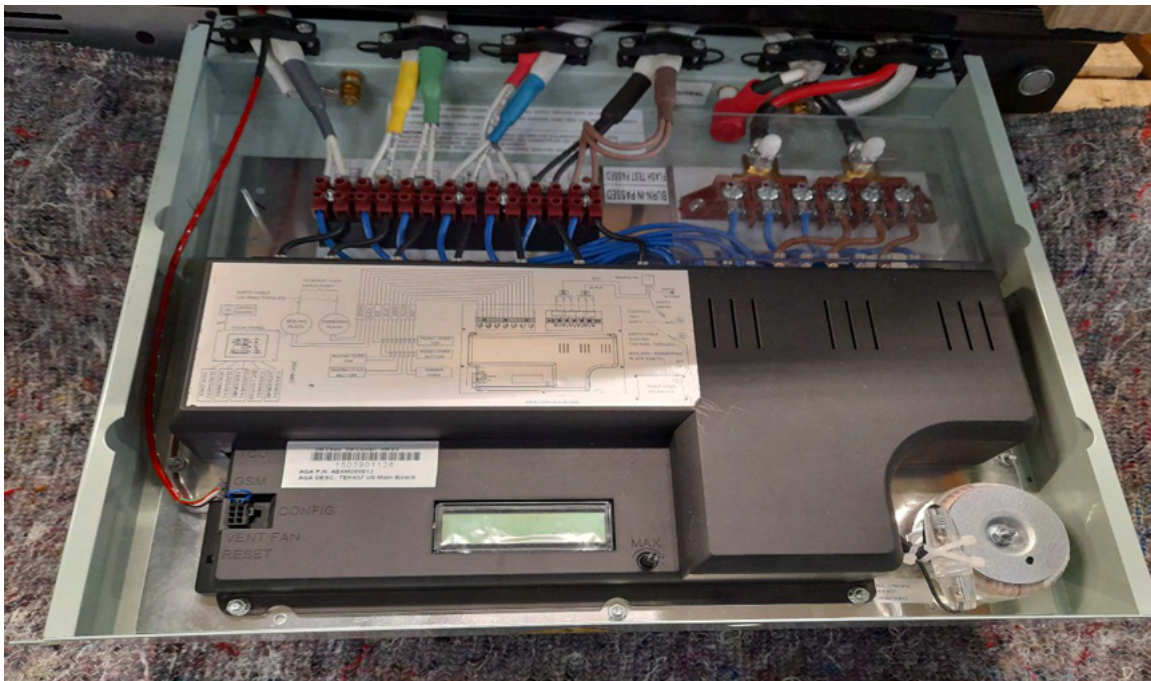

Essential tools

Before carrying out work on the appliance, the power supply MUST be isolated and tested for safe electrical isolation.

Always protect the cooker and work area before carrying out any work on the appliance, and always inspect the cooker for any existing damage before starting work.

When undertaking maintenance work on this appliance, the engineer should ensure the following tools are available

- Multi meter
- Clamp meter
- Insulation resistance tester
- Tool kit
- Torque driver with screwdriver bits
- Laptop with the TEK Vision software installed.
- TEK Vision connection key - (AE4M280824)
- Torque setting chart
- Hob support bars - (AE4M280399)

The electrical connections on the Aga Er7 must be tightened by the use of a torque screwdriver, please see the table on the next page for the relevant settings.

Torque screwdriver settings

Torque Setting NM	Product	AREA
2	Er7	Oven element sub assembly
0.8 (80 cNm) Initial connection. 0.6 (60 cNm) Retighten.	Er7	14 way terminal block connection on both PCB and element sides
2	Er7	Mains supply cable to trident (NUT)
2	Er7	Trident onto mains terminal block
0.6 (60 cNm)	Er7	Vent fan terminal block
0.65 (65cNm)	Er7	Cable clamps
1.0 + 0.2 / - 0.0	Er7	Hotplate
0.8	Er7 150	Terminal Connections

Fault diagnostics overview

The Aga Er7 control system is capable of detecting a range of conditions that have been pre-determined as fault conditions. Error codes are generated when an error condition is detected, the code signifies the type of error and the zone(s) affected, the codes are stored in the main PCB and can be reviewed at any time after the error has occurred. The codes are stored in two locations, a permanent **fault count** accessed via the PC interface and a temporary **fault log** which can be accessed via the PC interface or via the digital display on the main PCB. The PC interface requires the Field engineers test software referred to as **TEK Vision** and a **TEK Vision Interface Key**.

The temporary **fault log** is cleared each time the PCB is manually reset via the reset button on the main PCB, The permanent **fault count** cannot be cleared. **Ensure temporary error codes are accounted for before resetting the PCB.**

Errors are grouped into two categories Blocking and locking errors, both Locking and blocking errors will disable the output to a zone showing an error condition.

The five heat zones are, Hotspot (Boiling plate), Simmer plate, Roast oven, Bake oven and Simmer oven.

Blocking Errors: Certain error codes when recognised within the control system will block, a reassessment of the fault condition will be conducted periodically, and if the error is still present after the fourth assessment the controls will lock and permanently disable that zone and will require a repair and a manual reset to clear the error status. If a blocking error occurs four times in a 24hr period it will lock and disable the zone.

Locking Errors: Some error conditions will go straight to locked on the first detection of the error condition. These error codes also cannot be cleared without external intervention.

To clear the error condition the reset button has to be used, cycling the power will not reset the controls and does not clear the locked condition.

Error codes can be further sub divided into types and these are listed below:

Zone overheat errors, Thermocouple differential errors, Thermocouple open circuit errors, Triac errors, Relay errors, Open channel errors, Full power time out errors, User panel overheat errors.

The full fault code list can be read further on in this document.

Connecting the TEK Vision software

The below picture shows how the laptop is connected to the Tek PCB, the USB end fits into the laptop and the other end is connected to the GSM port on the PCB, this connector has a spring type clip on the end which will need to be pushed to release and remove.

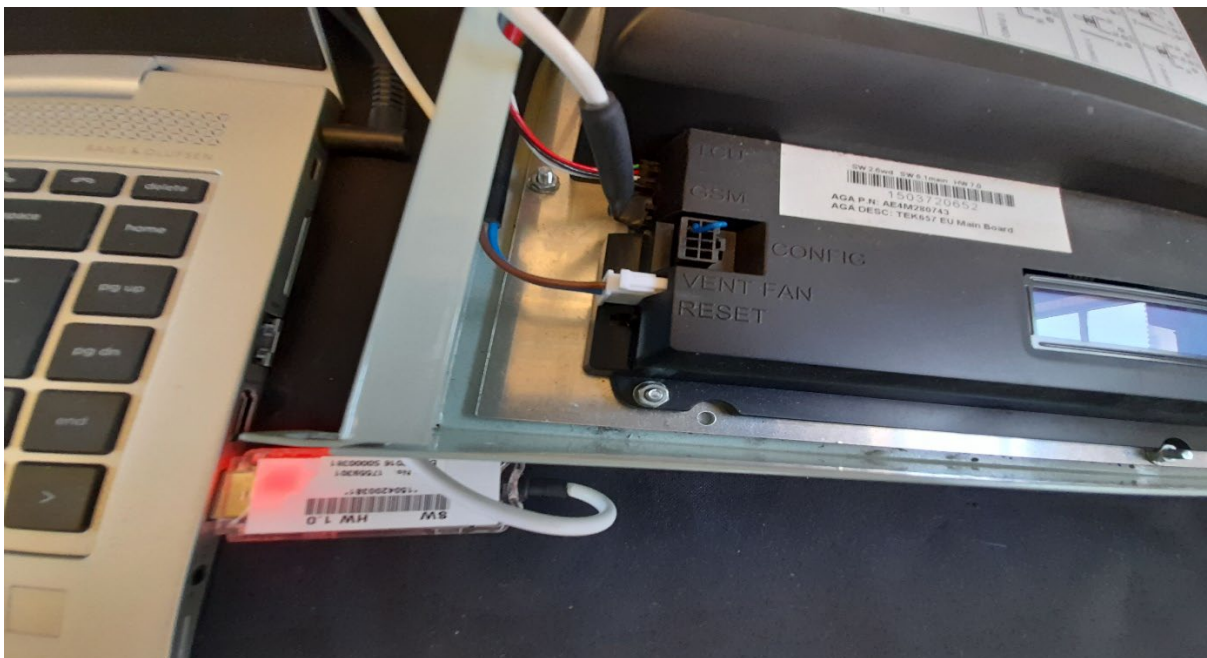

Fault diagnostics

The e7 AGA's electronic system has a built in diagnostic programme which will advise if an issue has been detected. Most faults will be shown either by the zone display lights rapid flashing or an error code either being displayed on the cookers display screen /customers handset screen.

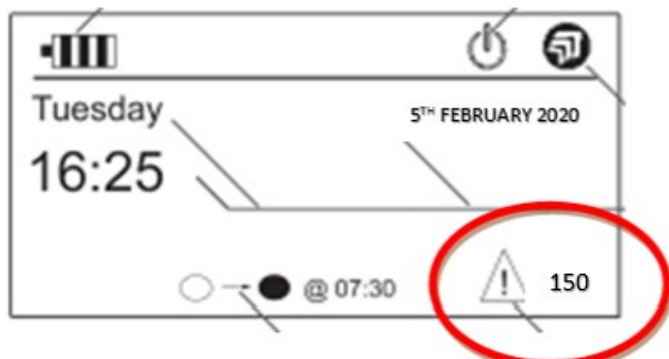

HANDSET DISPLAY ERROR CODE SHOWN HERE WITHIN THE RED CIRCLE

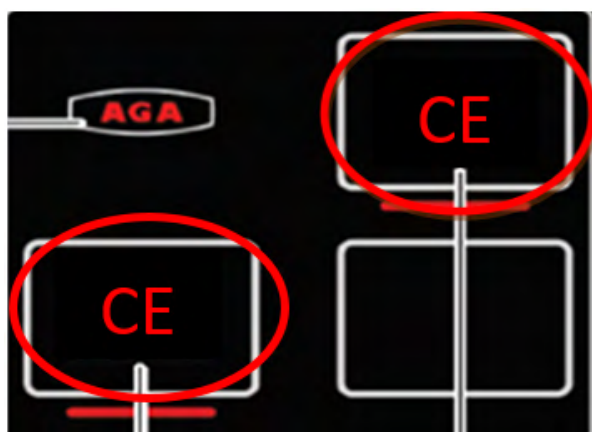

COOKER DISPLAY ERROR CODE WILL BE SHOWN WITHIN THE TEXT WINDOW ON THE DISPLAY SHOWN HERE WITHIN THE RED CIRCLE. THIS WILL NORMALLY CONSIST OF TWO LETTERS

When a customer reports a new issue, the error code must be obtained before any action is taken. This will assist with a first time resolution wherever possible.

The customer's handset error codes give an initial indication of the issue being experienced and can be used to assist with a first time resolution. They should be requested at the time the fault is reported by the customer

If the customer's user panel display shows an error code it will be one of the three below:

- **Error code FE:** Touch panel microcontroller unresponsive or malfunctioned. A reboot may resolve the issue, if the fault is still visible after the reboot, the panel will need to be investigated and possibly replaced.
- **Error code VE:** Main controller firmware version incompatible. PCB with 6.1 or higher softer is required, change the PCB.
- **Error code CE:** No response from main controller. Check the connection and condition of the COMS cable and the sockets on the PCB and facia.

Should the customer report an error code on their e7 AGA and you are required to visit site to investigate, then the Tek vision software must be connected using the connection key and your laptop. This software will give you full visibility of any faults which have occurred previously and also which are currently present, aiding the correct fault diagnosis.

TEK Vision opening screen with laptop connected

When using the Tek Vision software ensure the cooker power on /off button is on.

Below is a step by step guide to navigating the tek vision software. With the cookers PCB connected to your laptop using the appropriate connection key, double click the Tek Vision icon, Tek Vision will open and the below will be shown on your laptop screen , the default screen is the set up screen.

To start using the diagnostics first click the 'serial port' option and select 'open port' as shown below.

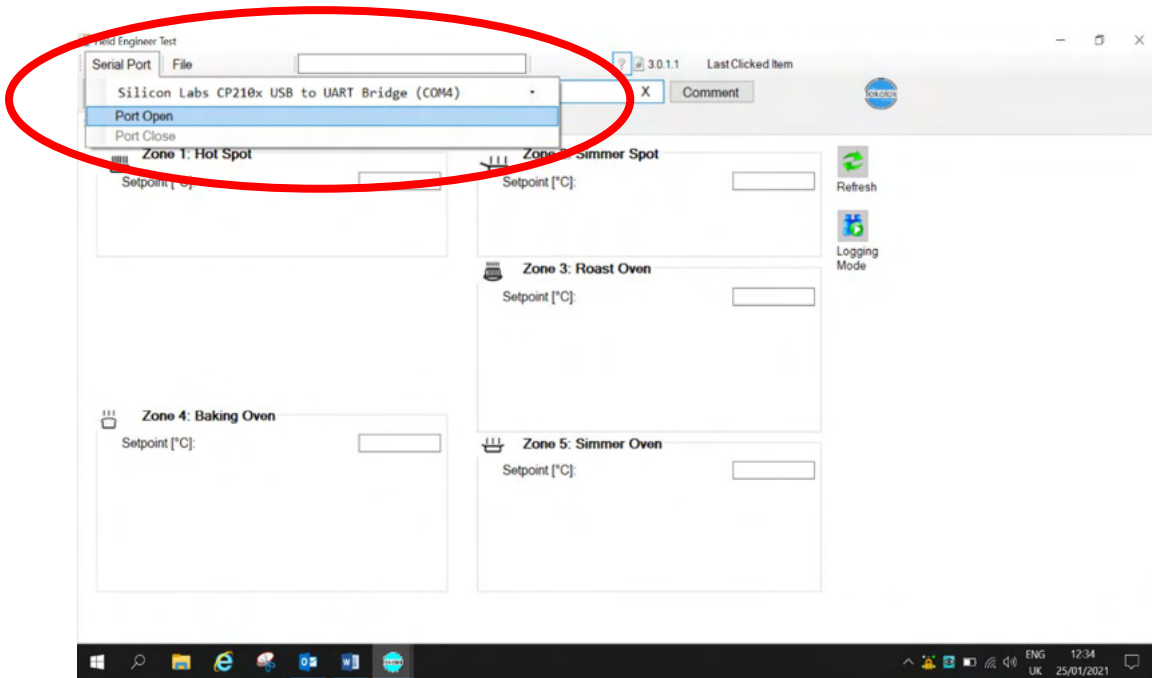

This will then open the set up screen which shows the correct pre-set temperatures for each cooking zone. This is shown in the picture below. This will be the set up tab on the screen

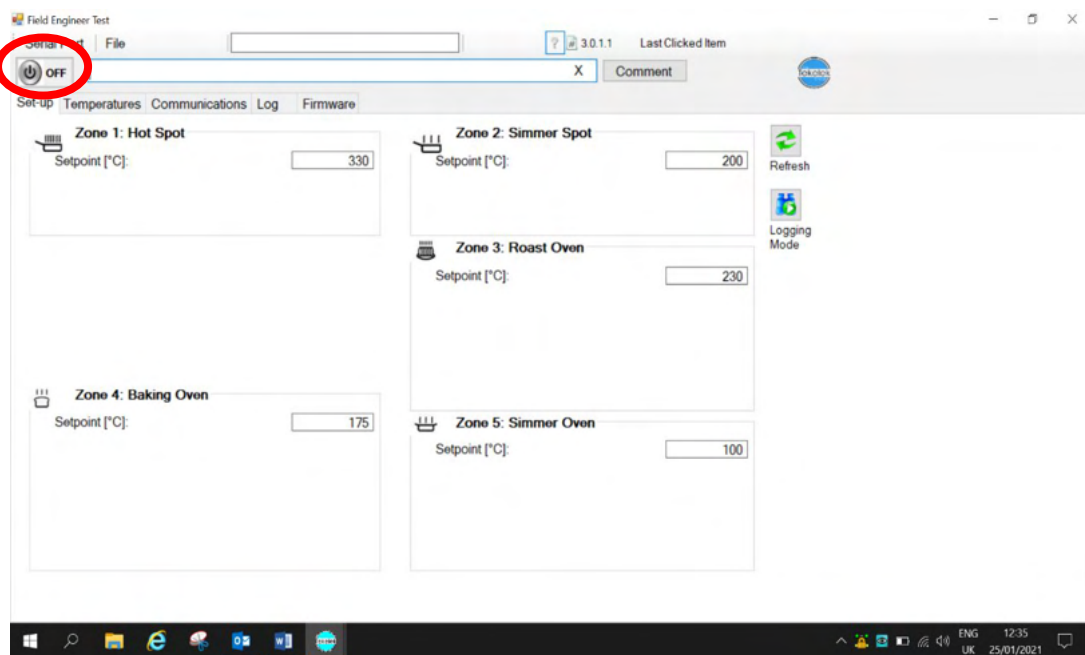

TEK Vision diagnostics screen with no errors present

Below is the temperature tab which shows the cooker working in real time and you will see that each zone shows the current temperatures recorded by the internal thermocouples and also in red it shows if any errors are currently present. Below is a picture showing the screen with no errors present and all zones are turned off.

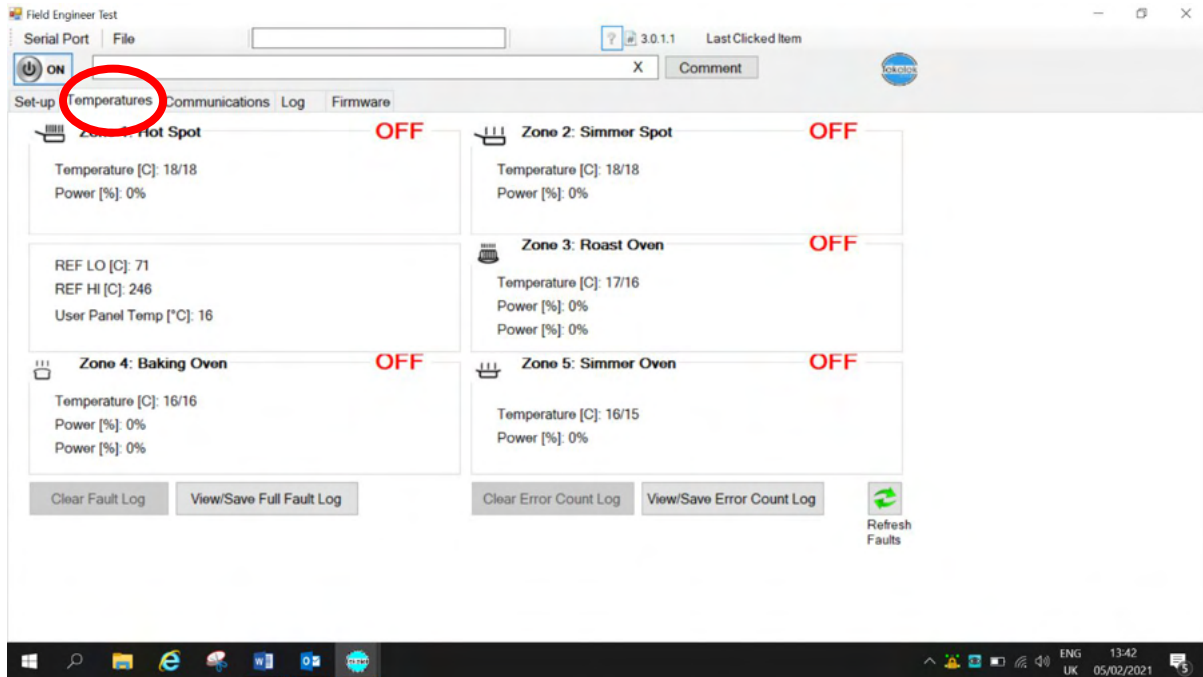

To view the full error log, press the '**view/save error count log**' button on the bottom right corner of the screen. This will then open a pop up window which will show all the error codes along with the time and date and the number of times the fault has occurred . This box will clear when the PCB is reset.

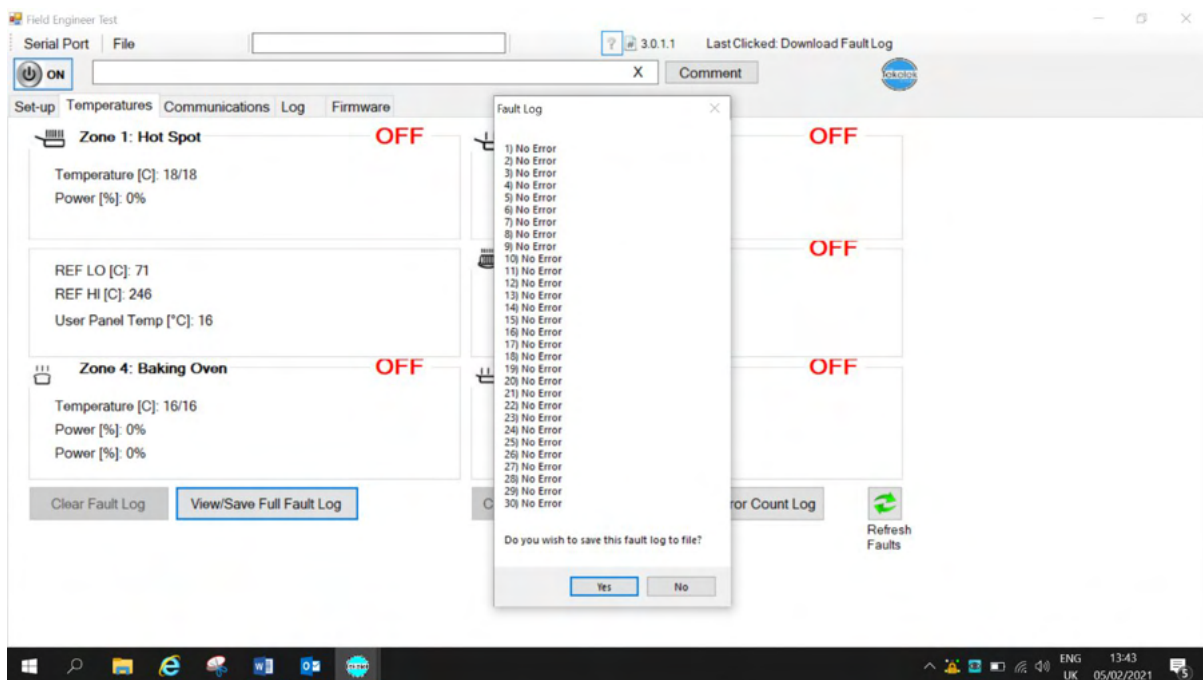

TEK Vision diagnostics screen with errors present

Below is an example of the screen with a fault showing in red. This is showing a 130 error code on the hotspot.

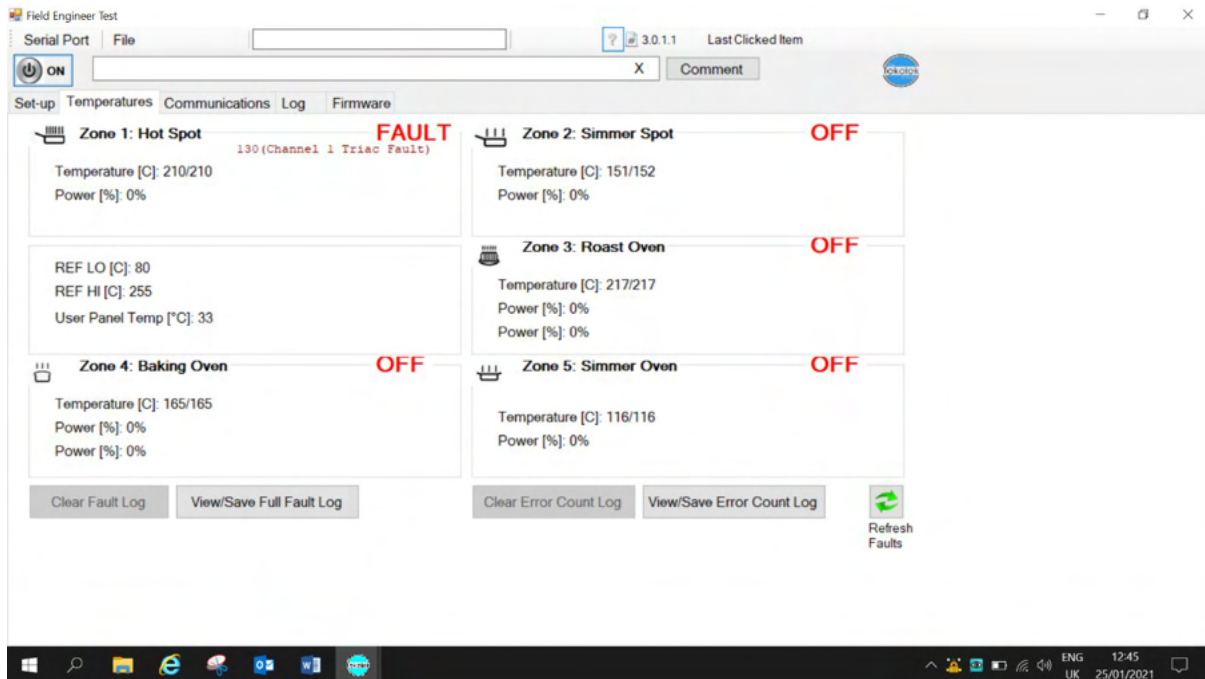

By pressing the 'view/save error count log' button this time, you can now see the number of times the 130 error code has occurred (4 times) along with any other previous errors. This box is the error code history of the PCB and will not change when the PCB is reset.

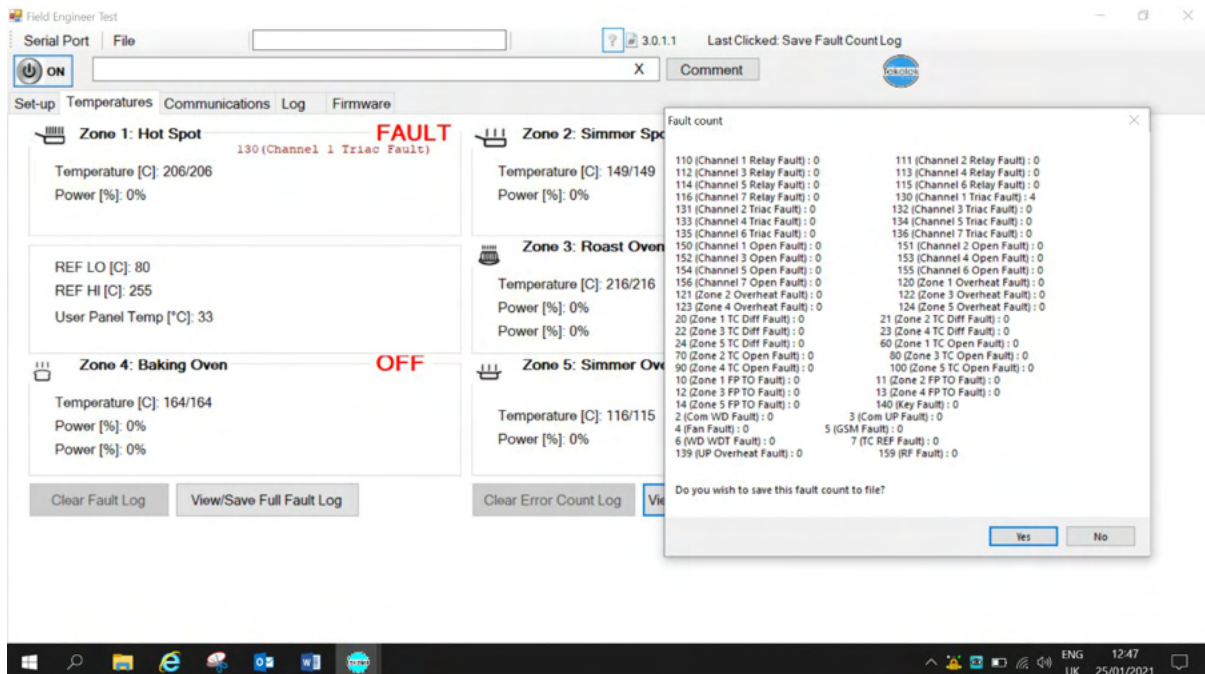

You will see above the fault count pop up box gives you the option to save the fault count to file. This must be saved and kept safe on every occasion a fault is found. This may be required as any fault diagnostic discussion with AGA.

To save the file, click the yes button and follow the instructions to save the file directly onto your laptop as shown below.

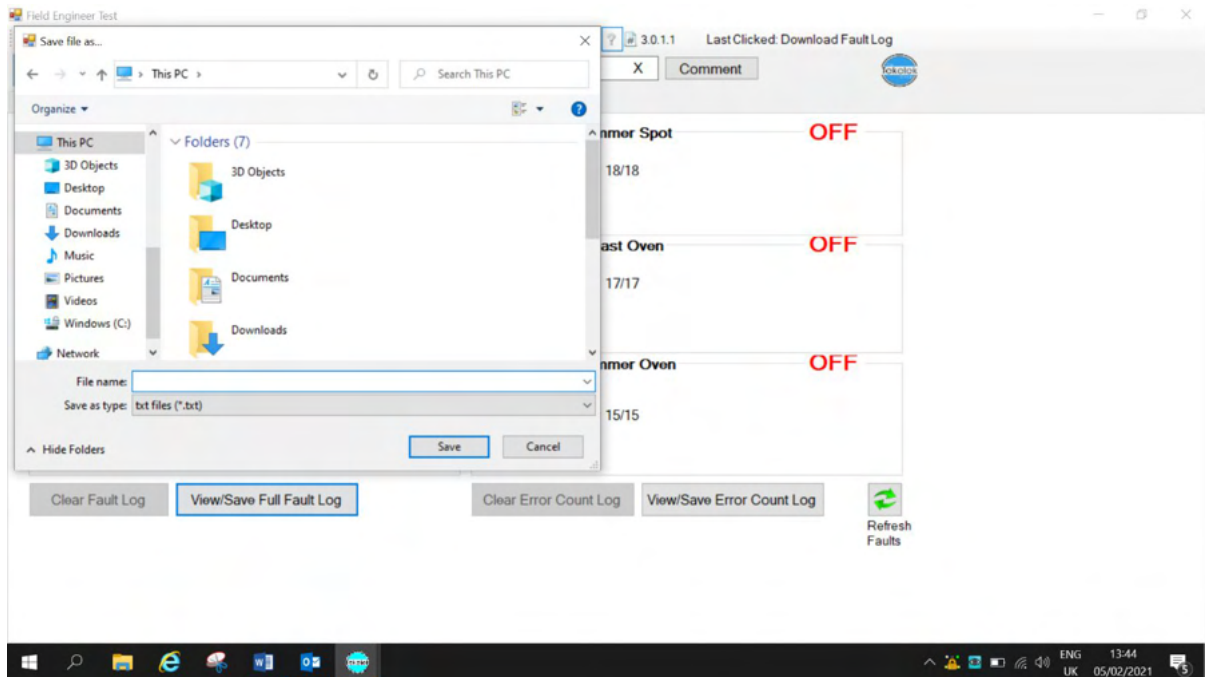

Once the fault is cleared and with all zones on you should be able to see the below screen on the laptop showing that all zones are turned on and the cooker is heating up normally and power sharing, it also gives information on,thermocouple temperatures,power being used and the user panel temperature.

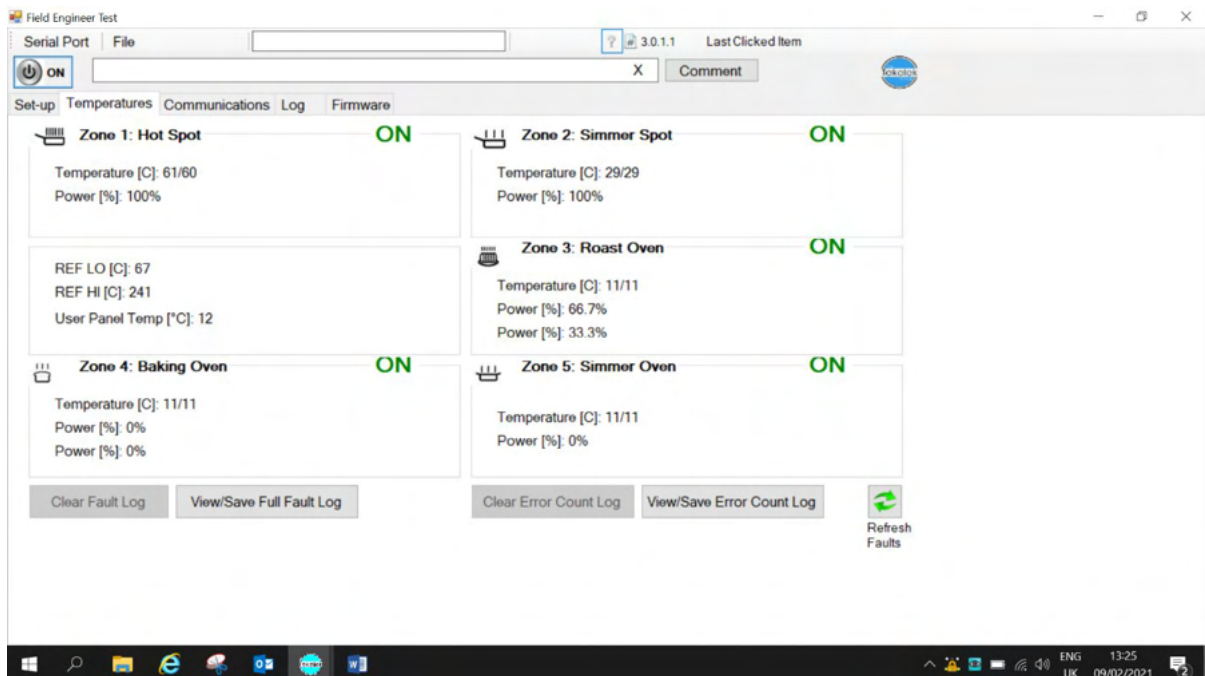

Explanation of error codes and advice what action to take

Error Code	Zone Affected	Description	Action
002	All	Com WD Fault	Reset and log, if recurring then PCB may be required
003	All	Com WD Fault	Check communication cable connections and continuity of cable, reconnect, reset and test
004	N/A	N/A	Not used
005	N/A	N/A	Not used
006	All	WD WDT Fault	Reset and log, If recurring then PCB may be required.
007	All	TC Ref Fault	Reset and log. If recurring then TCU may be required
010-014	All	Full power time out	Customer education, check position of thermocouple.
020 - 024	All	T/Couple Differential	Exchange Thermocouple
060 – 100	All	T/Couple open circuit	Exchange Thermocouple
110 – 116	All	Relay Short circuit	Reset and log. If recurring then PCB may be required
120 – 124	All	Cooking Zone Overheat Error	Thermocouple cross connected on user control
130 – 136	All	Triac Fault	Check connections of element, check resistance of element (18-20Ω) If element open circuit replace element. If element resistance correct and software correct version then replace main PCB.
139	All	User Panel Overheat	Excessive temperatures recorded, check door seals, doors left open lack of insulation etc.
140	All	Configuration Key Fault	No Key fitted, wrong key in relation to phase of electrical supply.
150 – 156	All	Relay Open circuit	Reset and Log. If recurring then PCB may be required
159	Handset	RF Fault	Fault with receiver not communicating with PCB

Important Note

Please refer to the notes below to assist you with your diagnosis of any error codes recorded.

007: Error 7 will occur if the user panel PCB is unable to process thermocouple measurements requiring the user panel to be replaced.

010 - 014: Full power time out - A full power time out is a safety feature implemented to show the cooking zone is taking too long to reach it's expected temperature.

Full power time out errors may be caused by the way the cooker is being operated. The following can be causes, however this list is not exhaustive:

- Heat up time not allowed before use
- Doors left open
- Oversized pans
- Overly full pans
- Cold plain shelf left in the simmer oven while heating up

020 – 024: T/Couple differential - Use engineers handset / laptop software to monitor temperature of thermocouples.

060 – 100: T/Couple open circuit - Check the thermocouple with a multimeter. Please remember duplex thermocouples are used, so there are 4 wires on the plug, each thermocouple has a one green and one white conductor, so test across the green and white conductor with the multimeter probes. If open circuit exchange thermocouple. Check thermocouples are plugged fully in to user control panel.

****Note****

Instances of Thermocouples returned for testing have shown they test ok at room temp but drift apart or go open circuit at higher temperatures. Please ensure you rule this out.

110 - 116: Relay short circuit - Reset PCB and Log. If recurring then PCB may be required.

120 - 124: Cooking Zone Overheat Error - Check thermocouples are not cross connected on back of user control panel, visual Identification of where the thermocouples plug into are behind user control panel.

130 - 136: Triac Fault - Check connections of element circuit showing a triac error at element terminals, check resistance of element (18 – 20 Ω) if the element is open Circuit, replace the element. If the element resistance is correct and software version is correct then replace main PCB.

User Panel Overheat - Excessive temperatures can be caused by baking oven door left open or not fitting correctly, door seal defective (leaking heat).Plugs missing in thermocouple conduits. Towels etc. being draped over the control panel door.

Configuration Key Fault - No configuration key fitted to board or wrong key in relation to the phase of electrical supply the cooker is connected to. In addition, when controls are in standby it is possible to see a display of the configuration key compared to the connected phase (s) supply. See TB 30.01.14.

150 - 156: Relay Open Circuit - Reset and Log. If recurring then PCB may be required.

To reset the PCB after a fault condition

Press and hold the reset button located on the front left hand side of the PCB.



Customers should not be instructed on how to reset the PCB.

The main PCB screen will first display “clearing locks” it’s important to keep pressing the reset button until the screen displays “system reset.”

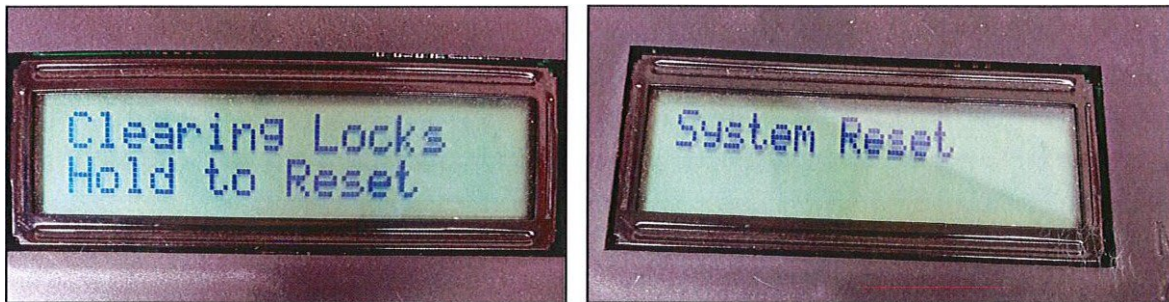

The screen will then display FW (Firmware) version followed by Stand- by.

The reset procedure is now complete, the controls will have gone into stand – by and all error codes in the temporary fault log will be cleared, the permanent fault log will not be cleared by a reset.

Note: Occasionally the reset procedure may not clear an error on the first attempt so a second or third attempt may be necessary.

TEK Vision software

There are **3** other screens within the TEK Vision Software that are useful to a field technician. The communication tab is not used by service technicians.

The logging screen tab

The TEK Vision software has an in built data logger, which gives information on all temperatures within the various zones, % of power the various channels are receiving and any fault codes that appear, the log updates around every 5 seconds, as soon as the Tek vision software is opened the system starts to log, if the system has to be reset the log will restart when this has been carried out.

Time	Minutes	UP Temp	Hot Plate	Simmer Plate	Roast Oven	Bake Oven	Simmer Oven	Channel 1 (%)	Channel 2 (%)	Channel 3 (%)	Channel 4 (%)	Channel 5 (%)	Channel 6 (%)	Channel 7 (%)	Fault Codes	Changed Set-up Parameters
15:38	0.01	14	14	14	13	13	13	0%	0%	0%	0%	0%	0%	0%	N/A	N/A
15:38	0.06	14	13	14	12	13	12	0%	0%	0%	0%	0%	0%	0%	N/A	N/A
15:38	0.11	14	13	13	12	12	12	0%	0%	0%	0%	0%	0%	0%	N/A	N/A
15:38	0.16	14	13	13	13	12	13	0%	0%	0%	0%	0%	0%	0%	N/A	N/A
15:38	0.21	14	13	13	12	12	12	0%	0%	0%	0%	0%	0%	0%	N/A	N/A
15:38	0.26	14	13	13	13	12	12	0%	0%	0%	0%	0%	0%	0%	N/A	N/A
15:38	0.31	14	13	13	13	12	12	0%	0%	0%	0%	0%	0%	0%	N/A	N/A
15:38	0.36	14	13	14	12	12	12	0%	0%	0%	0%	0%	0%	0%	N/A	N/A
15:38	0.41	14	13	13	13	12	12	0%	0%	0%	0%	0%	0%	0%	N/A	N/A
15:38	0.46	14	13	13	12	13	12	0%	0%	0%	0%	0%	0%	0%	N/A	N/A
15:38	0.51	14	13	13	13	12	12	0%	0%	0%	0%	0%	0%	0%	N/A	N/A
15:38	0.57	14	14	13	13	12	12	0%	0%	0%	0%	0%	0%	0%	N/A	N/A
15:39	0.62	14	13	14	12	12	12	0%	0%	0%	0%	0%	0%	0%	N/A	N/A
15:39	0.67	14	13	14	13	12	13	0%	0%	0%	0%	0%	0%	0%	N/A	N/A
15:39	0.72	14	13	13	12	12	12	0%	0%	0%	0%	0%	0%	0%	N/A	N/A
15:39	0.77	14	13	13	13	12	12	0%	0%	0%	0%	0%	0%	0%	N/A	N/A
15:39	0.82	14	13	13	13	12	12	0%	0%	0%	0%	0%	0%	0%	N/A	N/A
15:39	0.87	14	14	14	12	12	12	0%	0%	0%	0%	0%	0%	0%	N/A	N/A
15:39	0.92	14	13	14	12	12	12	0%	0%	0%	0%	0%	0%	0%	N/A	N/A
15:39	0.97	14	13	13	12	12	12	0%	0%	0%	0%	0%	0%	0%	N/A	N/A
15:39	1.02	14	13	13	12	12	12	0%	0%	0%	0%	0%	0%	0%	N/A	N/A
15:39	1.07	14	14	14	12	12	13	0%	0%	0%	0%	0%	0%	0%	N/A	N/A
15:39	1.12	14	13	13	13	12	13	0%	0%	0%	0%	0%	0%	0%	N/A	N/A
15:39	1.17	14	13	13	12	12	12	0%	0%	0%	0%	0%	0%	0%	N/A	N/A
15:40	1.22	14	14	13	13	13	12	0%	0%	0%	0%	0%	0%	0%	N/A	N/A
15:40	1.27	14	13	13	13	12	12	0%	0%	0%	0%	0%	0%	0%	N/A	N/A
15:40	1.32	14	13	13	12	12	13	0%	0%	0%	0%	0%	0%	0%	N/A	N/A

The Firmware screen tab

The firmware screen tab gives information on what version of firmware the PCB's are running, just select the screen and press the refresh button and the values will appear.

Field Engineer Test

Serial Port: File [] 3.0.1.4 Last Clicked: Clear Chart

OFF [X] Comment []

Set-up Temperatures Communications Log **Firmware** Graph

Serial Number: 17615 [Refresh]

Firmware Versions

- Main Board (MCU1): 6.2 [Refresh]
- Main Board (MCU2): 2.6
- User Panel (MCU3): 1.2

The graph screen tab

The graph screen tab gives temperature information for all of the cooking zones and the user panel by using a graph, each zone has a different colour and time and temperature is recorded, individual zones can be recorded on their own if required.

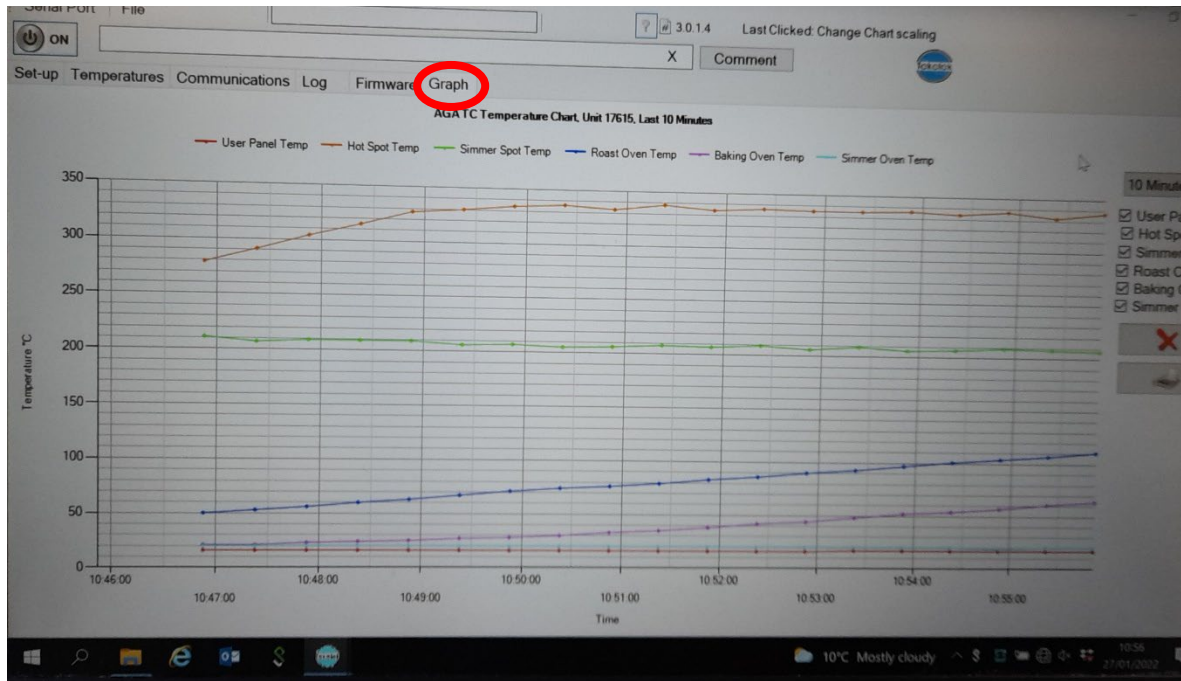

Engineer's diagnostic handset - (AE4M280323)

An engineer's handset is available, this is mainly a temperature tester but also gives reference to a selection of fault codes.

The handset gives temperatures in degrees Centigrade.



Using the engineers hand set:

A special handset is supplied to Aga Er7 engineers, as a diagnostic tool. This can be recognised by its orange coloured trim. A red handset is available for the USA this will display the temperatures in degrees Fahrenheit

It will show the serial number of the RF electronic unit to which it is connected and can then display the temperatures of each heating zone as currently seen by the cooker's software.

The screen also confirms continuing communication with the cooker by means of arrows in top right hand corner.

Battery condition is displayed in top left hand corner.

To 'handshake' and communicate to a particular cooker make sure the cooker is on standby or turned on then press the '+' button.

The cooker serial number will then be displayed and you will be asked to confirm by pressing '+' again.

Pressing buttons '1, 2, 3, 4, or 5' call up the specific zones as follows:

1. Boiling Plate
2. Simmering Plate
3. Roasting Oven
4. Baking Oven
5. Simmering Oven

Each zone has two thermocouples measuring temperatures and both values are shown. They should normally be within about 2 degrees of each other. If there is an error present the code number will also be displayed. It also displays any error codes relative to each zone and their explanations. If the E button is pressed the engineer can scroll down the error codes.

Removal and replacement of major components

When replacing components ensure that the mains power supply is isolated.

Main PCB:

Remove the magnetic plinth at the base of the cooker, Remove 2 screws either side of PCB tray. Pull the PCB tray out from the cooker.



When the PCB tray is pulled out this will give access to the main electrical cable terminal block, element connection terminal block (these are labelled and colour coded for easy identification), external vent fan connection and vent fan speed adjuster , communication cable connection and electrical supply configuration key , there is also a system information LCD display.

When a new PCB is required a complete tray is supplied the service technician disconnects all the required cables and then reconnects in the correct order, tightening the connections to the correct torque setting.

Always do a mains voltage and polarity check, the TEK PCB will not work with reverse polarity

Boiling plate and Simmer plate:

To gain access and to remove the boiling and simmer plate, remove 4 chrome buttons and stay nuts from the top plate of the cooker, lift top plate and prop front of top plate with hob support bars.



With the top plate propped the elements can be viewed from underneath, they are held in place by a fixing bar, when the bar is removed the element can be lifted out from the top plate, reassemble in reverse order.

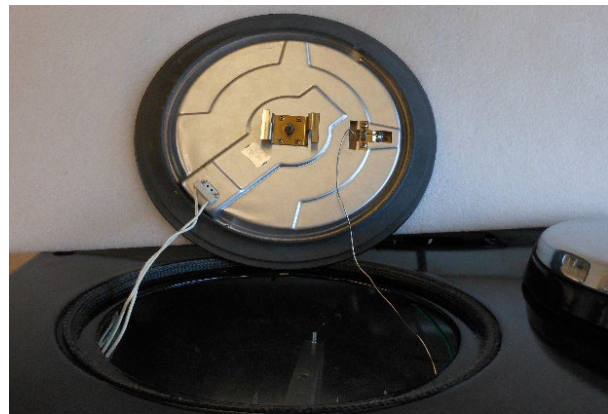
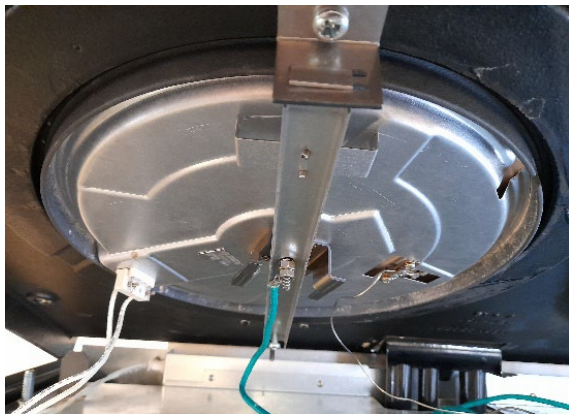

The element can be carefully propped up against the lid, ensure the lid and top plate are protected to prevent any damage occurring.

The element connections are of the plug in type and are located towards the rear of the cooker.

The thermocouple is attached to the element using the bracket shown, it is important when replacing the thermocouple to locate the tip in the right position on the element

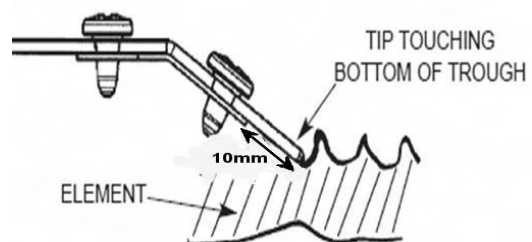
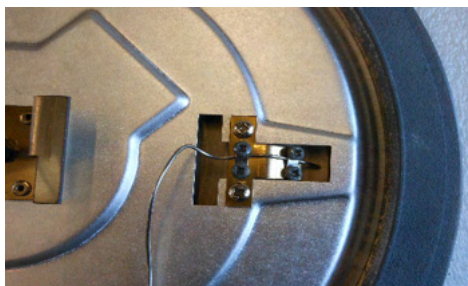

The duplex thermocouples used in the Aga eR7 are all of the same type for all cooking zones.

Customers Touch Control:

To gain access to the TCU whether to exchange or to gain access to the thermocouple connections the cooker front plate will need to be removed, to do this the top plate will need to be propped, the front plate is secured by three studs/nuts along its top length, remove the nuts and pull the top plate forward and lifted away from the cooker base plate leaving the tunnels and control panel secured to the main cooker chassis. Silicone seals are attached to the front plate which would require replacement if the front plate is exchanged.

Front Plate:

To remove the front plate, remove the cooker doors and store safely, then undo the 3 securing nuts sited along the top length of the front plate, pull the front plate forwards and lift away from the base of the cooker, replace in reverse order.

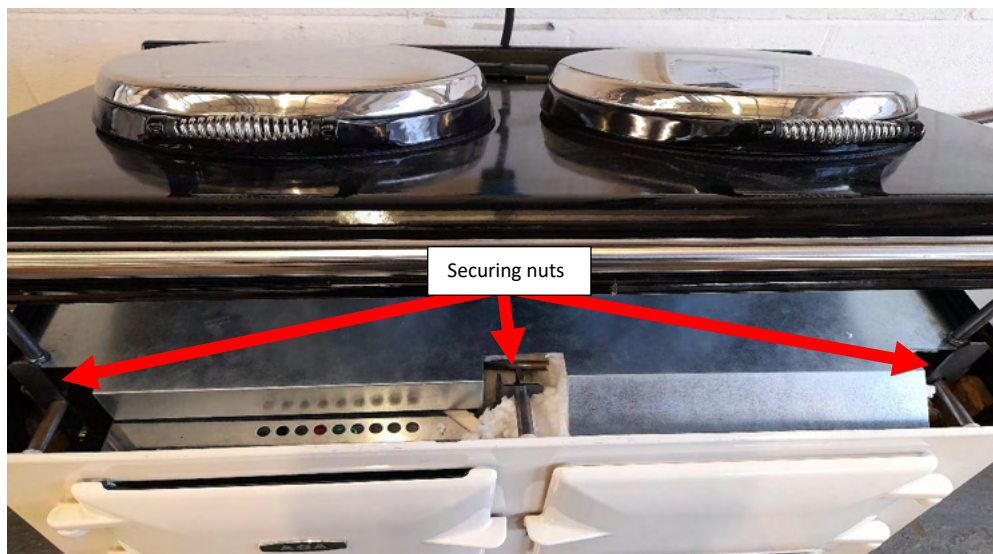

Oven doors:

Remember when refitting the oven doors to fit in the right configuration.

The Baking and Simmer oven doors have a gap in the door rope seal whereas the Roasting oven has no gap as per the diagram below.



Touch control unit and thermocouples:

The TCU is attached to the main chassis by 4 screws, remove the screws to either exchange or gain access to the rear of the panel, REMEMBER to support the TCU when doing this.

The thermocouples and the communications cable are all connected to the rear of the TCU.

The thermocouples are connected to the TCU in a certain order, it is important when either replacing the TCU or a thermocouple, that the thermocouples are replaced in their correct position.

The abbreviations of the cooking zones are imprinted on the back of the TCU

BO (Baking oven),HS (Hot Spot / Boiling plate), SS (Simmer spot), SO (Simmer oven), RO (Roast oven).

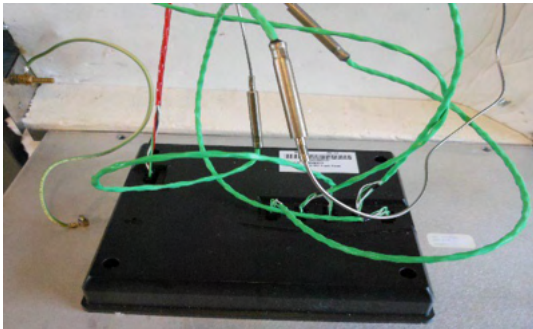

The thermocouples are routed into their zones via conduits that run through the cooker and they are held in place in a bracket in their respective zone. When a thermocouple is replaced the rubber bungs must be put back in position to seal the conduit (see picture below).

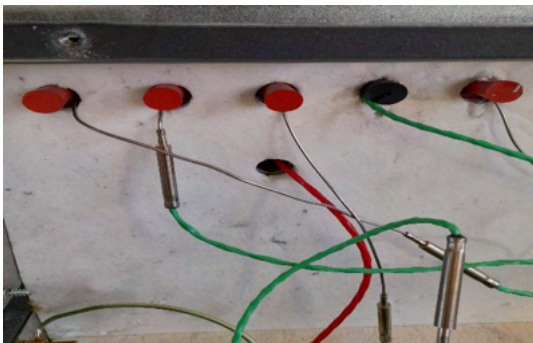

Thermocouples entering conduits.



Roast oven thermocouple in bracket

Oven elements:

The oven elements in the Aga Er7 are all rated at 2.5 kw (2500 watts) so they all have the same part number, the roasting and baking oven have two elements located in the roof and base of the oven whereas the simmer oven has one element located in the base, the simmer oven element although the same type of element only operates at 50% of its power rating this is pre-programmed within the PCB. The oven elements are held in position by 2 allen type screws, one at the front and one at the rear. The elements can be removed by removing the screws, lifting and propping the element and then disconnecting the electric connections and lifting the element out of the oven cavity, when removing the top oven elements care must be taken so they do not drop down into the oven and when replacing the top oven element, a car jack or similar can be used to hold the element in position whilst locating the threads for the screws.

When exchanging or inspecting an oven element if the cable is damaged a new cable will need to be fitted, the cables are routed from the element, and then drop down in the back of the cooker and run to the main PCB.

The resistance of the elements will be approx. 18 – 22 ohms.

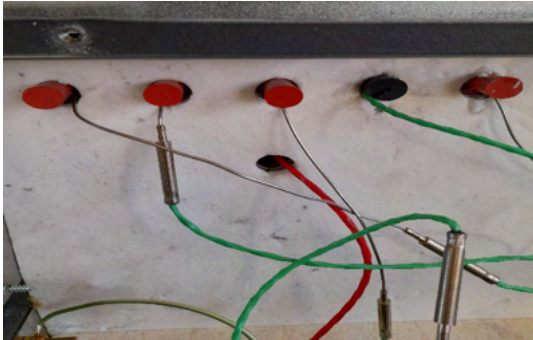

Baking oven base element

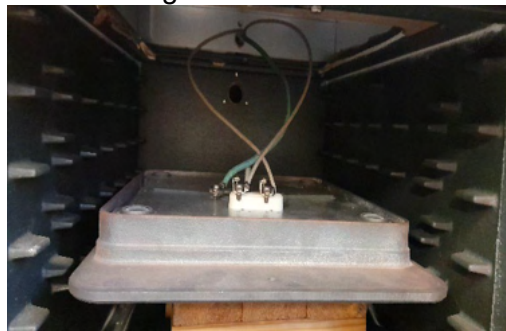

Baking oven top element

AGA Hotcupboard eR7 150

This is fundamentally an Aga eR7 with the addition of a hot-cupboard unit, being a single cavity divided as normal into two zones by a cast-iron shelf. These are designated slow cooking oven (to avoid confusion with the simmering oven in the parent Aga Er7) and a warming oven.

It is supplied fully assembled and electrically tested.

Unlike the situation with a heat store Aga, the hot-cupboard does not need to be warm at all times. The owner chooses when they want the unit heated, simply by operating a push-button switch.

An adjacent neon light indicates when power is switched on. From cold, it takes approximately 40 minutes to achieve a stabilised temperature. Some heat is delivered into the warming plate by convection.

Customers can also opt to have a single zone induction unit top.

The hot-cupboard does not take its heat or energy from the parent Aga. Instead, it has its own integral electric heating elements located at the rear. One element rated at 400W is a boost to help raise the temperature from cold, after which the pre-set thermostat operates, leaving the second element (rated 200W) in circuit to maintain temperature. Both are also controlled by a pre-set limit/overheat thermostat.

The element is sited in the back of the unit and can be accessed by removing the cast iron dividing shelf and removing the rear grid by lifting upwards, the element is held in position by 2 screws, remove the screws and pull the element to the right, this will expose the electrical connections.

The thermostat, overheat thermostat and switch assembly can be accessed by removing the four chrome buttons and stay nuts and propping the top plate, always taking care to avoid enamel damage.

Essential Parts List

- | | |
|---------------------------------|------------|
| • Tekelek PCB | AE4M280812 |
| • Touch control unit | AE4M281316 |
| • Boiling /Simmer plate element | AE4M281314 |
| • Top plate element rope seal | AE4M233717 |
| • Oven element | AE4M280036 |
| • Thermocouple | AE4M280732 |
| • Customers Handset | AE4M280526 |

Wiring schematic. (North America)

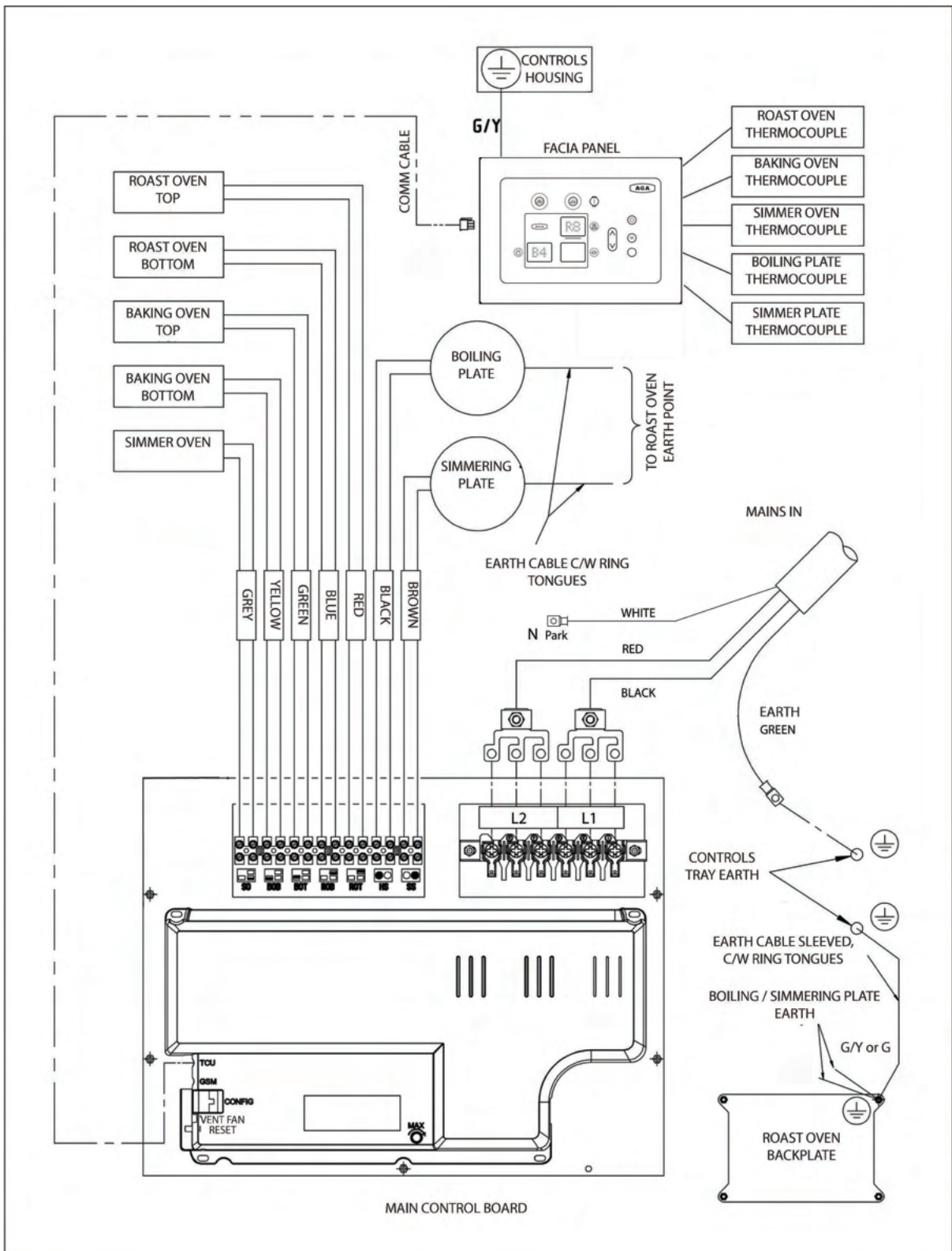

Aga Cookers --- oven door adjustment

For the past 15 years or more, the Aga cooker has incorporated eccentric door hinge pins.

As part of the manufacturing process doors are set and adjusted to their individual front plates at works.

However, checking the fit of the oven doors is still an essential part of the final cooker site installation as there may have been some adverse movement during transit.

It is also important that the door fit integrity is checked as part of a routine service, adjustment being required as the rope seals bed in and due to natural wear.

In both cases adjustments are made as follows

Ensure that each door is in its correct location, i.e. Roasting & Simmering ovens.

Ensure that the nylon washers are in place on each lug.

Ensure that the hinge pin is fully inserted into the door lug casting. (If it is not, then the grub screw may not locate into its recess) Check that the grub screw has been fully tightened, using a 3mm hex key

A quick test of the door fit can be made by gently tapping each corner and sensing for any undue movement.



Aga Cookers --- oven door adjustment

To confirm that the seal is effective, check the grip of the door seal at several points using a folded piece of paper, which should just be 'held' by the seal, but still able to be pulled out



If necessary adjustments are made as follows. Having first loosened the grub screws, close the door onto its catch. Slightly turn the eccentric hinge pins with a flat blade screwdriver.. This will have the effect of moving the hinge side of the door closer or further away from the front. Generally it will be necessary to adjust both top and bottom pins by equal amounts unless trying to correct a specific corner or edge. Repeat the paper test and remember to retighten the grub screws.

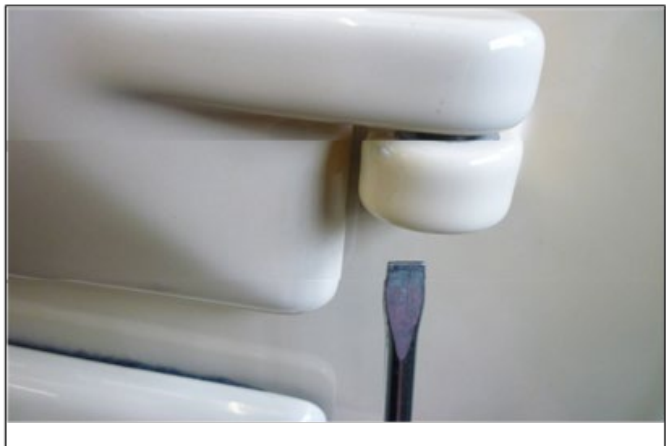

With the door closed, make sure that it latches down sufficiently onto its catch. If too tight it might be necessary to adjust the eccentric pins one more to prevent the door becoming 'hinge bound' when the cooker is up to temperature



Technical Bulletin

AGA RANGEmaster

Document: EC 03/07/19 v1.5



AGA MARVEL



LA CORNUE

MERCURY
DESIGNED FOR COOKING



RAYBURN

REDFYRE



Product Group	Models	Originator
AGA	All AGA Models	Technical Team

Published to: Distributors / AGA Service Engineers

Subject: AGA Door Pins

As part of our commitment to continuous improvement, we are working closely with our supply partners to improve all components.

The reason for implementing a newly designed pin is to provide a larger surface area for the grub screw to fix onto, thus keeping the pin fixed in place with less chance of loosening.



New pin – flat edges where the M6 x 10mm grub screw holds the pin in place

Old pin – rounded edge where the M6 x 10mm grub screw holds the pin in place

When installing a new appliance, can we request that you proactively change the doors pins for the improved version should they be required. In addition, any customers who experience door adjustment issues should also have the improved pins fitted.

If the engineer decides a new pin is required then both pins must be replaced on the door.

When adjusting the new style pin, there are now only four positions of adjustment. You must ensure the pin is positioned so the grub screw is tightening onto a flat edge of the pin.

When leaving the factory a loc-tite patch is inserted into the grub screw thread which can be used multiple times for adjustment.

If you need to order the new style pins the part number to use is **AE4M212654** and can be ordered on your warranty account. The old part number AO4M211885 is no longer available.

Important – Do not mix and match pin styles on a single door

If required, further guidance can be sought from the AGA Rangemaster Technical Department on 01952 643 142 (opt 2) or by email technicalsupport@agarangemaster.co.uk

AGA INSULATING LID HINGE ASSEMBLY (Introduced 2005)

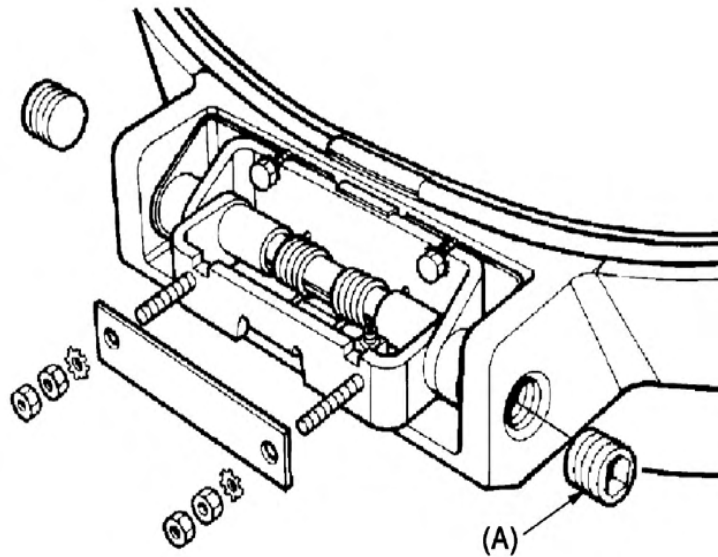

The insulation lids are supplied complete with the hinge fitted. The hinge end bearing locking grub screws (A) 2 off are supplied loose.

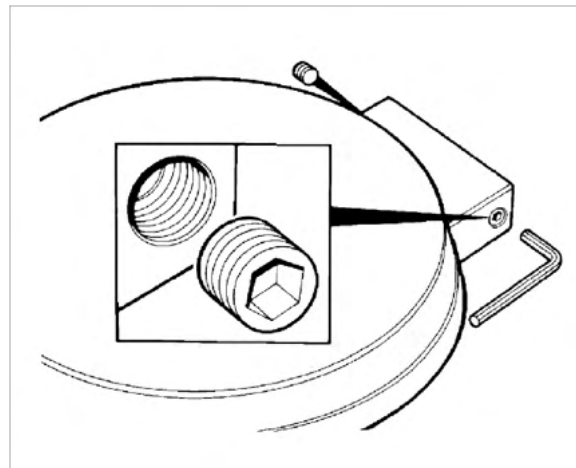
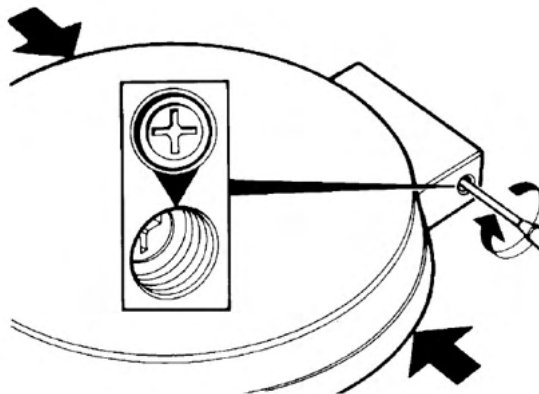

Ensure the lid is sitting evenly in the closed position. Adjust the level of the lid if required, by turning the adjustable bearing (located inside the ends of the hinge) with a pozi drive screwdriver, through the tapped holes in the cast iron lid.

When the desired level of the lids is achieved, lock the bearing with the flat face locking grub screw using an allen key.

Open and close the lids a few times to check the adjustable bearings are positively locked in and the lids are sitting evenly

With AGA Rangemaster's policy of continuous product improvement, the Company reserves the right to change specifications and make modifications to the appliances described and illustrated at any time.