

**ZOELLER**<sup>®</sup>  
PUMP COMPANY



## Pumps and Systems

Utility, Pedestal

Backup Systems

Sump, Effluent, Dewatering

Sewage Pumps

Grinder Pumps and Systems

Specialty Products



Trusted. Tested. Tough.<sup>®</sup>



## WHAT SETS ZOELLER PUMPS APART?

Since 1939, Zoeller Company has been manufacturing water pumps of many types. From pedestal pumps in the beginning to large HP, submersible, non-clog pumps in recent years, we have gained invaluable manufacturing experience from our humble beginning in August Zoeller's basement workshop.

Over the years, one of our most important mottos has been, 'We excel at 1,000 little things'. From start to finish, we take pride in our products. When you have residential or commercial wastewater issues, you can count on Zoeller to deliver the very best solutions. Our commitment to unsurpassed quality offers years of service and durability with a responsive and knowledgeable product support team just a phone call away.

- **MANUFACTURING IS IN OUR BLOOD...**

Rather than using a 'puzzle piece' mentality and simply buying components from other sources and assembling them, we manufacture most of our products from start to finish, continually checking the quality throughout the entire process.

Quality is always the most important element at Zoeller. Above all, quality is what has made us successful and continues to drive the decisions we make. A quality product cannot be manufactured with low-grade components. By bringing in high-quality raw castings as well as machining and powder coating the pieces in house, we are able to control the quality of each part and identify any defect throughout the manufacturing process. Each piece is subjected to numerous quality checkpoints along the way to guarantee that it is the best of the best.

- **FACTORY TESTING IS NOT JUST A BUZZWORD...**

Instead of running 'audits' on a calculated number of pumps, all submersible Zoeller pumps are 100% factory tested underwater prior to shipment. Each pump is subjected to a leak test to ensure that all gaskets, seals and mating surfaces will hold under pressure. After the pressurized leak test, the pump is powered up and run underwater to ensure that it is capable of the published head capacity and flow rate listed in our catalog and specification sheets. This testing allows us to guarantee the pump will operate out of the box every time, and you can rest assured that YOUR Zoeller pump was tested underwater for both electrical and hydraulic performance.

- **FULL BREADTH OF PRODUCT LINE...**

Zoeller is your 'one stop shop' when dealing with dewatering and wastewater systems. We offer everything from a small fractional sump pump to a large, 60 HP, non-clog pump. From battery back-ups, check valves, sewage grinder systems, small prepackaged residential units or large prepackaged municipal systems, Zoeller can offer it all. Next time you are looking for a water or wastewater system, reach for the only catalog you will ever need... Zoeller Company!

**ZOELLER PROVIDES  
THE BEST PRODUCTS  
AT EVERY PRICE POINT.**

# Professionals Training Professionals



The Center For Excellence training facility at Zoeller Company in Louisville, Kentucky offers a unique opportunity to experience the pump industry, learning from experts in the field. Bring your customers for an hour, a day, or more. Learn about the pump industry and why Zoeller products are designed to be the best for professionals.

## What We Do

Gain first-hand experience in the unique and varied aspects of pump manufacturing and specification at our 6,000 ft<sup>2</sup> training facility. In the demonstration room, our industry professionals offer live demonstrations and computer simulations of our latest products and core concepts. Lift stations including active controls are designed to demonstrate the how-and-why of pump technology. A state-of-the-art classroom provides space for lectures and group discussions with a library of cutaway models for reference.

## Training Tailored To Meet Your Needs

Training experiences at the CFE are tailored to cover the specific topics that most interest you and your customers. All participants gain valuable technical and practical product knowledge. Our training staff will work with you to design the most profitable experience for your group.

Some topics we have covered to date include:

- Pump sizing
- Troubleshooting a control panel
- Product overview
- Startup training
- How performance curves are created
- Rail systems



Email us! [cfetraining@zoeller.com](mailto:cfetraining@zoeller.com)



# 42, 44, 46

## Floor Sucker Series

Ideal for intermittent use, these pumps can draw water down as low as 1/8" (3 mm). To reduce maintenance and eliminate clogging, a screened bottom intake design is used. Motor life is enhanced and extended by an energy-efficient design and a UV-protected pump body. Pump discharge is fully adaptable to standard garden hose connections, and a handle is provided for ease of handling.

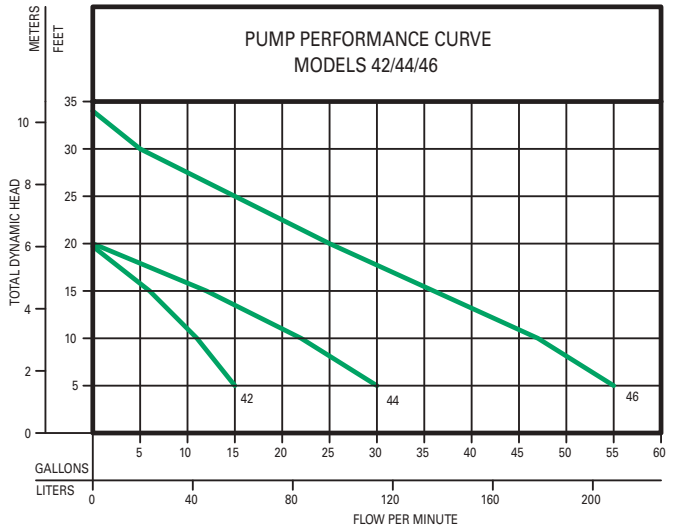

**APPLICATIONS:**

- General water transfer
- Dewatering

**SPECIFICATIONS:**

- 3/4" (19 mm) garden hose outlet
- Thermally protected motor
- LM44 is AUTOMATIC with no float switch

- Available with 9' or 20' (3 or 6 m) power cord
- Oil free (models 42, 44)
- Temperature rated 104 °F (40 °C)

014066

For more information, see Technical Data Sheet FM2773.

# 311

## Mighty Mover

Ideal for intermittent use, this portable and lightweight transfer pump performs at a high level. This type of pump often experiences dry-run conditions, so the metal pump housing and nylon impeller (extra impeller included) can outperform similar products with plastic pump housings. It includes a suction hose and remote suction plate for added convenience.

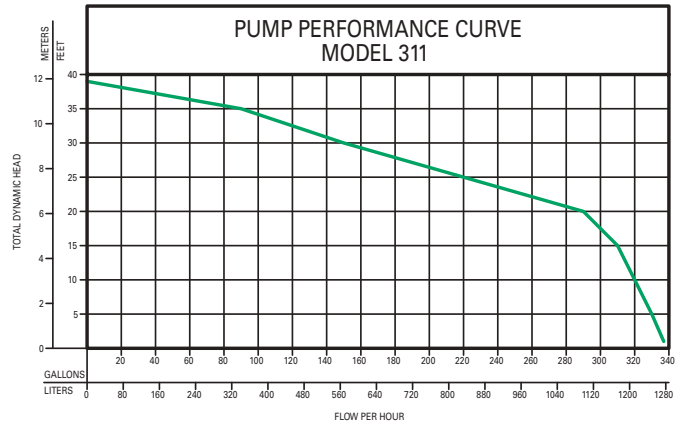

**APPLICATIONS:**

- General water transfer
- Draining water heaters
- Filling radiant heating lines

**SPECIFICATIONS:**

- 3/4" (19 mm) garden hose inlet and outlet
- Includes 6' (2 m) suction hose and remote suction plate
- Available with 6' (2 m) power cord
- Temperature rated 130 °F (54 °C)

For more information, see Technical Data Sheet FM2774.

SK2176

# 314

## Water Mover

Generating almost 50 PSI, this is our most powerful transfer pump. The durable cast iron pump housing and easily serviced brush motor ensure trouble-free operation. For convenience, an oversized priming handle is included, so no tools are required. The extra-long power cord and pump-mounted on-off switch simplify operation.



### APPLICATIONS:

- Water transfer
- Power washing
- Filling radiant heating lines

### SPECIFICATIONS:

- 3/4" NPT inlet and outlet with lead-free brass garden hose adapters
- Includes suction screen and extra set of brushes
- Available with 20' (6 m) power cord
- Temperature rated 120 °F (49 °C)

For more information, see Technical Data Sheet FM2775.

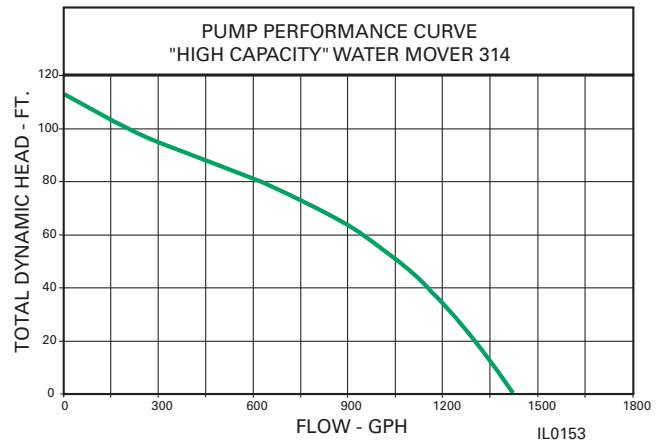

UTILITY, PEDESTAL

# 81, 82, 84

## Old Faithful

Ideal for residential sump pits, these column pumps feature an above-pit cover motor design. An adjustable float allows the user to set the on and off points that best meet their needs. The permanently lubricated motor is thermally protected for quiet operation and longer life. The non-clogging vortex impeller and inlet screen help eliminate jamming from debris such as leaves and other small particles.



### APPLICATIONS:

- New sump and residential construction
- Sump pits

### SPECIFICATIONS:

- 1-1/2" or 1-1/4" NPT discharge
- Top inlet eliminates air-locked conditions
- Adjustable float
- 81/82 thermoplastic base, 84 cast iron base
- Temperature rated 130 °F (54 °C)

For more information, see Technical Data Sheet FM2776.

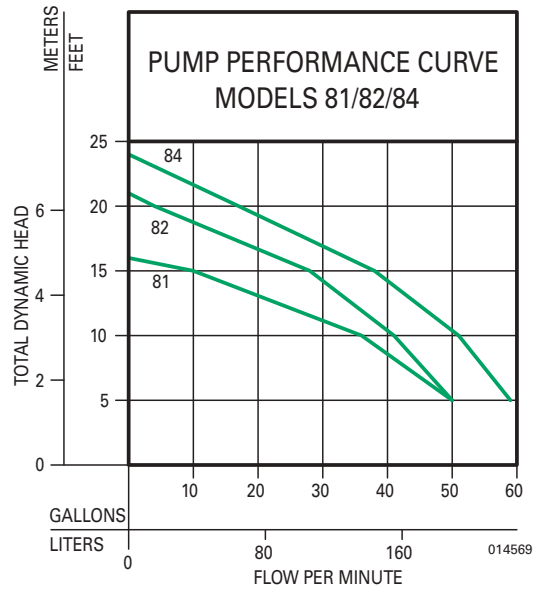

49

# Water Ridd'r III

This compact, robust pump fits into smaller sump basins. The factory-set float switch is set to maximize pump range while ensuring no float hang-ups. The sturdy pump base keeps larger debris from clogging the pump and prevents the pump from moving around the pit.

**APPLICATIONS:**

- Residential sump
- New construction sump

**SPECIFICATIONS:**

- 1-1/2" NPT discharge
- Mechanical float
- Available with 10' (3 m) power cord
- 3/8" (9 mm) solids passing

For more information, see Technical Data Sheet FM2777.



SUMP, EFFLUENT

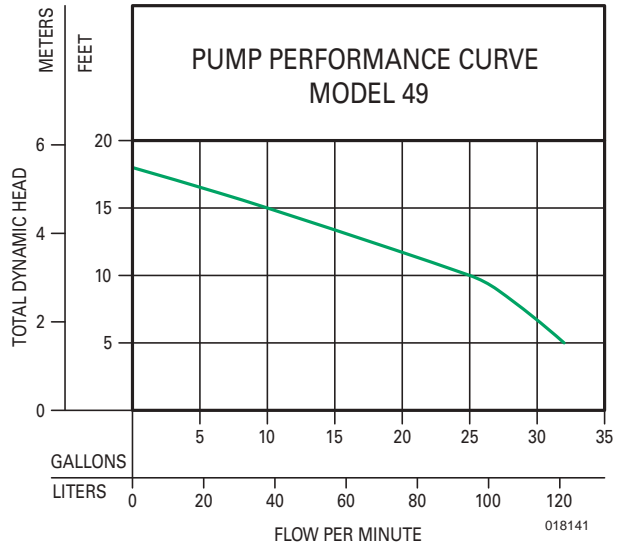

73, 75

The Models 73 and 75 offer accessible quality for the cost conscious. These submersible pumps are designed for use in residential or light commercial dewatering applications and can be used to transfer groundwater or effluent. The pump includes a cast iron motor housing with a corrosion-resistant, baked-on enamel finish and is designed to provide great heat dissipation from the motor, ensuring a long service life.

**APPLICATIONS:**

- Water transfer
- Sump and dewatering systems
- New sump and residential construction

**SPECIFICATIONS:**

- 1/3 HP (Model 73) and 1/2 HP (Model 75)
- 1-1/2" NPT discharge
- Thermally protected motor
- Available with 10' (3 m) power cord
- 3/8" (9 mm) solids passing

For more information, see Technical Data Sheets FM2897 and FM2849.

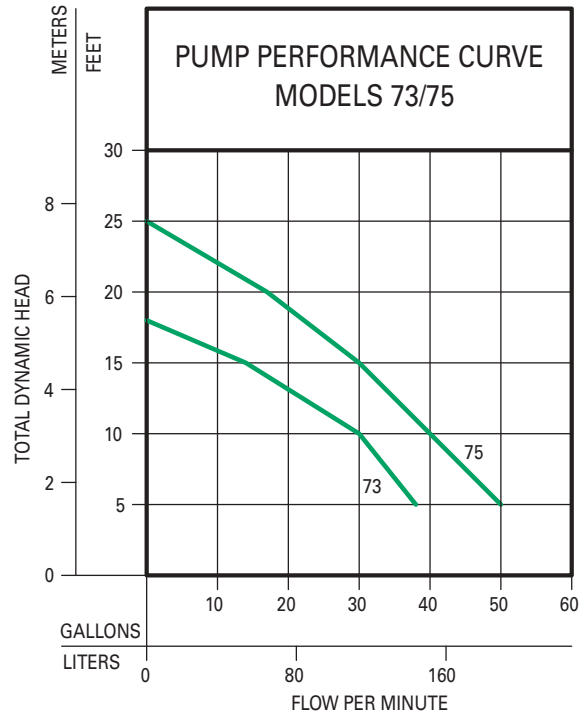

153894

# 53<sup>®</sup>, 55, 57, 59, 98

## Mighty-Mate/Flow-Mate

Considered one of America's most popular sump pumps. This robust family of sump pumps is known for reliability, durability and performance. Available with an intergral, 2-pole, snap-action float switch. The heat-dissipating cast iron body with powder coated epoxy finish provides maximum pumping performance under the most extreme conditions. With Zoeller's cool run design, the hermetically sealed, oil-filled motor and non-clogging vortex impeller add up to a long-lasting, trouble-free product. Models 53-0001 and 98-0001 come with the Zoeller LED Plug that allows you to check for power at a quick glance.



### APPLICATIONS:

- Water transfer
- Sump and effluent systems
- Light commercial
- New sump and residential construction

### SPECIFICATIONS:

- 1-1/2" NPT discharge
- 3/10 HP (53<sup>®</sup>, 55, 57, 59), 1/2 HP (98)
- Zoeller LED Plug on 53-0001 and 98-0001
- Available in automatic or nonautomatic
- 1/2" (12 mm) spherical solids capacity
- Thermoplastic or cast iron base
- Thermoplastic or cast iron impeller
- Bronze construction available (55/59 series)

For more information, see Technical Data Sheets FM2778, FM2779.



Nonautomatic model with piggyback

Automatic model 98-0001



Automatic model 53-0001

### OPTIONAL\* PUMP STAND P/N 10-2421

- Reduces potential clogging by debris
- Replaces rocks or bricks under the pump
- Made of durable, non-corrosive ABS
- Raises pump 2" (5 cm) off bottom of basin
- Provides the ability to raise intake by adding sections of 1-1/2" or 2" (DN40 or DN50) PVC piping
- Attaches securely to pump
- Accommodates sump, dewatering and effluent applications

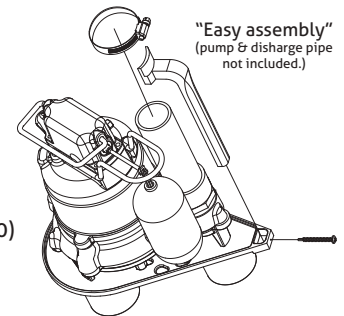

"Easy assembly" (pump & discharge pipe not included.)

NOTE: Make sure float is free from obstruction.

\*Fits series 49, 50, 63, 70, 95, 98, 130, 140 and 150.

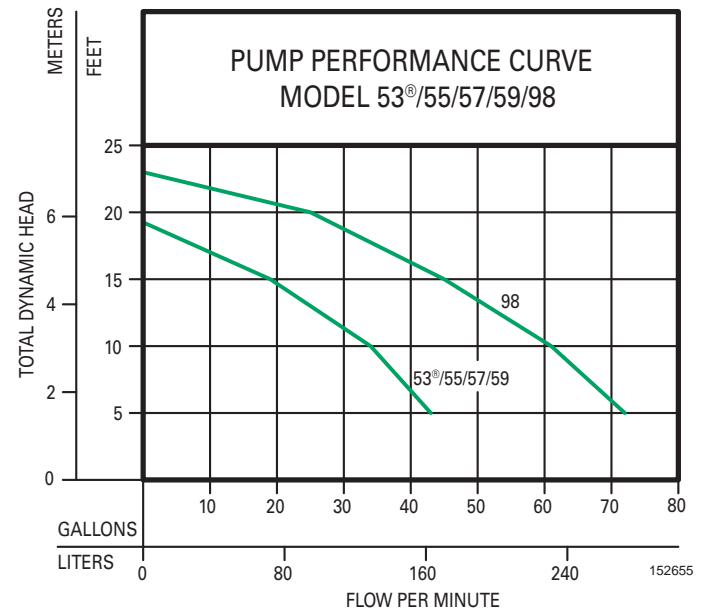

# 63

## Premium Series

These Premium sump pumps are designed with the very best materials and latest technology. Based on the 50 series sump pump, considered one of America's most popular sump pumps, this product offers advanced switch technology allowing for longer switch life.



This model is constructed of the same heat-dissipating cast iron with powder coated epoxy finish, providing maximum pumping performance under the most extreme conditions. With Zoeller's cool run design, the hermetically-sealed, oil-filled motor and non-clogging vortex impeller add up to a long-lasting, trouble-free product. The heavy-duty power cord also includes the Zoeller LED Plug that allows you to check for power at a quick glance.

### APPLICATIONS:

- Water transfer
- Sump systems
- Light commercial
- New sump and residential construction



### SPECIFICATIONS:

- 1-1/2" NPT discharge
- 3/10 HP
- 1/2" (12 mm) spherical solids capacity
- Zoeller LED plug
- Available in automatic operation only
- Advanced switch technology
- Viton switch arm boot and heavy-duty power cord
- Cast iron, non-clogging vortex impeller
- Cast iron base

For more information, see Technical Data Sheet FM2899.

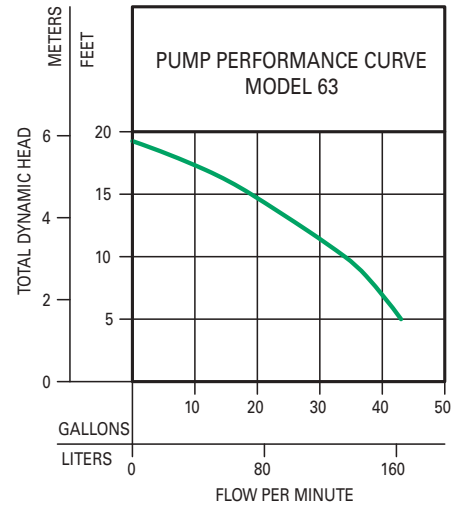

# 95

## Premium Series

The Model 95 Premium sump pump is designed with the very best materials and the latest technology. Based on the 98 sump pump, one of America's most popular sump pumps, this product offers advanced switch technology ensuring longer switch life. The Premium sump pump also provides 10% higher performance (GPM and TDH) over the Model 98.



This model is constructed of the same heat-dissipating cast iron with powder coated epoxy finish, providing maximum pumping performance under the most extreme conditions. With Zoeller's cool run design, the hermetically-sealed, oil-filled motor and non-clogging vortex impeller add up to a long-lasting, trouble-free product. The heavy-duty power cord also includes the Zoeller LED Plug that allows you to check for power at a quick glance.

### APPLICATIONS:

- Water transfer
- Sump systems
- Light commercial
- New sump and residential construction

### SPECIFICATIONS:

- 1-1/2" NPT discharge
- 1/2 HP
- 1/2" (12 mm) spherical solids capacity
- Zoeller LED plug
- Available in automatic operation only
- Advanced switch technology
- Viton switch arm boot and heavy-duty power cord
- Non-clogging vortex impeller
- Cast iron base

For more information, see Technical Data Sheet FM2985.

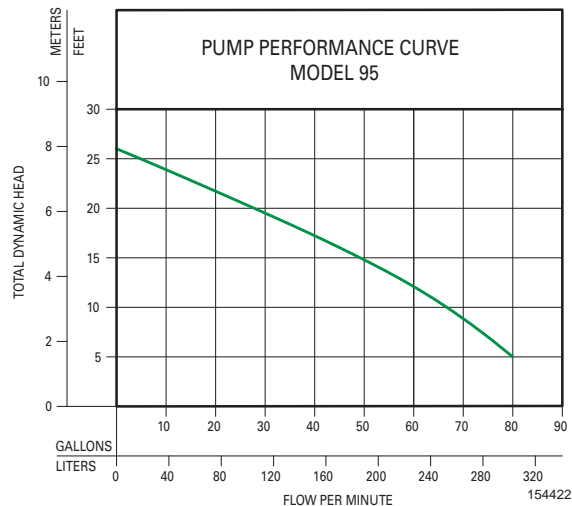

# 137, 139, 140, 145

## Flow-Mate

In high head dewatering or effluent applications where pumping performance is critical, this robust family of pumps is known for reliability, durability and performance. These pumps are especially suited for harsh environments. Zoeller's cool run design and corrosion-resistant, powder coated epoxy finish add up to a long-lasting, trouble-free product.

### APPLICATIONS:

- STEP or onsite applications
- Water transfer
- Light commercial dewatering

### SPECIFICATIONS:

- 1-1/2" NPT discharge
- 1/2 HP through 1 HP
- Available in automatic or nonautomatic
- Model 137, 139, 140: 1/2" (12 mm) spherical solids capacity with vortex impeller
- Model 145: 3/4" (19 mm) spherical solids capacity with vortex impeller



- Bronze construction available (139 series)
  - High head version available (145 series)
  - Double shaft seal versions available for added protection on models 140/145.
- For more information, see Technical Data Sheets FM2782, FM2783.

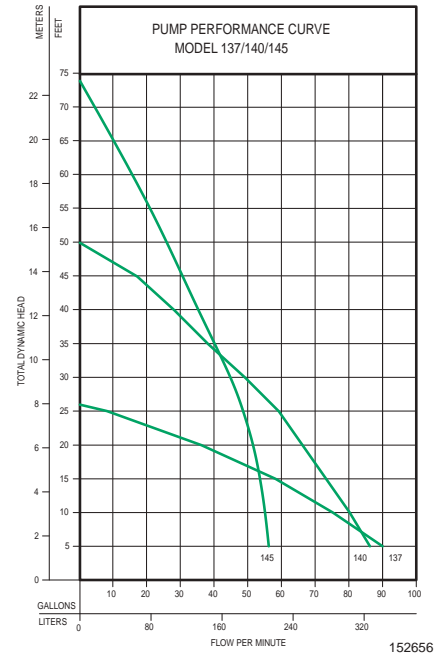

SUMP, EFFLUENT

# 151, 152, 153

## Dose-Mate

This is our fastest growing line of effluent pumps. The 150 series is truly a workhorse designed for reliability under extreme conditions in an effluent environment. 150 series pump curves cover a wide range of applications. They are well suited to applications with low pressure pipe (LPP) and enhanced flow STEP systems. Zoeller's cool run design and corrosion-resistant, powder coated epoxy finish, in addition to the hermetically sealed, oil-filled motor and non-clogging vortex impeller add up to a long-lasting, trouble-free product.



### APPLICATIONS:

- STEP or onsite applications
- Light commercial dewatering

### SPECIFICATIONS:

- 1-1/2" NPT discharge
- 3/10 HP through 1/2 HP
- Available in nonautomatic or with a variable level piggyback mechanical switch
- 1/2" (12 mm) spherical solids capacity with vortex thermoplastic impeller

For more information, see Technical Data Sheet FM2784.

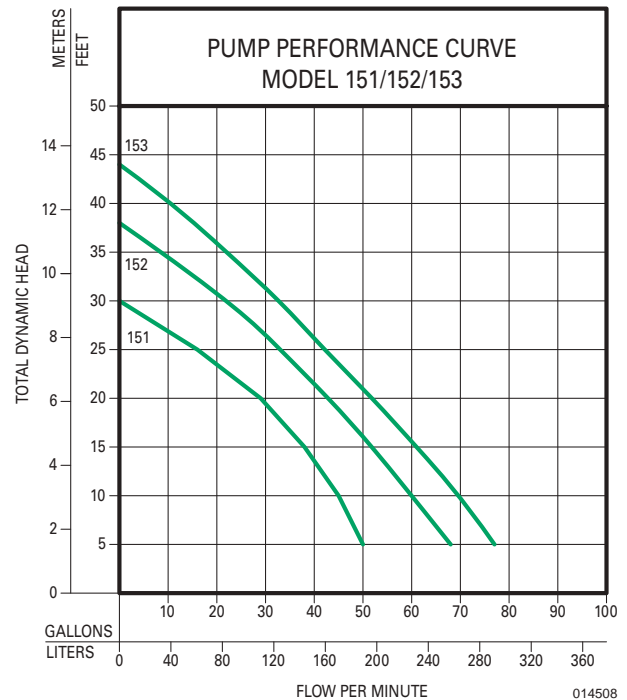

# 161, 163, 165

## Flow-Mate

Heavy duty construction with oversized bearings and a balanced bronze, non-clogging vortex impeller allow these pumps to stand up to the highest heads and maximum flows. They are well suited to applications with low pressure pipe (LPP) and enhanced flow STEP systems. Using Zoeller's cool run design, we added fins to these pumps, lowering operating temperatures. The corrosion-resistant, powder coated epoxy finish and hermetically sealed, oil-filled motor add up to a long-lasting, trouble-free product.

### APPLICATIONS:

- Onsite or septic applications
- Enhanced flow STEP systems
- Commercial dewatering
- Sump/dewatering

### SPECIFICATIONS:

- 1-1/2" NPT discharge (available with 2" or 3" NPT bolt-on flange)
- 1/2 HP through 1 HP
- Available in automatic or nonautomatic
- 3/4" (19 mm) spherical solids capacity with cast iron vortex impeller
- Double shaft seal versions available for added protection
- Thermally protected motor

For more information, see Technical Data Sheet FM2785.

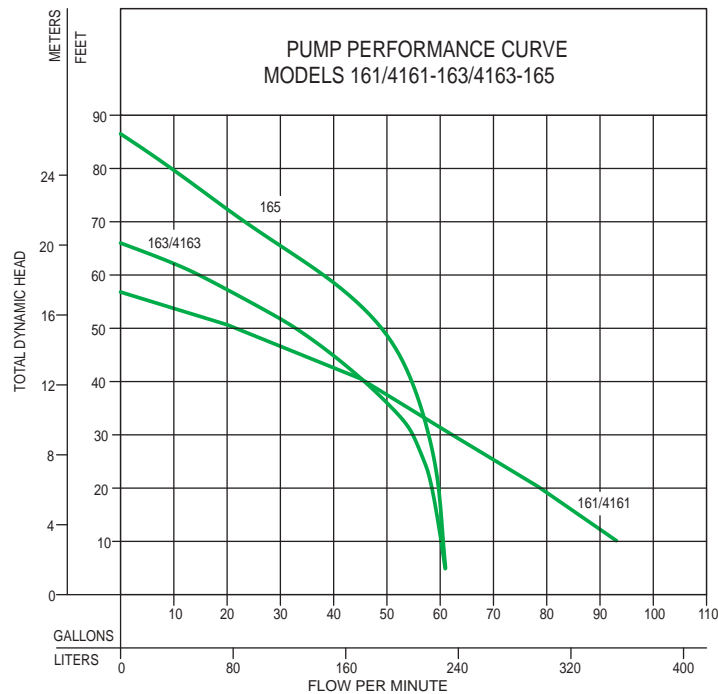

009920A

For complete product  
information, visit:  
[zoellerpumps.com](http://zoellerpumps.com)

# 185, 186, 188, 189, 191

## Flow-Mate

Heavy duty construction with oversized bearings and a balanced bronze, non-clogging vortex impeller allow this series of pumps to stand up to the highest heads and maximum flows. They are well suited to applications with low pressure pipe (LPP) and enhanced flow STEP systems. Using Zoeller's cool run design, we added fins to these pumps, lowering operating temperatures. The corrosion-resistant, powder coated epoxy finish and hermetically sealed, oil-filled motor add up to a long-lasting, trouble-free product.

### APPLICATIONS:

- High head onsite or septic applications
- Enhanced flow STEP systems
- Commercial dewatering

### SPECIFICATIONS:

- 1-1/2" NPT discharge (available with 2" or 3" NPT bolt-on flange)
- 1 HP through 2 HP
- Available in automatic or nonautomatic
- Model 180 Series: 3/4" (19 mm) spherical solids capacity with cast iron vortex impeller
- Model 191: 5/8" (16 mm) spherical solids capacity with bronze vortex impeller
- Double shaft seal versions available for added protection
- Thermally protected motor

For more information, see Technical Data Sheet FM2786.



SUMP, EFFLUENT

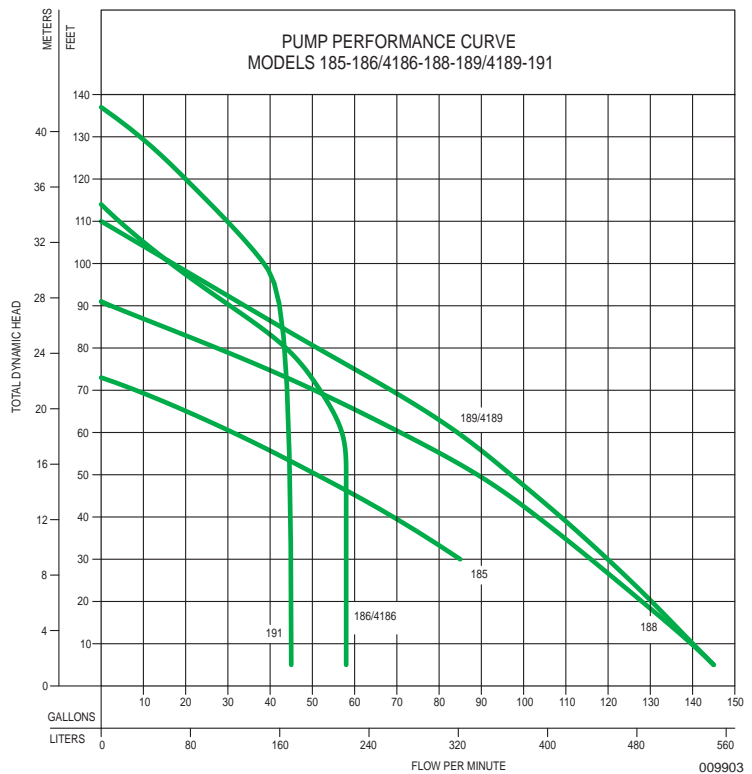

# Zoeller Backup Systems

## Self-testing Backup Systems

### Z Control Enabled Systems

The Aquanot® Fit self-testing sump pump systems take over when the main power is interrupted or the primary pump isn't getting the job done. The powerful, self-testing smart-controllers overcome problems caused by dormancy and system neglect. Fit is internet-connected through Zoeller's Z Control® Platform, granting users free 24/7 monitoring and remote control of equipment with the Z Control® mobile app or web interface. You can also receive free emails, texts, and push notifications about system status and alerts.

U.S. Patent No. D740329

### Aquanot® Fit 508

The best protection money can buy!

- Highest performance and efficiency pump
- Two independent switches, supervised by controller
- Local alarms and indicators
- Self-testing controller with built-in battery maintenance and alarms
- Z Control® free access
  - Wifi and ethernet connections
  - Remote monitoring and control
  - Email, text and push notifications
  - Additional system data, status, and tools

#### SPECIFICATIONS:

- 1-1/2" NPT discharge
- Integrated check valves
- Fit includes 508 DC pump Fit controller with built-in WiFi, vertical operational switch, high-water reed sensor switch, battery box, fittings

For more information, see Technical Data Sheet FM3124.



Free Z Control® account at





Search: "Z Control"

#### PERFORMANCE

The DC pump performance at 12.7 Vdc

Discharge Feet of Head	5 (1.5 m)	10 (3 m)	15 (4.6 m)	28 (85 m)
Flow GPM (LPM) 12.7 volts	43 (163)	35 (132)	27 (102)	Shut-off Head



# Zoeller Backup Systems

## AquaNot® Spin 508

### Self-testing 12 Volt Battery Backup Sump Pump

The high performance AquaNot® Spin 508 provides extra protection when a primary AC pump shuts down due to a power outage or another electrical problem. A smart, UL recognized charger/controller with battery burnout and overcharge protection maximizes battery life and provides over 7 hours of continuous pumping. All necessary pipes, valves, and fittings are included to transform your existing system into a complete AC/DC sump pump system. The alarm, light indicators, and self-testing ensure peace of mind for the homeowner.

#### SPECIFICATIONS:

- Self-testing pump
- Early warning and smart diagnostics
- Supervised switch connections
- Optional high water sensor
- 1-1/2" NPT discharge includes check valves
- Includes all necessary fittings for installation

For more information, see Technical Data Sheet FM3165.



## AquaNot® Key 507

### Self-testing 12 Volt Battery Backup Sump Pump

Entry level backup sump pump. When basic performance and protection is all that is needed, this solid quality pump, charger, and switch will provide peace of mind.

#### SPECIFICATIONS:

- Solid performance pump
- Fully automatic pump and charger
- Heavy duty, fully automatic, supervised switch
- Self-testing controller
- 3 year limited warranty

For more information, see Technical Data Sheet FM2804.



# Zoeller Preassembled Backup Systems



## Preassembled 12 Volt Battery Backup & Primary Sump Pump Packages

Save time and money with our top selling primary and backup sump pump packages. These systems are factory assembled with 1-1/2" schedule 40 PVC pipe and fittings for simple "drop-in" installation. Packages come with switches, automatic, agency approved charger/controllers, and an efficient pump providing up to 7 hours of continuous pumping on battery-only power. Battery burn-out, overcharge protection, and diagnostics are also included for added peace of mind.

Preassembled primary and backup sump pump packages are available for both high performance Aquanot® Series (Model 508) and entry level Basement Sentry® Series (Model 507). Several models are Z Control enabled with built in Wi-Fi.

ProPak models include choices of primary pumps: 73, 53, 63, and 98. Zoeller LED Plug comes standard on all primary pumps available with the Spin and Fit ProPak Systems. See FM2803

### SPECIFICATIONS:

- 1-1/2" NPT discharge with inline check valve
- Completely preassembled – ready to install
- Includes "America's favorite sump pump"

For more information, see *Technical Data Sheet FM2803*.

\* Primary electric sump pump only included with ProPak models.  
U.S. Patent No. D740329



ProPak | AquaNot Fit 508



ProPak AquaNot Spin 508



ProPak AquaNot Key 507



Free Z Control® account at

Z Control Cloud







Search: "Z Control"



For complete product information, visit: [zoellerpumps.com](http://zoellerpumps.com)

# Zoeller Preassembled Backup Systems

<b>MODEL COMPARISON ZOELLER BATTERY BACKUP SYSTEMS</b>				
<small>(Table FM3219)</small>		 AquaNot 508 Fit	 AquaNot 508 Spin	 AquaNot 507 Key
PERFORMANCE GPM @ 10' 12.6 V		34	34	15
RUN TIME with 12 V battery	- continuous	6 hours	6 hours	7 hours
	- 10% duty cycle	48 hours+	48 hours+	48 hours+
Total estimated gallons per battery		11,900	11,900	9,500
Self-testing		Yes	Yes	Yes
 <b>Z Control</b>		Yes	No	No
Text/Email/App notification		Yes	No	No
Secondary float		Yes	Optional 10-4830	No
Float monitoring		Yes	Yes	Yes
Battery replacement reminder		Yes	No	No
List of alarms/status		4 local/audible 10 more online	4 local/audible	4 local/audible
Warranty		3 years 5 years w/ M63 Propak	3 years	3 years
Item #		508-0014	508-0005	507-0005
ProPak combo systems primary pump included		with M53®, .3 HP 508-0015 with M98, .5 HP 508-0016 with M63, .3 HP 508-0020	with M53®, .3 HP 508-0006 with M98, .5 HP 508-0007	with M73, .3 HP 507-0013
Batteries All Aquanot batteries are Maintenance Free (MF)		10-1450 AGM 27 10-0761 Flooded 31	10-5184 Dual Battery Kit (contains heavy duty jumper wires and additional battery box)	

BACKUP SYSTEMS

# Zoeller Backup Systems

## 540 FLEX<sup>®</sup> WATER-POWERED BACKUP PUMP

### Water-Powered Emergency Backup Sump Pump System

Zoeller's FLEX<sup>®</sup> is a high capacity, high efficiency, water-powered backup system. The FLEX<sup>®</sup> takes over seamlessly when your primary sump system fails. Horizontal OR vertical installation capability allows FLEX<sup>®</sup> to fit most sump applications.



**3** YEAR  
WARRANTY

BACKUP SYSTEMS

#### APPLICATIONS:

- Continuous pumping during power outage using city water pressure.

#### SPECIFICATIONS:

- No electricity or batteries required
- Municipal/city water pressure powered system
- Unit requires 3/4" inlet line to operate properly
- Adaptable to 1-1/4" or 1-1/2" suction pipe
- Engineered for trouble-free operation
- Non-corrosive materials
- Removes up to 2 gallons for every gallon used

For more information, see Technical Data Sheet FM3169

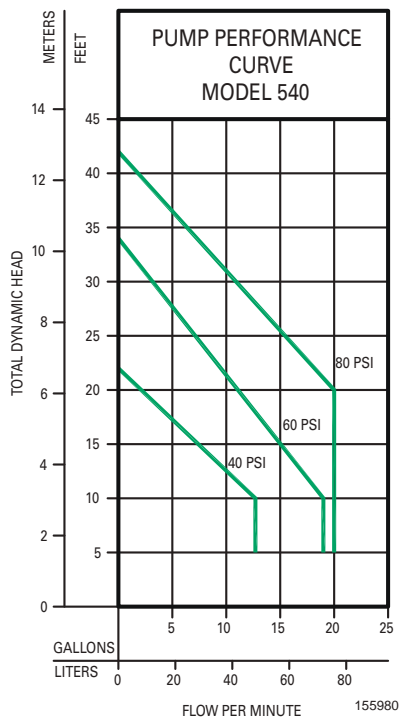

Horizontal Installation



Vertical Installation

# 212

The Model 212 offers accessible quality for the cost conscious. This submersible pump is designed for use in residential or light commercial sewage applications and can be used to transfer groundwater, effluent, or sewage. The pump includes a cast iron motor housing with a corrosion-resistant, baked-on enamel finish and is designed to provide great heat dissipation from the motor, ensuring a long service life.

**APPLICATIONS:**

- Residential sewage
- Water transfer and dewatering
- New construction

**SPECIFICATIONS:**

- 2" NPT discharge
- 1/2 HP
- 2" (50 mm) spherical solids capacity with non-clogging engineered plastic vortex impeller

For more information, see Technical Data Sheet FM2850.



Product may not be as pictured.

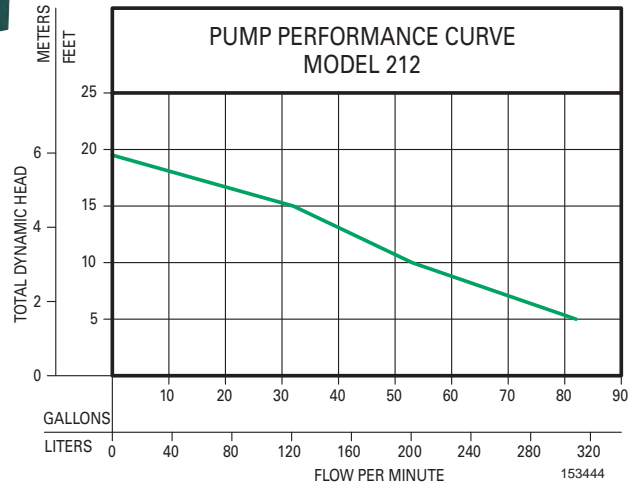

# 264, 266, 267, 270

## Waste-Mate

Considered one of America's most popular sewage ejectors, this robust family of pumps is known for reliability, durability and performance. These pumps are industry-proven, built of cast iron with stainless steel hardware. Comes with an integral, 2-pole, snap-action float switch. The heat-dissipating cast iron body with powder coated epoxy finish provides maximum pumping performance under the most extreme conditions. With a cool run design, the hermetically sealed, oil-filled motor and non-clogging vortex impeller add up to a long-lasting, trouble-free product.

**APPLICATIONS:**

- Residential and light commercial sewage and dewatering
- New construction
- Wastewater / lift stations

**SPECIFICATIONS:**

- 2" NPT discharge
- 4/10 HP through 1 HP
- Available in automatic or nonautomatic
- 2" (50 mm) spherical solids capacity with vortex thermoplastic impeller on model 270, cast iron impeller on models 266 and 267
- Models 266 and 267 available in 3 phase voltages

For more information, see Technical Data Sheets FM2788, FM2789, FM2790.



SEWAGE, DEWATERING

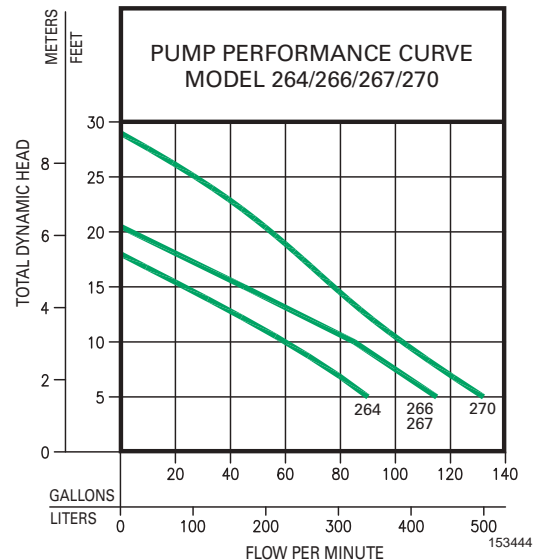

# 282, 284

## Waste-Mate

Heavy duty construction, oversized bearings and balanced non-clogging vortex impellers allow these pumps to stand up to the highest heads and maximum flows. Using Zoeller's cool run design, we added fins to these pumps, lowering operating temperatures. The corrosion-resistant, powder coated epoxy finish and hermetically sealed, oil-filled motor add up to a long-lasting, trouble-free product.

### APPLICATIONS:

- Commercial sewage and dewatering
- Wastewater
- Lift stations



### SPECIFICATIONS:

- 2" or 3" NPT flanged vertical discharge
- 1/2 HP and 1 HP
- Available in automatic or nonautomatic
- 2" (50 mm) spherical solids capacity with cast iron vortex impeller
- Thermally protected motor
- Double shaft seal versions available for added protection

For more information, see Technical Data Sheet FM2791.



009927A

# 292, 293, 294, 295

## Waste-Mate

Heavy duty construction, oversized bearings and balanced non-clogging vortex impellers allow these pumps to stand up to the highest heads and maximum flows. Using Zoeller's cool run design, we added fins to these pumps, lowering operating temperatures. The corrosion-resistant, powder coated epoxy finish and hermetically sealed, oil-filled motor add up to a long-lasting, trouble-free product.

### APPLICATIONS:

- Commercial sewage and dewatering
- Wastewater
- Lift stations

### SPECIFICATIONS:

- 2" or 3" NPT flanged vertical discharge
- 1/2 HP through 2 HP
- Available in automatic or nonautomatic
- 2" (50 mm) spherical solids capacity with cast iron vortex impeller
- Thermally protected motor
- Double shaft seal versions available for added protection

For more information, see Technical Data Sheet FM2792.

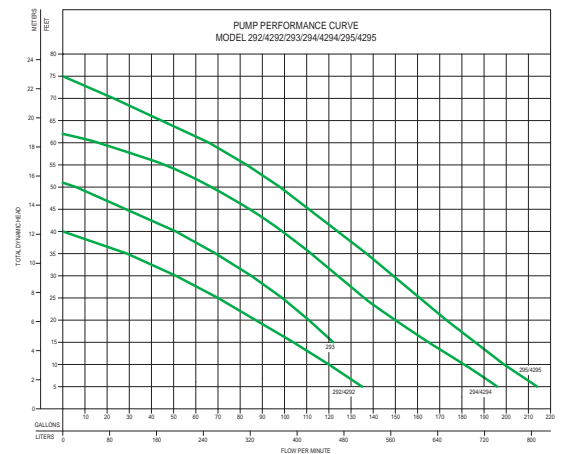

009919A

# 4404, 4405

## Waste-Mate

Designed to handle large solids and high flow rates, these pumps are ideal for quickly removing water as well as raw waste. Suited for parking lots and storm water transfer, the oversized bearings and balanced non-clogging vortex impellers allow these pumps to meet the most demanding applications. Using our cool run design, we added fins to these pumps, lowering operating temperatures. The corrosion-resistant, powder coated epoxy finish and hermetically sealed, oil-filled motor add up to a long-lasting, trouble-free product. Rail systems are available for ease of installation and removal.



### SPECIFICATIONS:

- 4" ANSI flange discharge
- 2 and 3 HP
- Double shaft seal versions available for added protection
- Thermally protected motor

For more information, see Technical Data Sheet FM2793.

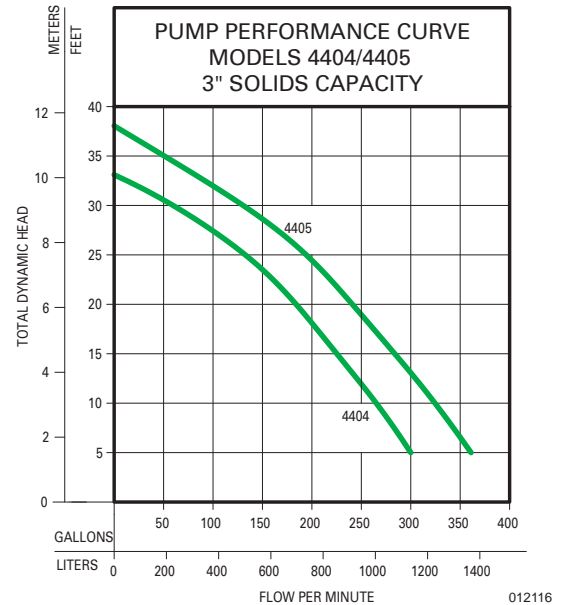

# 611, 621, 631, 641, 651, 661

## Sewage Waste

Engineered for large commercial and industrial applications, these pumps utilize extended vane ductile iron impellers for improved efficiency and performance. The tandem seal design provides additional protection from abrasives typically found in demanding applications. Cooling fins, not commonly found in this type of pump, lower operating temperatures, providing longer motor and bearing life. Rail systems are available for ease of installation and removal.



### APPLICATIONS:

- Industrial and commercial wastewater
- Storm water removal
- Engineered lift stations

### SPECIFICATIONS:

- 3" NPT vertical or 3" or 4" ANSI flange discharge
- 1 HP through 7-1/2 HP
- 2-1/2" (64 mm) spherical solids capacity with cast iron, two vane, semi-open impeller
- Hazardous location/explosion proof, nonautomatic version also available
- Double shaft seal for added protection

For more information, see Technical Data Sheet FM2794.

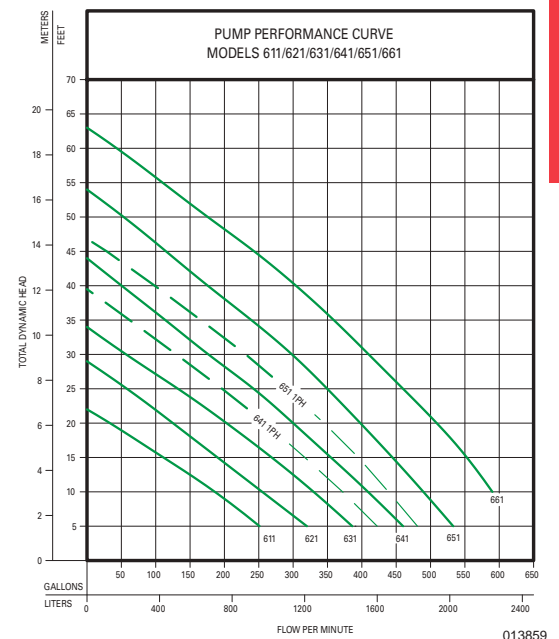

SEWAGE, DEWATERING

# 803, 805, 807

## Grinder Pumps

Fractional HP Grinder Series. World's first integral automatic grinder. All cast iron grinder series for difficult residential applications where ejectors struggle. Handles entire household of "flushable" materials. Available in 115V or 230 volt for residential use without commercial costs.

U.S. Patent No. 8,562,287

### APPLICATIONS :

- Residential wastewater
- Light commercial

### SPECIFICATIONS:

- 1-1/4" NPT discharge
- 803 - 1/2 HP, 805 - 3/4 HP, 807 - 1 HP
- Cast iron construction
- Oil-filled for optimal heat dissipation
- Thermally-protected motor

For more information, see Technical Data Sheet FM2882.



Available in package systems.  
See page 27



915-0020 and 915-0022  
shown, left to right

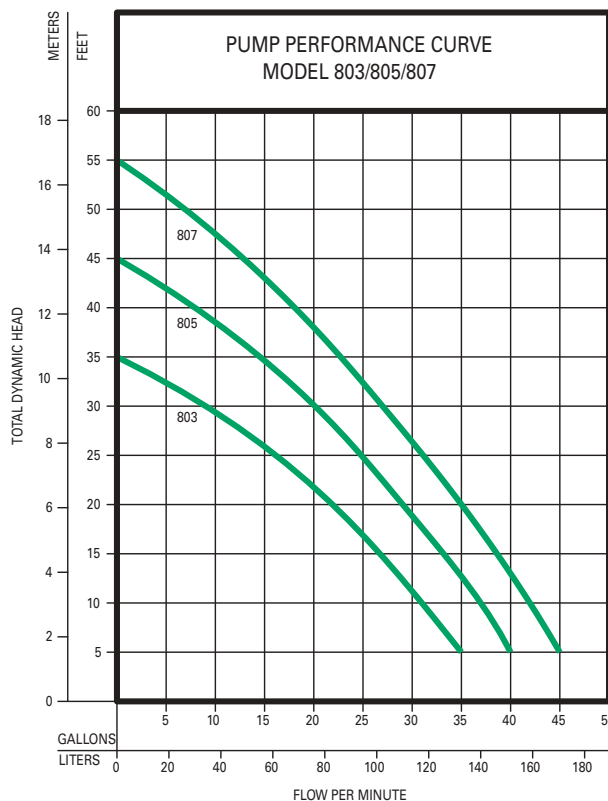

153604

# 810, 815

## Progressing Cavity Grinder Pump

Designed for high pressure sewer systems, our Shark® Series progressing cavity grinder pumps offer a head capacity up to 240 feet (73 m). Constructed of corrosion-resistant cast iron with a powder coated epoxy finish and stainless steel hardware, these pumps are built for years of reliable service. The thermally protected, oil-filled motor and external cooling fins allow the pump to run cooler. An internal pressure relief valve protects the motor and hydraulic components from extreme spikes in sewer pressure. The hardened stainless steel Tri Slice® cutter provides scissor-action style cutting to virtually eliminate binding and roping of material around the cutter.



### SPECIFICATIONS:

- 1-1/4" NPT discharge
- 1 and 2 HP
- Rockwell C55-60 hardened 440C stainless steel cutter and disc

For more information, see Technical Data Sheet FM2796.

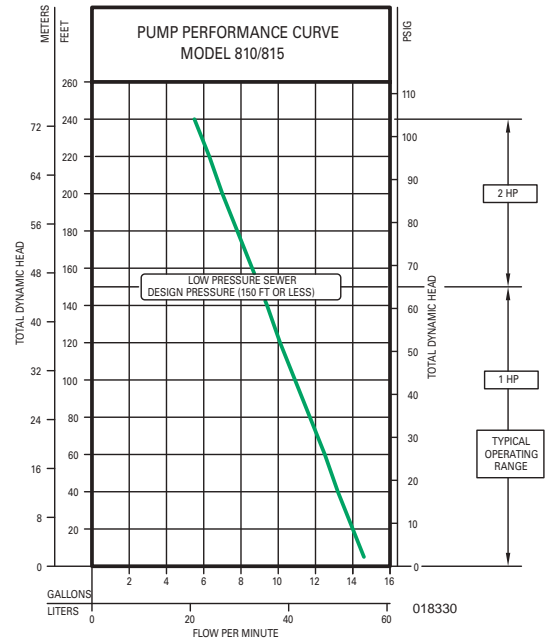

### APPLICATIONS:

- Residential sewage removal for pressure sewer systems
- Pressure sewer systems



# 818, 820

## Grinder Pumps 1.0 & 2.0 HP

This pump is constructed of corrosion-resistant cast iron with a powder coated epoxy finish and stainless steel hardware. The hardened stainless steel Tri-Slice® cutter provides scissor-action style cutting that helps eliminate binding and roping of material around the cutter. The thermally protected, oil-filled motor and external cooling fins allow the pump to run cooler. Available in single phase and three phase configurations.



Tri-Slice®, two-bladed, high-torque cutter

U.S. Patent No. 8,562,287

### APPLICATIONS:

- Residential and light commercial sewage grinder applications
- Pressure sewer systems

### SPECIFICATIONS:

- Tri-Slice®, two-bladed, high-torque cutter
- Scissor-style cutting action shreds solids down to 7/32" (5 mm) and smaller
- 1-1/4" NPT discharge
- Rockwell C55-60 hardened 440C stainless steel cutter and disc
- Vortex impeller

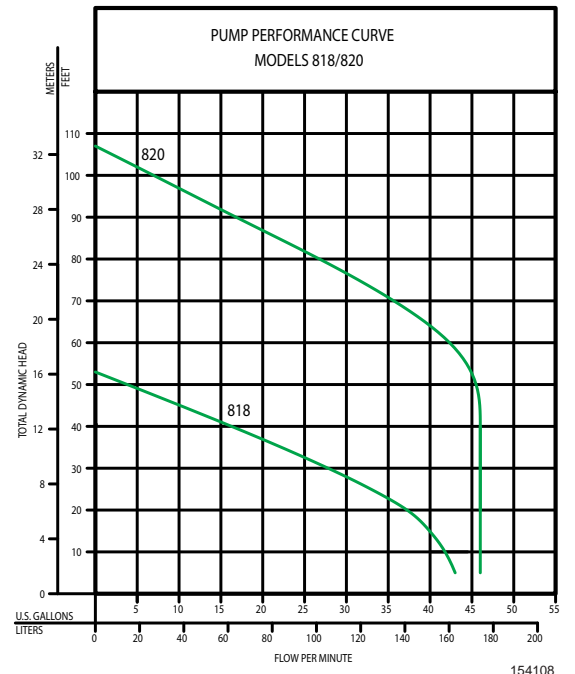

GRINDER PUMPS

# 840, 841

## 2 HP Grinder Pumps, Reversing & Single Directional

Constructed of corrosion-resistant cast iron with a powder coated epoxy finish and stainless steel hardware, built for years of reliable service. The thermally protected, oil-filled motor and external cooling fins allow the pump to run cooler than most. The hardened 440C stainless steel star shaped cutter provides scissor-action style cutting that helps eliminate binding and roping of material around the cutter. The 840 Shark® offers the industry's only automatic, reversing impeller and cutter assembly that virtually doubles the service life of ordinary grinder.

### APPLICATIONS:

- Residential, commercial and municipal sewage grinder pump systems
- Pressure sewer systems



### SPECIFICATIONS:

- Double shaft seal for added protection
- Moisture detection and temperature protection
- 1-1/4" NPT discharge
- Model 840 AUTO-REVERSING star-cutter eliminates clogging
- Rockwell C55-60 hardened 440C stainless steel cutter and disc
- Vortex impeller
- Hazardous location/explosion proof version available

For more information, see Technical Data Sheet FM2799.

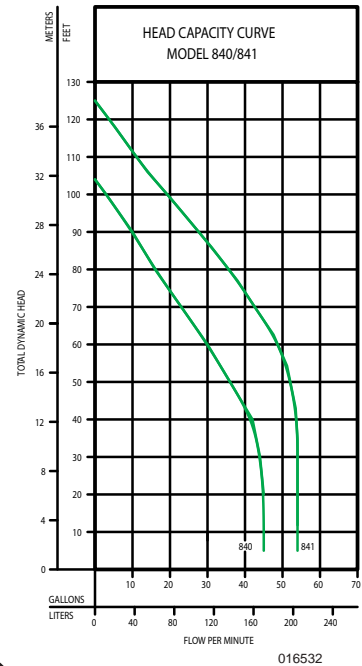

# 932

## Simplex Replacement Grinder

The Progressing Cavity Grinder Replacement Pump easily adapts to a competitors' system. The oil-filled, hermetically sealed, cool run motor design and hardened stainless steel cutter ensure long life and minimal maintenance. Unit comes completely assembled with check valve, anti-siphon valve, pressure relief valve, quick disconnect plumbing coupling and electrical receptacle fitting. Includes high level alarm as an added convenience.

### APPLICATIONS:

- Retrofit for existing progressing cavity grinder systems
- Pressure sewer systems

### SPECIFICATIONS:

- 1-1/4" NPT discharge
- Bolts to existing progressing cavity grinder pump systems
- Rockwell C55-60 hardened 440C stainless steel cutter and disc

For more information, see Technical Data Sheet FM2465.

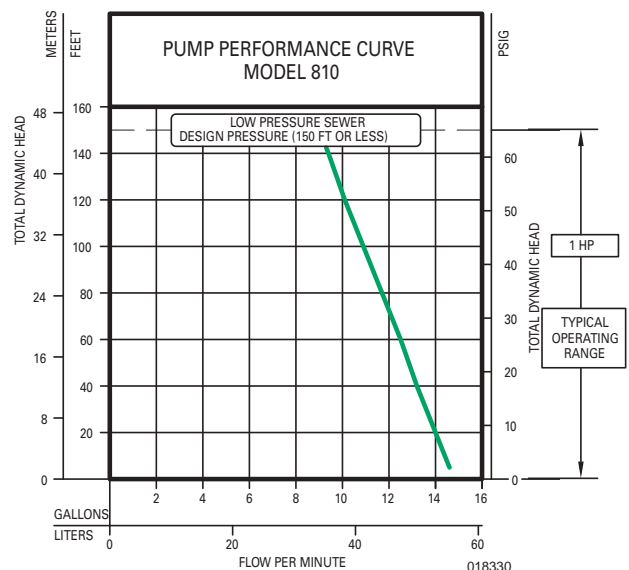
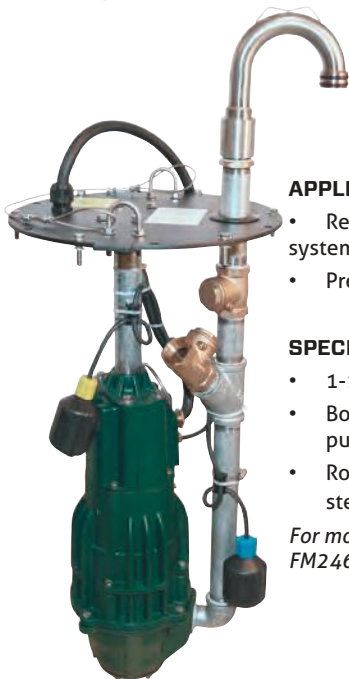

# 912/915 Package Systems

## Simplex Sewage Package Systems (job ready/preassembled)

### SPECIFICATIONS:

- More choices, easier installation and fast delivery
- Saves labor and reduces installation errors
- 2" (50 mm) solids-handling pump
- 2" PVC discharge pipe, 30" (76 cm) long on 18" x 30" (46 x 76 cm), 24" (61 cm) long on 24" x 24" (61 x 61 cm) and 36" (91 cm) long on 24" x 36" (61 x 91 cm)
- Basins - polyethylene, poly-foam or fiberglass construction with poly or solid steel covers and 4" pipe seal hub, 4" PVC hub (deluxe) or 4" cast iron hub on L.A. Code Systems
- Check valve options - 30-0151, 30-0020, 30-0021, 30-0101 or 30-0103 (not included)
- Systems available with alarms and preinstalled alarm float.
- Premium indoor systems have a split cover for easy pump inspection, torque stops and an anti-flotation device.
- Side discharge systems rated for outdoor burial: solid polyethylene structural foam lid and basin with 2" discharge on side
- 3/16" (5 mm) vent hole drilled



912-0007 shown

See FM3467 or FM2953 for further information.

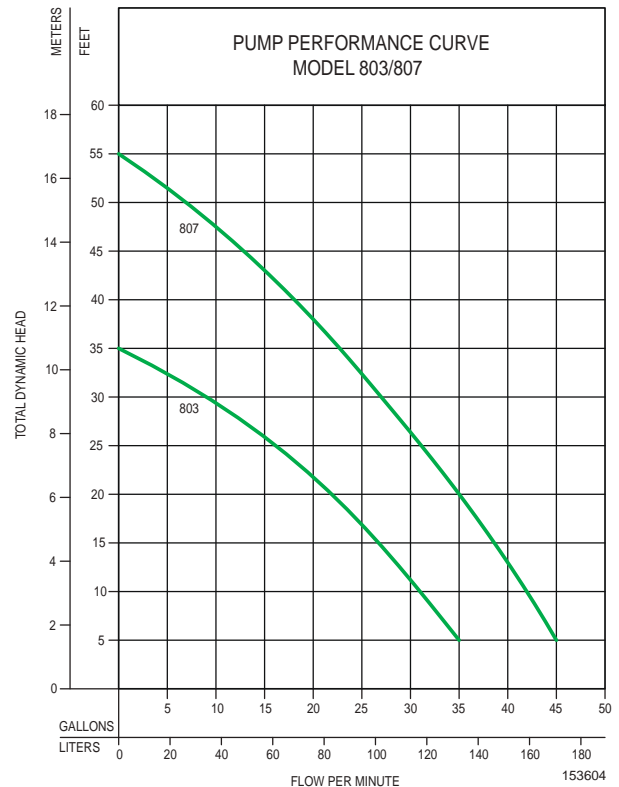
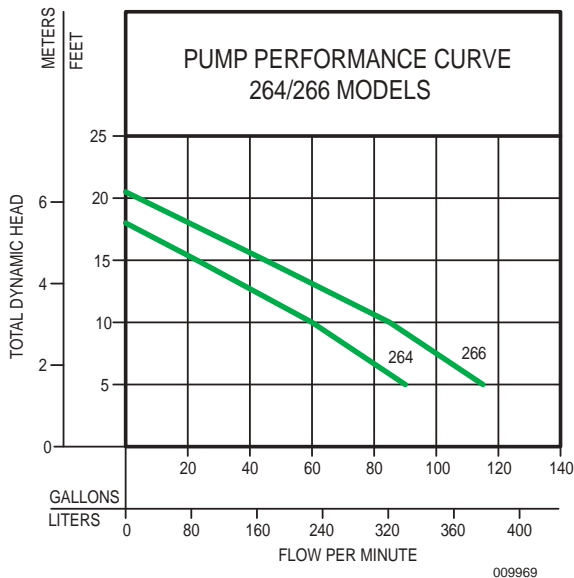

## QLS SERIES

PREFABRICATED LIFT STATIONS WITH Z-RAIL® TECHNOLOGY

Complete effluent sewage or grinder package systems are factory assembled for quicker, easier installation at the jobsite. Zoeller's Z-Rail® Technology with powder coated, ductile iron elbows and brackets provides longer life and reliability. Dual-rail system offers added support and stability while raising and lowering pumps compared to single-rail systems. A wide variety of basin diameters and depths are stocked to accommodate almost any job. Cover choices include solid fiberglass and either steel or aluminum hatches.

### Z-Rail® System

Both the disconnect portion and the upper guide rail supports are made of domestic epoxy powder coated ductile iron, providing superior strength. Dual guide rails add stability, ensuring that the pump will not spin on the rail during installation or removal.

### Basin

Zoeller Company stocks many different basin and cover options to fit a multitude of wastewater collection projects. Basin sizes from 24" x 48" to 48" x 120" meet most application needs. Customized packages available.

### Basin Cover

Solid fiberglass, aluminum hatch, and steel hatch covers are stocked for QLS Series® packages.

### Three Way Ball Valve

The QLS Series® systems utilize a 3-way ball valve in duplex configurations. The valve is positioned so that the service providers can easily isolate pumps without entering the basin.

### Pipe Seal Hub

A 4" pipe seal is provided as a convenient field-installed inlet hub.

### AFD

QLS Series® basins come with an anti-floatation collar to resist buoyancy in high groundwater locations.

### Flex-Boot Discharge Connection

A flexible, stable discharge seal remains watertight despite external pressures due to pipe settling.

### Schedule 80 PVC Piping

Schedule 80 PVC discharge piping provides greater support and dependability with its thicker walls and higher pressure rating.

### Engineered Lift Stations

Zoeller offers a complete line of prepackaged and preassembled lift stations using sump, effluent, sewage or grinder pumps! Utilizing everything from a small 1/2 HP pump to the large 7-1/2 HP non-clogging pump, Zoeller will prefabricate any lift station as an engineered factory built system. The headache of keeping track of product compatibility is eliminated, and the contractor is ensured that each system's components will properly operate with one another, and simplify installation.

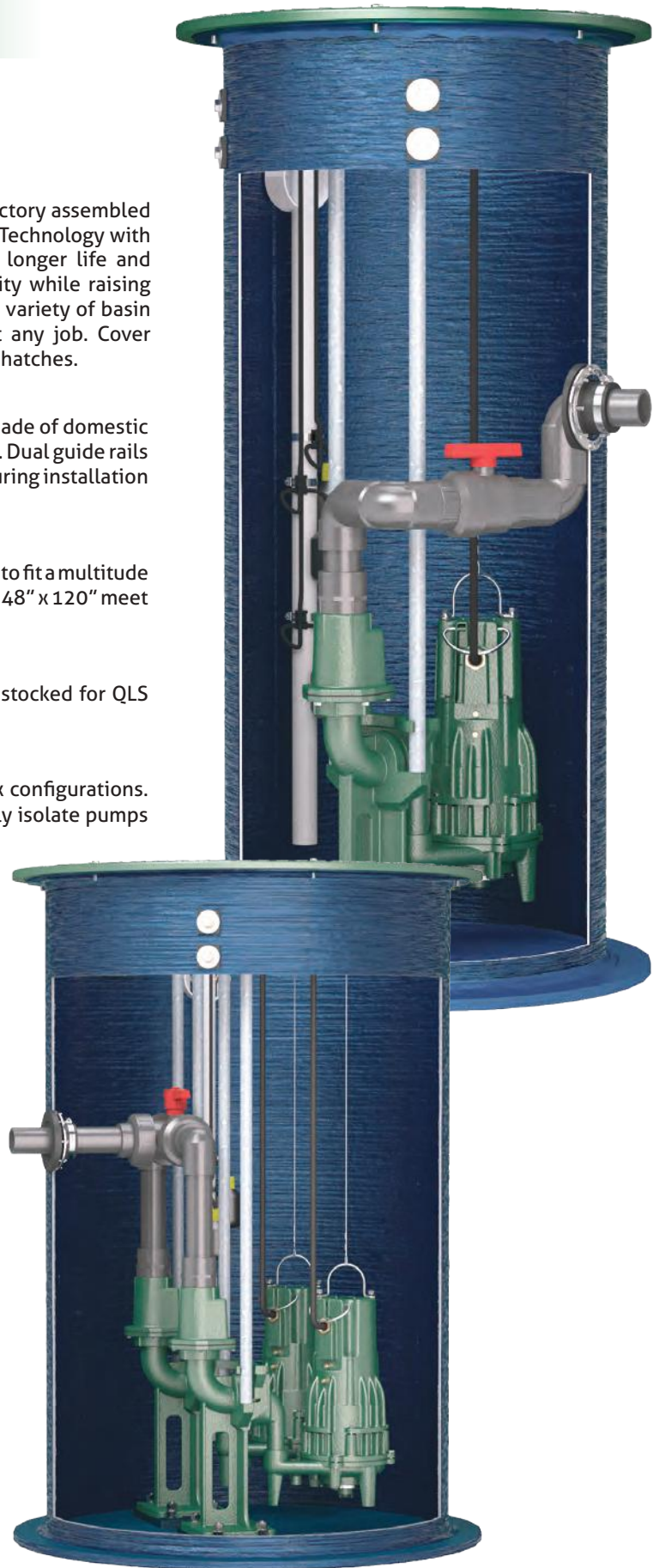

# Condensate Pumps

## Model 519 and Model 522

This fully automatic, easily installed, condensate pump removes condensation from air conditioning equipment, condensing furnaces, dehumidifiers, ice makers, water coolers and refrigeration systems.

### APPLICATIONS:

Automatically removes condensation from a variety of systems including air conditioning units, dehumidifiers and refrigeration systems.

### SYSTEM INCLUDES:

- Handles condensate up to 140 °F (60 °C)
- 20 ft (6.1 m) TDH
- Wall mounts
- Four inlet options (Model 519), two inlet options (Mode 522)
- 3/8" Discharge
- Stainless steel shaft
- Built-in safety switch and check valve
- 6 ft power cord with ground
- Thermally protected
- Option available to include 20' of 3/8" clear tubing
- Built-in check valve
- Safety switch and alarm indicator lights
- Oversized reservoir

For more information, see Technical Data Sheet FM2808.



Model 519



Model 522

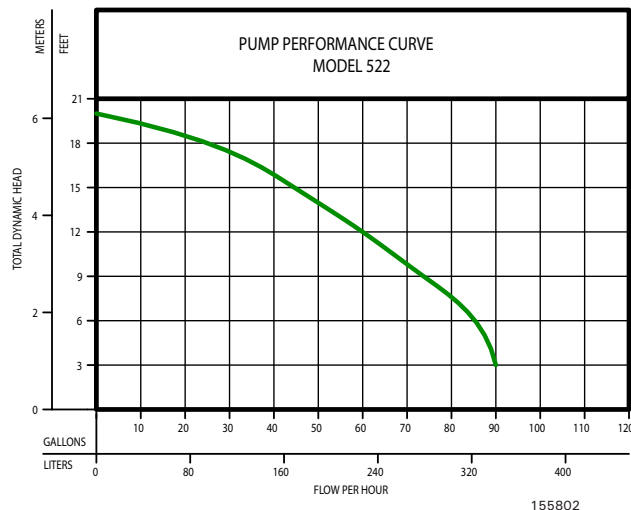
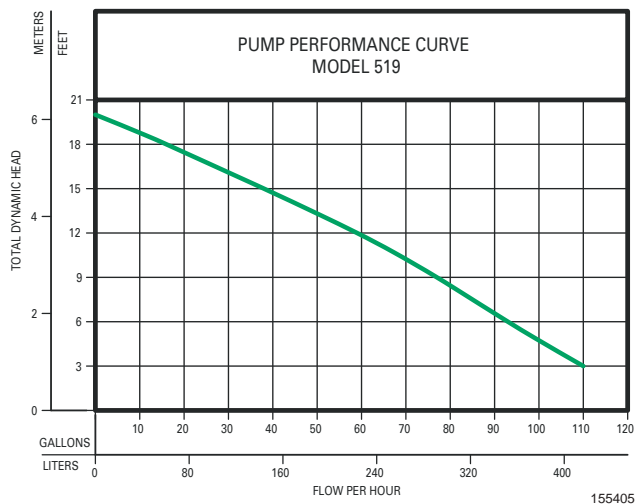

# Qwik Jon® Upflush Systems

## Add a bathroom almost anywhere without breaking concrete!

- Allows adding a bathroom in previously unplumbed locations
- Easy to install as a freestanding unit or as a discrete installation behind the wall
- Collects used water from all fixtures including sinks, faucets, tubs, showers, and more
- Automatic reset protects the pump from thermal overload
- No gravity drain required
- Non-clogging vortex impeller for reliable operation
- Smooth surface for easy cleaning

## Qwik Jon® PREMIER

Patent No.: US 11,905,695 B2

### SPECIFICATIONS:

- A quiet, preassembled 1/2 HP grinder pump system
- Carbon/ceramic mechanical shaft seal for long life  
Upper and lower ball bearings for efficient and quiet operation
- Non-clogging vortex impeller for reliable operation
- Withstands total immersion (IP68)
- 1" Discharge elbow with built-in check valve
- Standard 6' (1.8 m) cord with right angle plug
- Tri-Slice® Cutter Technology - three independent cutting channels provide over 250,000 cuts per minute
- Premium investment-cast 440C stainless steel cutter and cutter plate
- Flushables: toilet paper, organic waste, and sanitary items
- For residential and light commercial applications



PN# 201-0006  
(UNIT ONLY, toilet sold separately)

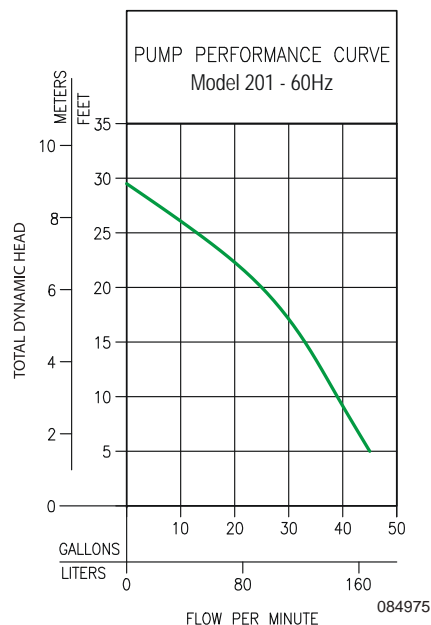

10-5090 Qwik Alarm™  
for Qwik Jon® Premier

**Qwik Alarm™ (Model 10-5090)** - for use on the Premier where a separate vent is used.

- An audible alarm that alerts when the tank water level is high
- Convenient snap-fit cover provides easy access to alarm settings and the battery compartment
- Smooth white polypropylene case that is easy to clean
- Preassembled alarm and seal for quick and easy installation
- Low profile, compact design blends in well in a bathroom setting
- IPX8 rated device that can withstand periods of total immersion, so it is ideal for damp areas

# Qwik Jon® Upflush Systems

## Qwik Jon® CHOICE

### SPECIFICATIONS:

- A quiet, preassembled 1/3 HP pump and macerator system
- Carbon/ceramic mechanical shaft seal for long life
- Upper and lower ball bearings for efficient and quiet operation
- Non-clogging vortex impeller for reliable operation
- Recessed side handles for carrying
- Convenient snap-fit covers for easy access to macerator and electrical junction box
- Discharge elbow with built-in check valve
- Standard 6' (1.8 m) cord
- Flushables: toilet paper and organic waste
- For residential applications

For more information, see Technical Data Sheet FM3343.

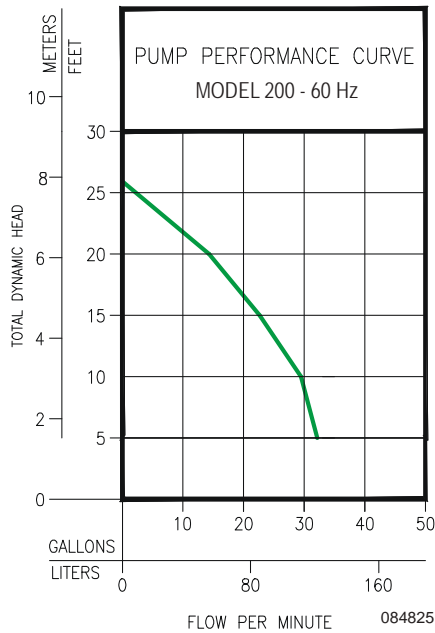

P/N# 200-0006 (QJC ONLY, toilet sold separately.)



202-3003 Qwik Jon Toilet Tank and Lid.  
202-3002 Elongated Toilet Bowl.



\*Model 1.28 only



### Qwik Jon® Toilet (Model 202) - for all Qwik Jon® models.

- ADA compliant elongated bowl
- EPA Water Sense compliant toilet with 1.28 gallon (4.8 l) per flush Includes flush handle, fill and flush valve
- Rear spigot toilet for direct connection to any Qwik Jon® model.

### For a complete system, order:

201-4000 - (includes the Qwik Jon Premier and toilet) delivered in three boxes.

200-4000 - (includes the Qwik Jon Choice and toilet) delivered in three boxes

**Optional Extension Kit (Model 10-3050) - for recessed or behind-the-wall installations. Can be used with all Qwik Jon® models**

OTHER PRODUCTS

# Drain Pump Systems



Unassembled Model 131

These are our most versatile water collection systems. No need to dig a sump pit or re-route plumbing drain lines. This compact system includes everything you need to remove water from areas without gravity drains. Excellent for bar sinks, laundry trays or condensate removal. There are no inlet filters to clean, and easy compression fittings make for quick and trouble-free installations. As an added bonus, the P-trap can be located inside the tank if necessary.

#### APPLICATIONS:

- Under bar
- Beauty salon / parlors
- Work sinks
- Laundry trays



#### SPECIFICATIONS:

- 1-1/2" NPT discharge with 1-1/2" threaded vent
- 5 gallon (19 liter) capacity poly basin
- Includes 1-1/2" check valve

For more information, see Technical Data Sheet FM2801.

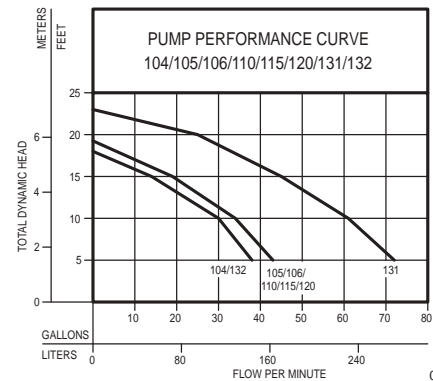

009898

	104	105	106	110	115	120	131	132
<b>Preassembled</b>	N	Y/N	N	N	N	N	N	Y
<b>Pump Model</b>	M72	M53	M63	M55	M57	M59	M98	M72
<b>Pump Construction</b>	Engineered plastic	Cast iron with plastic base	All cast iron	Bronze with plastic base	All cast iron	All bronze	All cast iron	Engineered plastic
<b>HP</b>	1/3	3/10	3/10	3/10	3/10	3/10	1/2	1/3
<b>AMPS</b>	3.1	9.7	9.7	9.7	9.7	9.7	9.4	3.1
<b>RPM</b>	3400	1550	1550	1550	1550	1550	1725	3400
<b>Solids passing</b>	3/8" (9 mm)	1/2" (12 mm)	1/2" (12 mm)	1/2" (12 mm)	1/2" (12 mm)	1/2" (12 mm)	1/2" (12 mm)	3/8" (9 mm)
<b>Max temp.</b>	110 °F (43 °C)	130 °F (54 °C)	130 °F (54 °C)	130 °F (54 °C)	130 °F (54 °C)	130 °F (54 °C)	130 °F (54 °C)	110 °F (43 °C)
<b>Cord length</b>	9' (2.7 m)	9' (2.7 m)	9' (2.7 m)	9' (2.7 m)	9' (2.7 m)	9' (2.7 m)	15' (4.6 m)	9' (2.7 m)
<b>Check valve</b>	All systems include a check valve (except Model 104). Preassembled systems include a space-saving, internal check valve threaded into the discharge of the pump.							
<b>Warranty</b>	2yr	3yr	5yr	1yr	3yr	1yr	3yr	2yr

## Moisture and Mold Protection

This system is designed specifically with tight or restricted spaces in mind. Indoors or outdoors, eliminate standing water from areas without proper drainage. Prevent the accumulation of moisture, fungus, and odors commonly found in residential crawl spaces. The perforated basin and solid lid keep large debris from entering the pit, eliminating maintenance.

### APPLICATIONS:

- Dewatering in crawl spaces
- Dewatering under mobile homes

### SYSTEM INCLUDES:

- Automatic pump
- 24' (7 m) hose
- Tank assembly
- Check valve

For more information, see Technical Data Sheet FM2802.

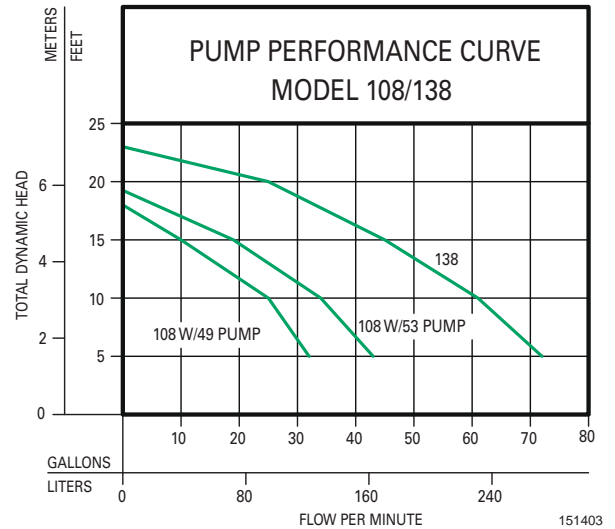

## 109 Scale Removal Series

### SRS<sup>®</sup> SCALE REMOVAL SYSTEM

This preassembled system is engineered to meet the flushing requirements of tankless water heaters. An internal, reusable filter sock captures debris removed from the pipe system. A durable, air-filled 1/6 HP submersible pump and 3/4" stainless steel braided flush lines ensure quality and reliability for years of trouble-free performance. Recommended by professionals job after job, this system is an ideal and economical tool for plumbing contractors who install and service tankless water heating systems.

Patent pending

### APPLICATIONS:

- Removes line build-up in tankless water heating units

### SYSTEM INCLUDES:

- 1/6 HP pump
- Stainless steel braided hoses
- Poly tank with sealed cover
- Fittings

For more information, see Technical Data Sheet FM2807.

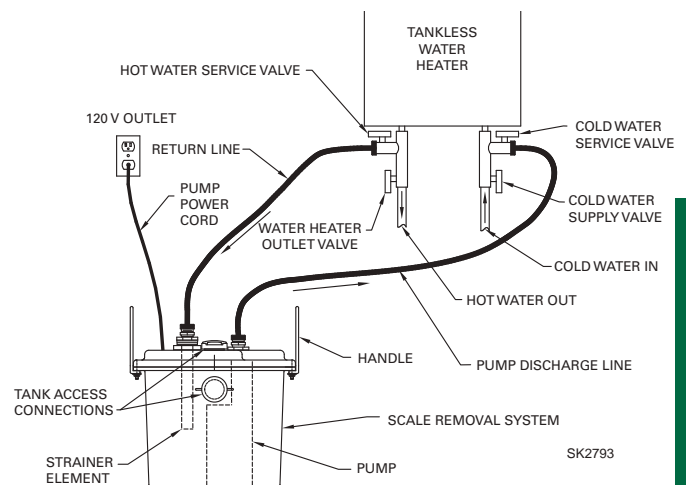

# Oil Guard® Systems

Engineered to recognize the difference between water and oil, these systems help protect the environment and equipment from the dispersion of oils and/or hydrocarbons by only pumping water. They are perfect for elevator sumps, transformer vaults, or other applications where there is a need to remove water containing oil. Independently verified by OnSpeX, division of CSA, the Oil Guard® includes one of four pump models, Oil Smart® Pump Switch and alarm. Multiple features and options are available including NEMA-4X alarm panel enclosure, audible and light alarms and dry contacts. Turn this product into a connected device using the Z Control® Cloud. Monitor dry contacts to receive email, text, and push notifications.

## APPLICATIONS:

- Elevator vaults
- Transformer vaults
- Boat hulls

## SPECIFICATIONS:

- NEMA 4X alarm panel includes dry contacts for remote alarm
- Elevator systems require a minimum 50 GPM (189 LPM) and a maximum 6' (2 m) pump cord
- Custom systems available

For more information, see Technical Data Sheet FM2809.



For complete product information, visit:  
[zoellerpumps.com](http://zoellerpumps.com)



10-2149  
Simplex panel



10-2150  
Duplex panel

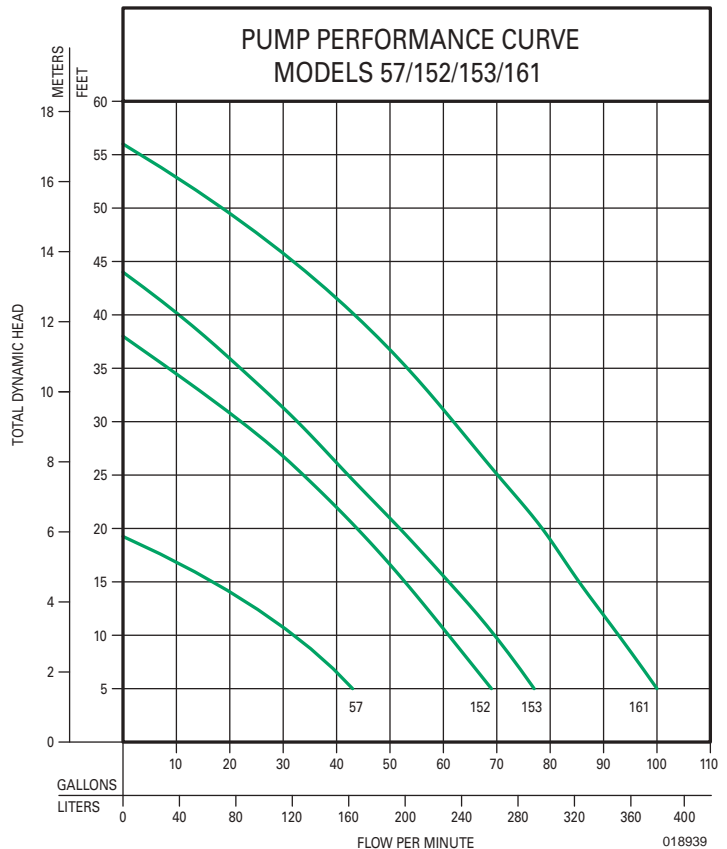

# High-Temp Pumps

This series of submersible pumps is designed for use in residential or commercial dewatering applications and can be used to transfer groundwater and wastewater. These durable cast iron pumps include a powder coated epoxy finish to prevent corrosion and are designed to meet specifications with assurance by using high temperature parts rated for continuous 200 °F (93 °C) contact. Available in a variety of models and performances, each pump is 100% factory tested to ensure quality and reliability for years of trouble-free performance! This attention to detail is an inherent feature of every model in this pump series, making it one of the most reliable in the industry.

## APPLICATIONS:

- Commercial laundry facilities
- Boiler blow down application
- Maintenance facilities

## SPECIFICATIONS:

- 2000 Series rated for intermittent 200 °F (93 °C)
- 3000 Series rated for continuous 200 °F (93 °C)
- 1-1/2" – 3" NPT discharge
- 3/10 HP through 1/2 HP
- Available in automatic or nonautomatic

For more information, see *Technical Data Sheet FM2811*.



Model 2057



Model 3098

# Agricultural

## Models 4290 and 4291 High Head Pump

This series of submersible sewage pumps is designed for use in agricultural applications, lagoon recirculation systems, and sump pit systems. These durable cast iron pumps include a powder coated epoxy finish to prevent corrosion and a hermetically sealed, oil-filled motor housing that provides great heat dissipation and keeps the pumps running cooler. The non-clogging vortex impeller design reduces the risk of clogging and provides great solids passing capability.

## APPLICATIONS:

- Specifically designed for lagoon or sump pit applications
- Farming industry
- Agricultural industry

## SPECIFICATIONS:

- 2" NPT discharge (available with 3" NPT bolt-on flange)
- 1/2 HP through 1 HP
- Available in automatic or nonautomatic
- 1-1/2" (38 mm) spherical solids capacity with bronze vortex impeller
- Tandem seals with silicon carbide/silicon carbide lower seal and carbon/silicon carbide upper seal

For more information, see *Technical Data Sheet FM2812*.

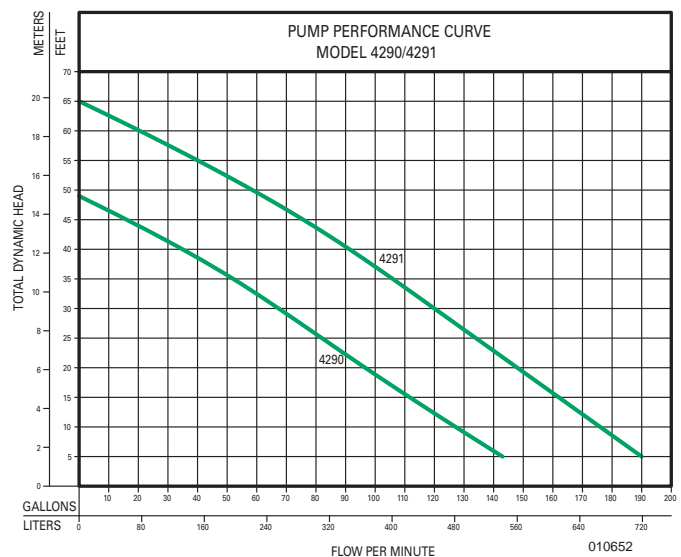

OTHER PRODUCTS

# Aeration/Fountain

## Model 370

This aeration and fountain pump adds a unique focal point and value to your property. The environmentally friendly, water-cooled motor eliminates pollution risk and pond contamination. The continuous-duty pump operates in 5' (1.5 m) or more of water and aerates up to 4,900 gallons (22,276 L) per hour. It produces a water fountain up to 15' (5 m) in height, and it includes three easily interchangeable patterns. The flotation system incorporates a UV-resistant, polyethylene float and eye-bolts for anchoring.

### APPLICATIONS:

- Golf courses
- Subdivisions
- Office parks
- Reduces mosquitoes
- Helps eliminate stagnant water

### SPECIFICATIONS:

- Preassembled with 100' (30 m) GFCI protected power cord

For more information, see Technical Data Sheet FM2813.



# Technical Specs

## UTILITY, PEDESTAL

See pages 3, 4

Model	HP	Discharge	Volts	Ph	Operation	Std. Cord Length	Width	Height	Weight	Gallons per minute (GPM) @ Height						Shut Off (ft.)
										5 ft.	10 ft.	15 ft.	20 ft.	25 ft.	30 ft.	
42	1/6	1"	115	1	Non	9 ft.	6"	9-1/2"	7.3	15	11	6	--	--	--	19
44/LM44	1/4	1"	115	1	Non	9 ft.	6"	11-3/4"	7.7/8.7	30	22	12	--	--	--	20
46	1/2	2"	115	1	Non	9 ft.	8"	14-1/2"	16	55	47	37	25	5	--	33
311	1/2	hose	115	1	Non	6 ft.			7.75	Maximum flow @ 1 ft. Head = 5.6 GPM						39
314	1/2	hose	115	1	Non	9 ft.			17	21	20	19	--	--	--	23
81	1/3	1-1/4"	115	1	Auto	7-1/2 ft.	9.55	31-1/4"	15	50	36	10	--	--	--	16
82	1/3	1-1/2"	115	1	Auto	7-1/2 ft.	9.55	31-3/4"	19	52	41	12	--	--	--	17
84	1/2	1-1/2"	115	1	Auto	7-1/2 ft.	9.55	32-1/2"	22.5	59	51	38	17	--	--	24

## SUMP, EFFLUENT, DEWATERING

See pages 5-10

Model	HP	Discharge	Volts	Ph	Operation	Double Seal Option	Auto Std. Cord Length	Width	Height*	Gallons per minute (GPM) @ Height											Shut Off (ft.)	
										5 ft.	10 ft.	15 ft.	20 ft.	25 ft.	30 ft.	35 ft.	40 ft.	50 ft.	60 ft.	70 ft.		80 ft.
49	1/4	1-1/2"	115	1	Auto		9 ft.	8-3/32"	10-1/2"	32	25	10	--	--	--	--	--	--	--	--	--	18
53, 55, 57, 59	3/10	1-1/2"	115, 230	1	Auto/Non		9 ft.	10-3/32"	10-1/6"	43	34	19	--	--	--	--	--	--	--	--	--	19.25
63	3/10	1-1/2"	115	1	Auto		10 ft.	10-3/32"	10-1/6"	43	34	19	--	--	--	--	--	--	--	--	--	19.25
73	1/3	1-1/2"	115	1	Auto		9 ft.	8-3/32"	11"	38	30	14	--	--	--	--	--	--	--	--	--	18
75	1/2	1-1/2"	115	1	Auto		10 ft.	8-3/32"	12-3/8"	50	40	30	17	--	--	--	--	--	--	--	--	25
95	1/2	1-1/2"	115	1	Auto		15 ft.	10-1/8"	12"	80	68	50	28	5	--	--	--	--	--	--	--	26
98	1/2	1-1/2"	115, 230	1	Auto/Non		9 ft.	10-1/8"	12"	72	61	45	25	--	--	--	--	--	--	--	--	23
137, 139	1/2	1-1/2"	115, 200-230, 460	1, 3	Auto/Non		10 ft.	12-1/4"	12-3/4"	93	79	64	36	8	--	--	--	--	--	--	--	26
140	1	1-1/2"	115, 230	1	Non	✓	20 ft.	10-3/16"	12-13/32"	86	80	73	66	59	49	38	28	--	--	--	--	50
145	3/4	1-1/2"	115	1	Non	✓	20 ft.	10-3/16"	12-13/32"	56	55	53	57	48	48	40	35	26	16	--	--	74
										5 ft.	10 ft.	15 ft.	20 ft.	25 ft.	30 ft.	40 ft.	50 ft.	60 ft.	70 ft.	80 ft.	90 ft.	
151	1/3	1-1/2"	115, 230	1	Auto/Non		20 ft.	11"	16 1/2"	50	45	38	29	16	--	--	--	--	--	--	--	30
152	4/10	1-1/2"	115, 230	1	Auto/Non		20 ft.	11"	16 1/2"	69	61	53	44	34	23	--	--	--	--	--	--	38
153	1/2	1-1/2"	115, 230	1	Auto/Non		20 ft.	11"	16 1/2"	77	70	61	52	42	33	22	--	--	--	--	--	44
161	1/2	1-1/2" or 2" or 3"	115, 230, 200, 460	1, 3	Auto/Non	✓	20 ft.	12-3/4"	18-9/16"	100	93	86	79	71	62	45	20	--	--	--	--	56
163	1/2	1-1/2" or 2" or 3"	115, 230, 200, 460	1, 3	Auto/Non	✓	20 ft.	12-3/4"	18-9/16"	61	60	60	59	57	55	46	33	15	--	--	--	66
165	1	1-1/2" or 2" or 3"	230, 460	1, 3	Auto/Non		20 ft.	12-3/4"	18-9/16"	61	60.5	60.3	60	59	58	55	50	39	22.5	10	--	86.5
										5 ft.	10 ft.	20 ft.	30 ft.	40 ft.	50 ft.	60 ft.	70 ft.	80 ft.	90 ft.	100 ft.	110 ft.	
185	1	1-1/2" or 2" or 3"	230, 460	1, 3	Auto/Non		20 ft.	12-3/4"	18-9/16"	--	--	--	85	70	51	32	9	--	--	--	--	73
186	1-1/2	1-1/2" or 2" or 3"	230, 460	1, 3	Auto/Non	✓	20 ft.	12-3/4"	18-9/16"	58	58	58	58	58	58	58	52	45	30.5	16	4	114
188	1-1/2	1-1/2" or 2" or 3"	230, 200, 460	1, 3	Auto/Non	✓	20 ft.	12-3/4"	18-9/16"	145	140	128	116	103.5	90	71	51	28	2	--	--	91
189	2	1-1/2" or 2" or 3"	230, 200, 460	1, 3	Auto/Non	✓	20 ft.	12-3/4"	18-9/16"	145	140	130.5	120	109	97	85	69	51	34	17	--	110
										5 ft.	10 ft.	20 ft.	30 ft.	40 ft.	60 ft.	80 ft.	90 ft.	100 ft.	110 ft.	120 ft.	130 ft.	
191	2	1-1/2" or 2" or 3"	230	1	Non		20 ft.	12-3/4"	18-9/16"	45	45	45	45	45	45	45	45	40	30	20	10	137

\* Single Seal Units

NOTES:

- BN/BE Models available packaged with a piggyback variable level float switch.
- A double shaft seal available on 140, 160 & 180 series.

# Technical Specs

## SEWAGE & DEWATERING

See pages 11-14

Model	HP	Discharge	Volts	Ph	Operation	Double Seal Option	Std. Cord Length	Width	Height*	Gallons per minute (GPM) @ Height												Shut Off (ft.)
										5 ft.	10 ft.	15 ft.	20 ft.	25 ft.	30 ft.	40 ft.	50 ft.	60 ft.	70 ft.	80 ft.	90 ft.	
212	1/2	2"	115	1/2	Auto		10 ft.	9-7/8"	15-7/8"	82	53	32	--	--	--	--	--	--	--	--	--	19.5
264	4/10	2"	115, 230	1	Auto/Non		15 ft.	13-9/64"	14-3/4"	90	60	23	--	--	--	--	--	--	--	--	--	18
266, 267	1/2	2"	115, 230, 200, 460	1, 3	Auto/Non		10 ft./15 ft.	13-5/32"	14-9/32"	115	85	45	10	--	--	--	--	--	--	--	--	20.5
270	1	2"	115, 230	1	Non	✓	20 ft.	13-1/16"	15"	132	101	77	56	29	--	--	--	--	--	--	--	29
282	1/2	2" or 3"	115, 230, 200, 460	1	Auto/Non		10 ft./15 ft.	13-9/16"	18-13/16"	127	96	64	34	6	--	--	--	--	--	--	--	26
284	1	2" or 3"	230, 200, 460	1, 3	Auto/Non	✓	10 ft./15 ft.	13-9/16"	18-13/16"	179	157	133	106	73	42	--	--	--	--	--	--	35
292	1/2	2" or 3"	115, 230, 200, 460	1, 3	Auto/Non	✓	20 ft.	12-7/8"	18-9/16"	135	120	104	87	70	51	--	--	--	--	--	--	40
293	1	2" or 3"	230, 200, 460	1, 3	Auto/Non	✓	20 ft.	12-7/8"	18-9/16"	--	--	122	111	99	85	51	6	--	--	--	--	51
294	1-1/2	2" or 3"	230, 200, 460	1, 3	Auto/Non	✓	20 ft.	12-7/8"	18-9/16"	196	181	165	150	136	124	99	67	16	--	--	--	62
295	2	2" or 3"	230, 200, 460	1, 3	Auto/Non	✓	20 ft.	12-7/8"	18-9/16"	214	199	186	173	161	149	124	98	66	23	--	--	75
										5 ft.	10 ft.	15 ft.	20 ft.	25 ft.	30 ft.	35 ft.	40 ft.	45 ft.	50 ft.	55 ft.	60 ft.	
4404	2	4"	230, 460	1, 3	Non	Standard	20 ft.	16-1/8"	26"	300	265	224	184	134	60	--	--	--	--	--	--	33
4405	3	4"	230, 460	1, 3	Non	Standard	20 ft.	12-3/4"	18-9/16"	361	326	284	241	197	134	50	--	--	--	--	--	38
611	1	3" or 4"	230, 200, 460	1, 3	Non	Standard	25 ft.	17-9/16"	29-1/4"	255	190	110	35	--	--	--	--	--	--	--	--	22
621	1-1/2	3" or 4"	230, 200, 460	1, 3	Non	Standard	25 ft.	17-9/16"	29-1/4"	340	277	215	143	72	--	--	--	--	--	--	--	29
631	2	3" or 4"	230, 200, 460, 575	1, 3	Non	Standard	25 ft.	17-9/16"	29-1/4"	385	330	275	220	150	80	--	--	--	--	--	--	35
641	3	3" or 4"	230, 200, 460, 575	1, 3	Non	Standard	25 ft.	17-9/16"	29-1/4"	480	430	380	325	270	208	143	72	--	--	--	--	44
651	5	3" or 4"	230, 200, 460, 575	1, 3	Non	Standard	25 ft.	17-9/16"	29-1/4"	575	533	490	440	390	335	280	220	150	80	--	--	55
661	7-1/2	3" or 4"	230, 200, 460, 575	3	Non	Standard	25 ft.	17-9/16"	29-1/4"	--	600	560	515	475	430	383	330	280	220	150	85	65

\* Single Seal Units

See pages 15-17

## GRINDER PUMPS

Model	HP	Discharge	Volts	Ph	Operation	Std. Cord Length	Width	Height*	Gallons per minute (GPM) @ Height												Shut Off (ft.)	
									10 ft.	30 ft.	50 ft.	70 ft.	90 ft.	110 ft.	130 ft.	150 ft.	170 ft.	190 ft.	210 ft.	220 ft.		240 ft.
810	1	1-1/4"	230	1	Non	20 ft.	15-1/4"	22-3/8"	15.3	14.2	13.2	12.3	11.5	10.5	9.6	8.7	--	--	--	--	--	150
815	2	1-1/4"	230	1	Non	20 ft.	15-1/4"	22-3/8"	15.3	14.2	13.2	12.3	11.5	10.5	9.6	8.7	7.8	6.8	5.7	5.0	4.0	240
									5 ft.	10 ft.	20 ft.	30 ft.	40 ft.	50 ft.	60 ft.	70 ft.	80 ft.	90 ft.	100 ft.	110 ft.	120 ft.	Shut Off (ft.)
803	1/2	1-1/4"	115, 230	1	Auto/Non	15 ft.	10-3/16"	14-3/32"	35	31	22	9	--	--	--	--	--	--	--	--	--	35
805	3/4	1-1/4"	115, 230	1	Auto/Non	15 ft.	10-3/16"	14-3/32"	40	37	29	20	8	--	--	--	--	--	--	--	--	45
807	1	1-1/4"	115, 200, 230	1	Auto/Non	15 ft.	10-3/16"	14-3/32"	45	42	35	27	18	7	--	--	--	--	--	--	--	55
818	1	1-1/4"	115, 200, 230	1	Auto/Non	20 ft.	11-5/8"	18-5/8"	43	42	37	28	16.5	--	--	--	--	--	--	--	--	53
820	2	1-1/4"	200, 230	1	Auto/Non	20 ft.	11-5/8"	18-5/8"	46	46	46	46	46	46	43	36	27	16.7	7	--	--	107
840	2	1-1/4"	230, 200, 460	1, 3	Non	20 ft.	11-21/32"	24-7/32"	45	45	45	44	42	36	30	23	16	10	3	--	--	104
841	2	1-1/4"	230, 200, 460	1, 3	Non	20 ft.	13-3/16"	22"	54	54	54	54	54	52	49	43	36	28	19	11	4	125

\* Single Seal Units

**NOTES:**

- BN/BE Models available packaged with a piggyback variable level float switch.
- A double shaft seal available on 280, 290, 400 & 600 series.

# Technical Specs

See our full line in FM2856

## HAZARDOUS LOCATION

Model	HP	Discharge	Volts	Ph	Operation	Std. Cord Length	Width	Non Auto Height*	Gallons per minute (GPM) @ Height											Shut Off ft.	
									5 ft.	10 ft.	15 ft.	20 ft.	25 ft.	30 ft.	40 ft.	50 ft.	60 ft.	70 ft.	80 ft.		90 ft.
X611	1	3" or 4"	230, 200, 460	1, 3	Non	25 ft.	17-9/16"	33-1/4"	255	190	110	35	--	--	--	--	--	--	--	--	22
X621	1-1/2	3" or 4"	230, 200, 460	1, 3	Non	25 ft.	17-9/16"	33-1/4"	340	277	215	143	72	--	--	--	--	--	--	--	29
X631	2	3" or 4"	230, 200, 460, 575	1, 3	Non	25 ft.	17-9/16"	33-1/4"	385	330	275	220	150	80	--	--	--	--	--	--	35
X641	3	3" or 4"	230, 200, 460, 575	1, 3	Non	25 ft.	17-9/16"	33-1/4"	480	430	380	325	270	208	143	72	--	--	--	--	44
X651	5	3" or 4"	230, 200, 460, 575	1, 3	Non	25 ft.	17-9/16"	33-1/4"	575	533	490	440	390	335	280	220	150	80	--	--	55
X661	7-1/2	3" or 4"	230, 200, 460, 575	3	Non	25 ft.	17-9/16"	33-1/4"	--	600	560	515	475	430	383	330	280	220	150	85	65
									5 ft.	10 ft.	20 ft.	30 ft.	40 ft.	50 ft.	60 ft.	70 ft.	80 ft.	90 ft.	100 ft.	110 ft.	
X840	2	1-1/4"	230, 200, 460	1, 3	Non	20 ft.	11-21/32"	26-1/8"	45	45	45	44	42	36	30	23	16	10	3	--	104
X841	2	1-1/4"	230, 200, 460	1, 3	Non	20 ft.	11-5/8"	25-3/4"	54	54	54	54	54	52	49	43	36	28	19	11	125

# Other Zoeller products . . .

## PACKAGE SYSTEMS

Model	Pumps Available	Volts	Basins Sizes Available	Check Valve Included	Assembled or Preassembled
<b>Preassembled Sewage System</b>					
912	264 & 266	115	18" x 30" & 24" x 24"	Not Included	Preassembled
<b>Preassembled Grinder System</b>					
915	801, 803, 807	115, 230	18" x 30", 24" x 24"	Included	Preassembled
922	820, 840	200/230/1 Ph 460/3 Ph	Various sizes	Included	Preassembled
932	810, 815	230/1 Ph	Drop In Replacements	Included	Preassembled

See our full line in FM2819



## POTABLE SYSTEMS

### Stainless Steel/Cast Iron "A" Series 4" Submersible Pumps

With models rated for small homes, cottages and light water usage demands as well as average residential home and family usage, this series of stainless steel pumps provides economical, quiet operation (see FM2489).

### Cast Iron Shallow Well and Deep Well Jet Pumps

Series of precision jet pumps designed to provide city water pressures for modern rural living (see FM2487).

### Irrigation Pumps

Provide up to 88 GPM (333 LPM) for moving large volumes of water quickly. Heavy duty, rugged construction (see FM2487).

### Centrifugal Pumps

Potable, multi-stage water pumps for high head applications. Designed for booster service, water circulation, cooling systems, laundry equipment and liquid transfer applications (see FM2487).

### City Water Booster Pumps

All-in-one unit, consisting of pump, motor, stainless steel pressure tank and electronic controller (see FM3252).

See our full line in FM2487



For complete product information, visit: [zoellerpumps.com](http://zoellerpumps.com)

# Other Zoeller products . . .

## ACCESSORIES & CONTROLS

See our full line in FM2819

### SmartPak® Plus

This residential alternator system allows you to install two automatic pumps up to 1/2 HP, 115 V, 12 amps, single phase and alternate their use to provide extended pump life. The special design allows for use in humid areas such as basements, and the true alternation allows each pump to be used equally, not timed. The built-in alarm automatically sounds if one of the pumps should fail and calls for the second pump to run during a pump failure (see FM1663).

### Control Panels & Alarms

Zoeller offers a full line of controls and alarms specifically engineered to match our pumps and pump systems. From the most basic indoor alarm to highly advanced custom-built panels, we can meet virtually any specification. Standard simplex and duplex panel features include auto & manual run capabilities, high water alarm and remote monitoring contacts in both indoor and outdoor enclosures. Level sensing floats are included on most panels and alarms as an added value.

Electrical control panels used in simplex and duplex applications that require more than a preset integral or piggy-back float switch can provide. All weather enclosures, built-in alarm systems with remote capability, and manual run override are basic features on most units. Panels with intrinsically safe circuits are available for use with explosion-proof rated pumps in hazardous areas (see FM3459).

### Float Switches

Zoeller has a full line offering of pump and control switches for pump up and down applications. Constructed of PVC/Poly and available in various lengths. Both mechanical and mercury models are available. UL listed (see FM0526 & FM0477).

### Check Valves

Zoeller check valves are quiet, reliable and efficient.

Whether a residential or commercial application, there is a correct Zoeller valve, including silent check valves, ball-check combinations, hi-temperature and much more. Our most popular residential valve #30-0181, has an angled internal flapper to eliminate water hammer, and the body is sonic welded to increase its life. Our cast iron threaded check valve can withstand up to 115' (35 m) of head. (see FM0217).

The Zoeller "Full-Flow" Unicheck features flexible neoprene slip x slip unions with all stainless steel clamps and screws. Saves installation time and is simple to install. No pipe threading required. Features an extra wide flapper hinge to prevent hinge stress. Can be installed in a vertical or horizontal line. Available in cast iron or PVC construction.

### Tri-Check® and The "Combo"

The Zoeller full flow Tri-Check® and "Combo" feature a threaded union that allows the pump to be removed without disrupting discharge piping. This saves time and money and is easy to install. The neoprene gasket and flapper are weighted with stainless steel backing plates and stainless steel rivets and can be installed on either a vertical or horizontal pipe (see FM0217).

### Flood Alert®

The ultimate low water sensing alarm. Stainless steel sensors alert in as little as 1/32" (0.8 mm) of water. Operates on 3 AAA batteries and has low battery alert (see FM1617).

### Qwik-Box Pump Control and Alarm System

A junction connection box designed for easy hookup of pumps and alarm systems used in various applications requiring a connection outside the building or residence. Eliminates the need for junction wiring boxes inside sewage and septic tanks (see FM1420).

### Prewired Conduit and J-Box Assemblies

Prewired Conduit assemblies simplify the electrical portion of any pump job reducing the electrical job to only minutes. Flexible, watertight conduit and junction box assemblies (see FM2080 and FM1597).

### Disconnect and Rail Systems

Complete systems for sewage, effluent and grinder pumps can be field installed or factory installed in concrete, steel or fiberglass basins and tanks. Guide rails direct the pump to and from the base elbow (see FM0787).







## ABOUT THE ZOELLER FAMILY OF WATER SOLUTIONS

Founded in 1939, Zoeller Company is one of the oldest independently-owned professional pump manufacturers in North America. Headquartered in Louisville, Kentucky USA, Zoeller has over 800 employees worldwide and close to 600,000 sq. ft. of manufacturing facilities from our seven operations in North America and Asia.

Zoeller Company has established itself as an innovative leader in pumping equipment and water treatment systems by continuous research and development. The quality of our products is demonstrated by UL, CSA, CE, and NSF listings as well as continued growth throughout the United States, Canada, Mexico, and over 40 other countries around the globe. The company has also expanded to include four brands, which have become the foundation of Zoeller.



The original Zoeller product line now resides in Zoeller Pump Company, which offers a broad range of submersible pumps from fractional to 7-1/2 HP for residential and commercial sump, effluent, dewatering and grinding applications.



Flint & Walling, founded in 1866 in Kendallville, Indiana USA, is the only pump company in the U. S. to manufacture its own motor for jet and centrifugal pumps. This product line specializes in deep well pumps that range from 5 GPM to 1,000 GPM, as well as centrifugal, jet, booster, and submersible pumps up to 7-1/2 HP.



Founded in 1952, Wolf Pump is a manufacturer of submersible turbine pumps located in Abernathy, Texas. Wolf currently produces 4" to 8" pumps with capacities ranging from 35 to 1000 GPM. These pumps are known for their efficiency and durability in demanding water applications including irrigation, municipal water supplies, dewatering applications, dairy production, mining, the oil and gas industries, aquaculture, and more.



Zoeller Engineered Products provides products for storm water removal, sewage pumping stations and hazardous environment applications for residential, commercial and municipal markets. Available from 1/2 BHP to 60 BHP, each pump is customized by design, manufacture and installation according to exact application needs.



FM0532  
0724  
Supersedes  
0424



3649 Cane Run Road • Louisville, KY 40211 • 502-778-2731 • 1-800-928-7867 • [zoellerpumps.com](http://zoellerpumps.com)