

ONKYO

NETWORK STEREO RECEIVER /
NETWORK STEREO AMPLIFIER

TX-8470

Table of contents

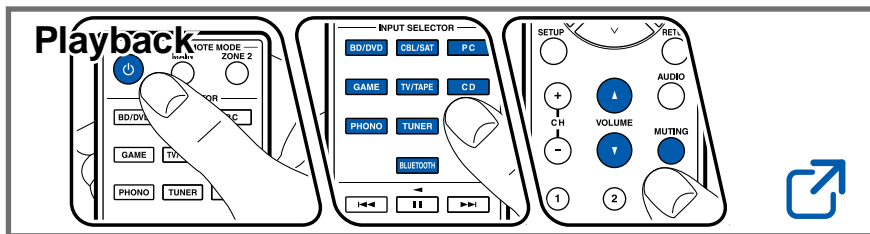
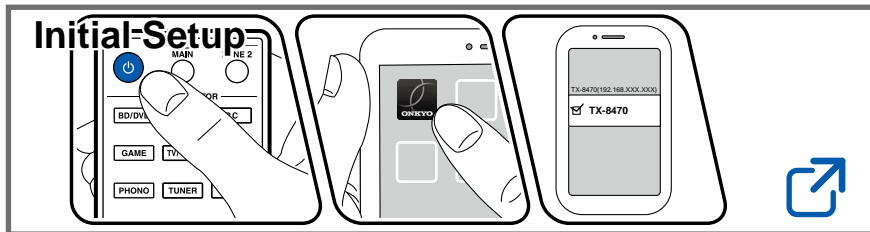
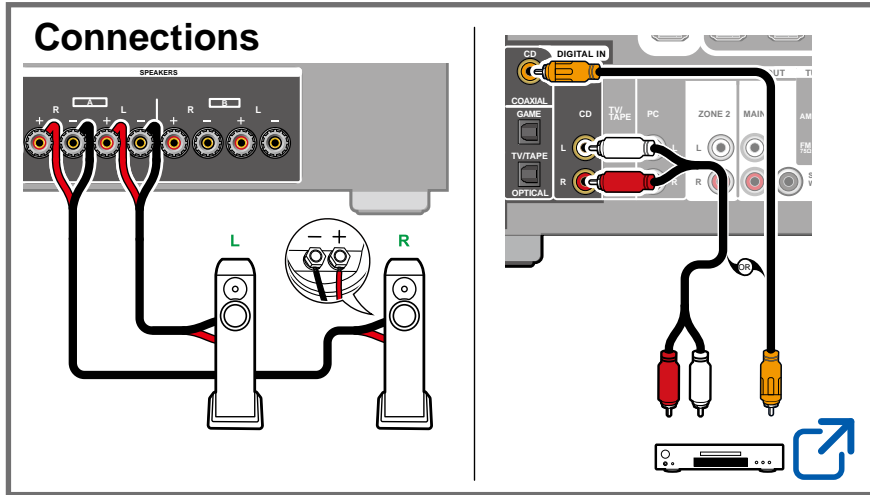

Firmware Update



Troubleshooting



Supplementary Information



Reducing the Power Consumption in Standby State

When the following functions are enabled, the power consumption in standby state increases. To reduce the power consumption in standby state, check each setting and set the functions to "Off".

- HDMI CEC (→[p79](#))
- HDMI Standby Through (→[p79](#))
- Network Standby (→[p80](#))
- Bluetooth Wakeup (→[p80](#))

Detailed contents (Next page)



Before starting the procedure	6	Connecting a Blu-ray/DVD Disc player and Game console	26
Firmware Update	7	Connecting an Audio Component	27
Update Information of the firmware	7		
Checking the Firmware Version of the Unit	7		
Firmware Update Procedure	7		
Part Names	10	Connecting an Integrated Amplifier in a separate room (Multi-zone)	28
Front Panel	10	Connecting Antennas (North American and European models)	29
Display	12	Network Connection	30
Rear Panel	13	Connecting the Power Cord	31
Remote Controller	15		
Inputting Characters	16		
Connections		Initial Setup	
Speakers you can use with this unit and cable connections	18	Before starting the procedure	33
Speaker layout	19	1. Install the app	33
Connecting speakers	20	2. Connect the unit to Wi-Fi	34
Connecting the Subwoofer	21	Set the impedance	34
Connecting a Power Amplifier	22		
Notes regarding connections with HDMI cables	23	Playback	
Connections	23	Basic Operations	36
Connecting the TV	24	Turning the power on	36
To ARC TV	24	Selecting a source to play	36
To Non-ARC TV	24	Adjusting the volume	37
Connecting Playback Devices	26	Adjusting the sound quality and left/right volume balance	37
		Switching speakers	38
		Using the linking function (HDMI CEC)	38
		Switching the display	39



Bluetooth® Playback	40	Playing TIDAL	56
Playing audio from Bluetooth wireless technology enabled devices with this unit	40	Connecting the Sonos System for Playback	57
Transmitting audio from this unit to Bluetooth wireless technology enabled devices	42	Necessary Equipment	57
Listening To the Radio	44	How to Connect This Unit and Sonos Port	57
Listening To the AM/FM Radio	44	Setting Up	57
Using RDS (European models only)	46	Playing Sonos on This Unit	58
Listening To DAB Digital Radio (European models only)	47	Internet Radio	59
Presetting a Radio Station	48	Playing Back	59
Spotify	49	Multi-zone	61
AirPlay®	50	Playing Back (ZONE 2)	62
Basic Operations	50	Playing different audio and video	64
Playing Back on multiple devices (AirPlay2)	51	Displaying Your Favorite Video on TV While Playing Music	64
Amazon Alexa	52	Using MY INPUT	65
Registering this unit with an Amazon account	52	Regarding the settings that can be registered	65
Operating this unit	53	Registering	65
Amazon Music	54	Using the registered settings	65
Registering This Unit with Amazon Music	54	Playing music files saved on a USB storage device	66
Playing Amazon Music using the Onkyo Controller	55	Playing Back	66
Playing Amazon Music using the remote controller	55	USB Storage Device Requirements	67
TIDAL	56	Music Server	68
Registering this unit with TIDAL	56	Music Server notes	68
		Windows Media® Player 12 settings	68
		Playing Back	69



Play Queue	71
Adding Play Queue Information	71
Sort and Delete	71
Playing Back	72

Setup

Setup Menu	74
Menu list	74
1. Audio	78
2. Control	79
3. Network	81
4. Bluetooth	84
5. Works with SONOS	86
6. Firmware Update	87
7. Lock	87
8. Factory Reset	88
Web Setup	89
Menu operations	89

Troubleshooting

Before starting the procedure	91
When the unit is operating erratically	92
Turning off Initial Setup which appears when you turn the power on	93
Troubleshooting	94

Appendix

General Specifications	102
-------------------------------	------------



Before starting the procedure

■ What's in the box

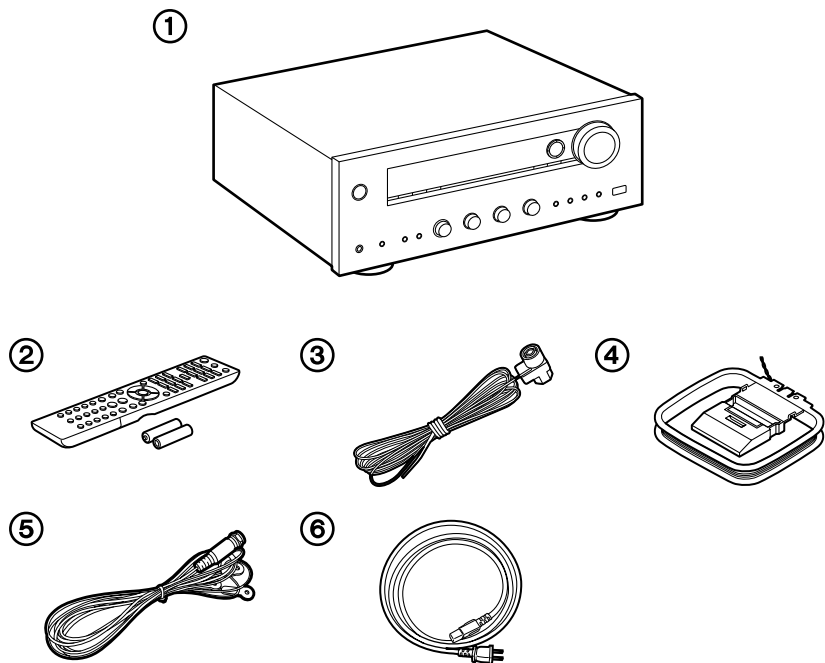

- ① Main unit (1)
- ② Remote controller (RC-903S) (1)
Batteries (AAA/R03) (2) (Some models only)
- ③ Indoor FM antenna (North American models only) (1)
- ④ AM loop antenna (North American models only) (1)
- ⑤ DAB/FM antenna (European models only) (1)
- ⑥ Power cord (1) *Depending on the model, 2 Power Cords are supplied. Use the type of cord suited to your area.
 - Initial Setup Guide (1)

- Safety Information (1)
 - * This is an online user manual. This is not supplied with the product.

■ Note

- Connect speakers with an impedance of 4 Ω to 16 Ω .
- The power cord must be connected only after all other connections are completed.
- We will not accept any responsibility for damage arising from the connection with equipment manufactured by other companies.
- Network services and content that can be used may no longer be available if new functions are added by updating firmware or the service providers terminate their services. Also, available services may differ depending on your area.
- Details on the firmware update will be posted on our website and through other means at a later date.
- The illustrations in this manual use those of North American models unless otherwise mentioned.
- Specifications and appearance are subject to change without prior notice.



Firmware Update

Disclaimer: The program and accompanying online documentation are furnished to you for use at your own risk.

Our company will not be liable and you will have no remedy for damages for any claim of any kind whatsoever concerning your use of the program or the accompanying online documentation, regardless of legal theory, and whether arising in tort or contract.

In no event will our company be liable to you or any third party for any special, indirect, incidental, or consequential damages of any kind, including, but not limited to, compensation, reimbursement or damages on account of the loss of present or prospective profits, loss of data, or for any other reason whatsoever.

Update Information of the firmware

For the latest firmware contents and the firmware version, visit website.

- When this unit is connected to the network, notifications of firmware updates may be displayed. To update the firmware, select "Update Now" with the cursor buttons of the remote controller and press ENTER. The unit automatically enters standby mode after "Completed!" is displayed, and the update is completed.

Checking the Firmware Version of the Unit

To confirm the firmware version of your product, press the SETUP button on the remote controller, and refer to "6. Firmware Update" - "Version" (→[p87](#)).

Firmware Update Procedure

Updating can take about 20 minutes. Furthermore, existing settings are maintained regardless of the method used for update.

Updating the Firmware via Network

- While updating the firmware, do not do the following:
 - Disconnecting and reconnecting cables, USB storage device or headphones, or performing operations on the unit such as turning the power off
 - Accessing this unit from a PC or smartphone using their applications
 - Check that the unit is turned on, and the connection to the Internet is secured.
 - Turn off control devices (PC etc.) connected to the network.
 - Stop an Internet radio, USB storage device, or server content being played.
 - If the multi-zone function is active, turn it off.
 - If "HDMI CEC" is set to "On", set it to "Off".
 - Press the SETUP button. Next, select "2. Control" and press ENTER, then select "HDMI CEC" and select "Off".
- * The descriptions may differ from the actual on-screen displays, however, operations and functions are the same.

Update

1. Press SETUP.
The Setup menu is displayed on the TV screen.
2. Select "6. Firmware Update" - "Update via NET" with the cursor buttons in order and press ENTER.
 - If "6. Firmware Update" is not available for selection, wait until the system has started.
 - You will not be able to select "Update via NET" if there is nothing to update.
3. With "Update" selected, press ENTER to start the update.
 - During the update, the TV screen may go black depending on the updated program. In that case, check the progress on the display of the unit. The TV screen will remain black until the update is complete and the power is turned on again.
 - "Completed!" is displayed when the update is complete.



- Press \odot ON/STANDBY on the main unit to turn the unit into standby mode.
The process is completed, and your firmware is updated to the latest version.
 - Do not use \odot on the remote controller.

If an Error Message is Displayed

If an error occurs, "*-*-* Error!" is displayed on the display of the unit. ("*" represents an alphanumeric character.) Refer to the following descriptions and check.

Error Code

- *-01, *-10:
Ethernet cable not found. Connect the Ethernet cable properly.
- *-02, *-03, *-04, *-05, *-06, *-11, *-13, *-14, *-16, *-17, *-18, *-20, *-21:
Internet connection error. Check the following:
 - Whether the router is turned on
 - Whether this unit and the router are connected via the network
 Unplug and plug the power cords of this unit and the router. This may solve the problem. If you are still unable to connect to the Internet, the DNS server or proxy server may be temporarily down. Check the server operation status with your Internet service provider.
- Others:
After removing the power plug once, insert it to the outlet, and then start the operation from the beginning.

Updating via USB

- While updating the firmware, do not do the following:
 - Disconnecting and reconnecting cables, USB storage device or headphones, or performing operations on the unit such as turning the power off
 - Accessing this unit from a PC or smartphone using their applications
- Prepare a 1 GB or larger USB storage device. The format of USB storage devices supports FAT16 or FAT32 file system format.
 - Media inserted into a USB card reader may not be used for this function.
 - USB storage devices equipped with the security function are not supported.
 - USB hubs and USB devices equipped with the hub function are not supported. Do not connect these devices to the unit.
- Delete any data stored on the USB storage device.
- Turn off control devices (PC etc.) connected to the network.
- Stop an Internet radio, USB storage device, or server content being played.
- If the multi-zone function is active, turn it off.
- If "HDMI CEC" is set to "On", set it to "Off".
 - Press the SETUP button. Next, select "2. Control" and press ENTER, then select "HDMI CEC" and select "Off".
- * Depending on the USB storage device or its content, long time may be required for loading, the content may not be loaded correctly, or power may not be supplied correctly.
- * Our company will not be liable whatsoever for any loss or damage of data, or storage failure arising from the use of the USB storage device. Please note this in advance.
- * The descriptions may differ from the actual on-screen displays, however, operations and functions are the same.

Update

- Connect the USB storage device to your PC.
- Download the firmware file from the our company's website to your PC and unzip.
Firmware files are named as below.
ONKAVR****_R***.zip
Unzip the file on your PC. The number of unzipped files and folders varies depending on the model.
- Copy all unzipped files and folders to the root folder of the USB storage device.
 - Make sure to copy the unzipped files.



4. Connect the USB storage device to the USB port of this unit.
 - If an AC adapter is supplied with the USB storage device, connect the AC adapter, and use it with a household outlet.
 - If the USB storage device has been partitioned, each section will be treated as an independent device.
5. Press SETUP.
The Setup menu is displayed on the TV screen.
6. Select "6. Firmware Update" - "Update via USB" with the cursor buttons in order and press ENTER.
 - If "6. Firmware Update" is not available for selection, wait until the system has started.
 - You will not be able to select "Update via USB" if there is nothing to update.
7. Press ENTER with "Update" selected, and start update.
 - During the update, the TV screen may go black depending on the updated program. In that case, check the progress on the display of the unit. The TV screen will remain black until the update is complete and the power is turned on again.
 - During the update, do not turn the power off, or disconnect or reconnect the USB storage device.
 - "Completed!" is displayed when updating is completed.
8. Disconnect the USB storage device from the unit.
9. Press \odot ON/STANDBY on the main unit to turn the unit into standby mode.
The process is completed, and your firmware is updated to the latest version.
 - Do not use \odot on the remote controller.

firmware file.

- Others:
After removing the power plug once, insert it to the outlet, and then start the operation from the beginning.

If an Error Message is Displayed

If an error occurs, "*-*-* Error!" is displayed on the display of the unit. ("*" represents an alphanumeric character.) Refer to the following descriptions and check.

Error Code

- *-01, *-10:
The USB storage device cannot be recognized. Check if the USB storage device or USB cable is securely inserted to the USB port of the unit. Connect the USB storage device to an external power source if it has its own power supply.
- *-05, *-13, *-20, *-21:
The firmware file is not present in the root folder of the USB storage device, or the firmware file is for another model. Retry from the download of the



Part Names

Front Panel

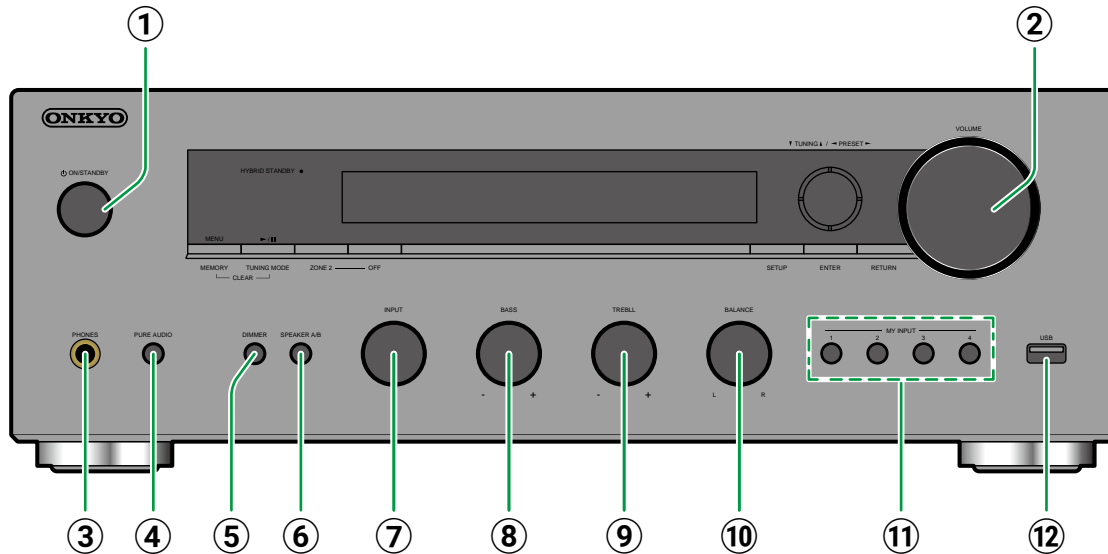

- ⑤ **DIMMER button** (North American, Middle East, Australian and Asian models): Switches the brightness of the display with three levels. It cannot be turned off completely.
- RT/PTY button** (European models): Used when receiving stations transmitting text information.
- ⑥ **SPEAKER A/B buttons**: Select the terminals to output audio from between SPEAKERS A/B.
- ⑦ **INPUT dial**: Switches the input to be played.
- ⑧ **BASS dial**: Adjusts the bass.
- ⑨ **TREBLE dial**: Adjusts the treble.
- ⑩ **BALANCE dial**: Adjusts the balance of the sounds output from the left and right speakers.
- ⑪ **MY INPUT buttons**: You can register settings conditions such as the current input selection or listening mode, and then recall them. (→p65)
- ⑫ **USB port**: Connect a USB storage device to play music files. You can also supply power (5 V/1 A) to USB devices with a USB cable.

- ① **ON/STANDBY button**
- ② **VOLUME dial**
- ③ **PHONES jack**: Connect headphones with a standard plug (ø1/4"/6.3 mm).

- ④ **PURE AUDIO button/LED indicator**: Switches Pure Audio mode, which provides purer sound, on or off. The LED indicator lights when you switch it on, the display turns off and the "Bass" and "Treble" settings are disabled.
 - The Pure Audio mode is canceled when the multi-zone function is turned on.



Front Panel

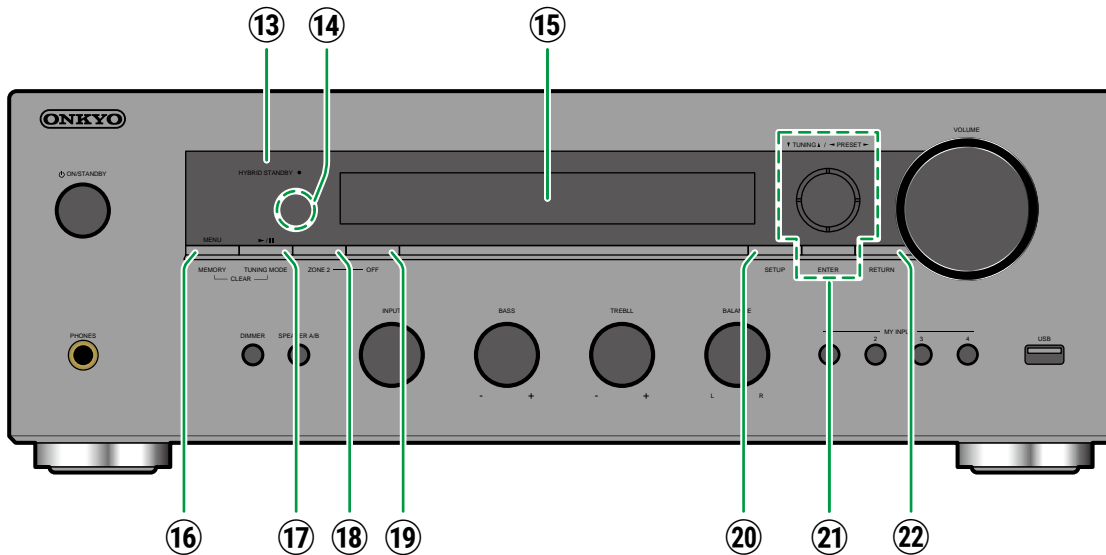

⑬ **HYBRID STANDBY indicator:** Lights up when any of the following functions is working or enabled in standby state of this unit. When this indicator is lighting, the power consumption in standby state increases, however, the increase in power consumption is minimized by entering the HYBRID STANDBY mode where only the

- essential circuits operate
- HDMI CEC (→p79)
 - HDMI Standby Through (→p79)
 - Network Standby (→p80)
 - Bluetooth Wakeup (→p80)

- ⑭ **Remote control sensor:** Receives signals from the remote controller.
 - The reception range of the remote controller is within a distance of approx. 16/5 m, and an angle of 20° in vertical direction and 30° to right and left.
- ⑮ **Display** (→p12)
- ⑯ **MENU button:** Used to display the menu.
MEMORY button (North American and European models): Used to register AM/FM/DAB radio stations.
- ⑰ **Play (▶)/Pause (⏸) button:** Used for play operations when playing Music Server or USB.
TUNING MODE button (North American and European models) : Switches tuning to an AM/FM station between automatic tuning and manual tuning, and allows you to select the order for displaying DAB stations.
- ⑱ **ZONE 2 button:** Controls the multi-zone function. (→p61)
- ⑲ **OFF button:** Switches the multi-zone function off.
- ⑳ **SETUP button:** You can display advanced setting items on the TV and the display to have a more enjoyable experience with this unit. (→p74)
- ㉑ **Cursor buttons (▲/▼/◀/▶) and ENTER button:** Select an item with the cursors, and press ENTER to confirm your selection. Use them to tune to stations when using TUNER (→p44)
- ㉒ **RETURN button:** Returns the display to the previous state while setting.



Display

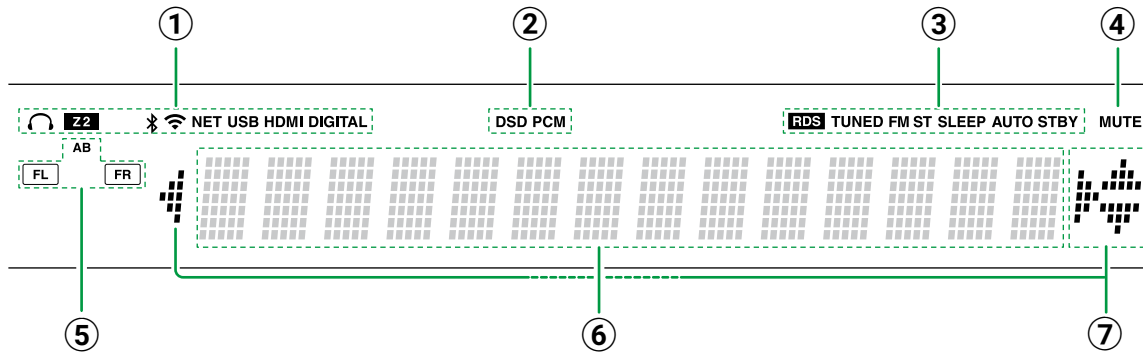

① Lights in the following conditions.

🎧: Headphones are connected.

Z2: ZONE 2 is on.

📶: Connected by Bluetooth.

📶: Connected by Wi-Fi.

NET: Lights when connected to the network with the "NET" input selector. It will blink if incorrectly connected to the network.

USB: Lights when the "NET" input selector is selected, a USB device is connected and the USB input is selected. It will blink if the USB device is not properly connected.

HDMI: HDMI signals are input and the HDMI input is selected.

DIGITAL: Digital signals are input and the digital

input is selected.

② Lights according to the type of input digital audio signal.

③ Lights in the following conditions.

RDS (European models): Receiving RDS broadcasting.

TUNED: Receiving DAB (European models)/AM (North American models)/FM (North American and European models) radio.

FM ST: Receiving FM stereo.

SLEEP: Sleep timer is set.

AUTO STBY: Auto Standby is set. (→p80)

④ **MUTE:** Blinks when muting is on.

⑤ **Speaker/Channel display:** Displays the speaker channels being output.

A: When audio is being output from the SPEAKERS A terminals

B: When audio is being output from the SPEAKERS B terminals

AB: When audio is being output from both the SPEAKERS A and SPEAKERS B terminals

⑥ Displays various information of the input signals.

⑦ **Cursors** (Λ / ∨ / < / >): These may light when performing operations while "NET" is selected with the input selector. Λ / ∨ light when there are multiple folders or files that are available to be selected. < / > light when text information does not fit with the range provided by "⑥".



Rear Panel

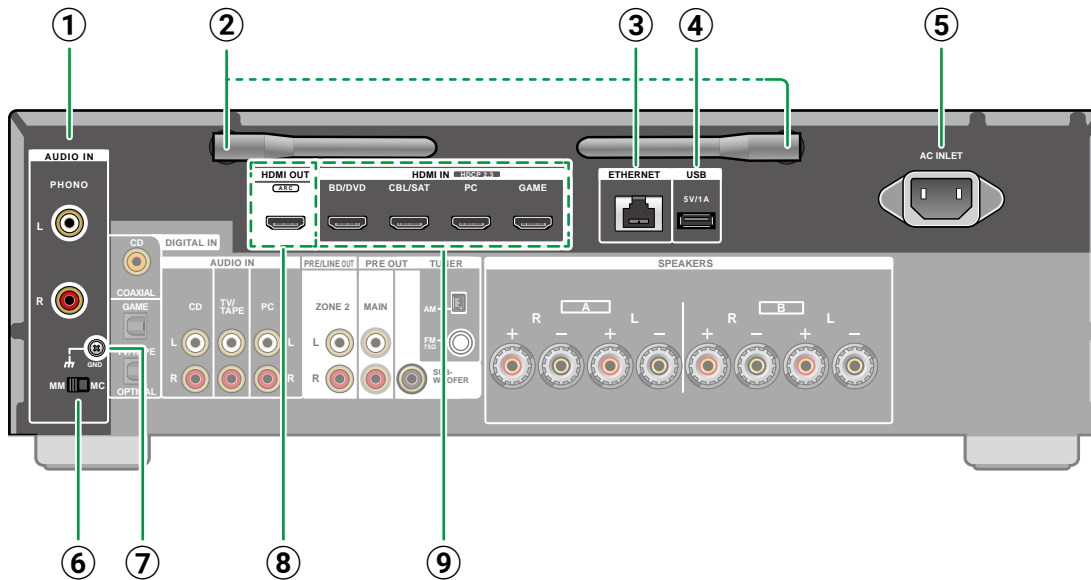

① **PHONO jack**: Use an analog audio cable to connect either an MM or MC type cartridge turntable.

② **Wireless antenna**: Used for Wi-Fi connection or when using a Bluetooth enabled device. Adjust the angles according to the connection status.

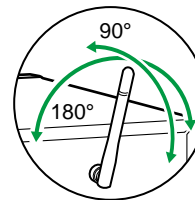

- ③ **ETHERNET port**: Connect to the network with an Ethernet cable.
- ④ **USB port**: Connect a USB storage device to play music files (→p66). You can also supply power (5 V/1 A) to USB devices with a USB cable.
- ⑤ **AC INLET**: Connect the supplied power cord.
- ⑥ **MM/MC switch**: Switch to suit the turntable cartridge type (MM or MC).
- ⑦ **GND terminal**: Connect the ground wire of the turntable.
- ⑧ **HDMI OUT jacks**: Transmit video signals and audio signals with an HDMI cable connected to a monitor such as a TV or projector.
- ⑨ **HDMI IN jacks**: Transmit video signals and audio signals with an HDMI cable connected to an AV component.



Rear Panel

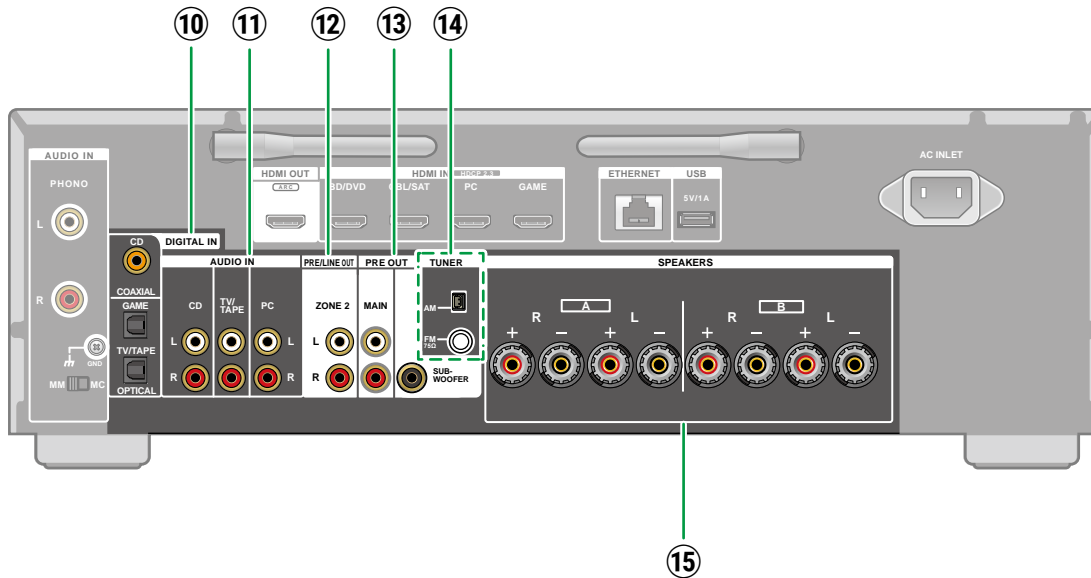

- 10 DIGITAL IN OPTICAL/COAXIAL jacks:** Input TV or AV component digital audio signals with a digital optical cable or digital coaxial cable.
- 11 AUDIO IN jacks:** Input AV component audio signals with an analog audio cable.
*For models that do not have a tuner, the “PC” jack is changed to a “TUNER” jack.

- 12 ZONE 2 PRE/LINE OUT jacks:** Output audio signals with an analog audio cable connected to an integrated amplifier in a separate room (ZONE 2).
- 13 MAIN PRE OUT jacks:** Connect a power amplifier. (→p22)
SUBWOOFER PRE OUT jacks: Connect a powered subwoofer with a subwoofer cable.

- 14 TUNER AM/FM terminal** (North American models): Connect the supplied antennas.

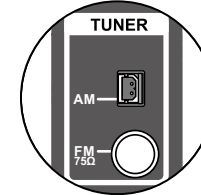

- TUNER DAB/FM terminal** (European models): Connect the supplied antennas.

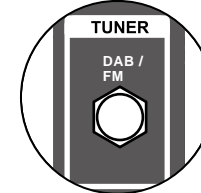

- 15 SPEAKERS terminals:** Connect speakers with speaker cables. (North American and Japanese models are banana plug ready. Use plugs with a diameter of 4 mm.)
Connection with spade lugs is not supported.



Remote Controller

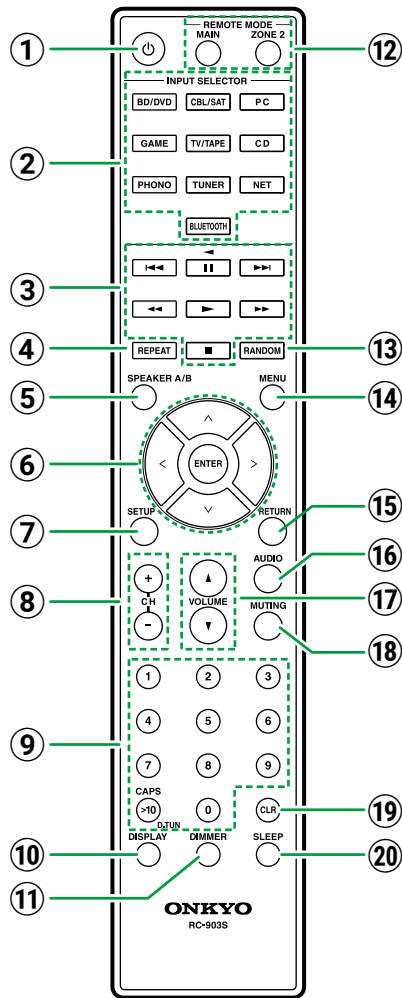

- ① **ON/STANDBY button**
- ② **INPUT SELECTOR buttons:** Switches the input to be played.
- ③ **Play buttons:** Used for playback operations for the Music Server (→ [p68](#)) or USB device (→ [p66](#)).
- ④ **REPEAT button :** Used for repeat play operations when playing Music Server or USB. Each time you press the button, the mode switches from (1-track repeat) to (folder repeat).
- ⑤ **SPEAKER A/B button:** Select the terminals to output audio from between SPEAKERS A/B.
- ⑥ **Cursor buttons and ENTER button:** Select an item with the cursors, and press ENTER to confirm your selection. Pressing </> LEFT/RIGHT button allows you to switch the screen when a music folder list or file list is not displayed on one screen on the TV.
- ⑦ **SETUP button:** Displays advanced setting items on the TV or the display to have a more enjoyable experience with this unit. (→ [p74](#))
- ⑧ **CH (+/-) buttons:** Used to select DAB (European models)/AM (North American models)/FM (North American and European models) radio stations.
- ⑨ **Numbered buttons**
- ⑩ **DISPLAY button:** Switches the information on the display. You can display information such as the input source, volume, and input format when pressed repeatedly during play.
- ⑪ **DIMMER button:** Switches the brightness of the display with three levels. It cannot be turned off completely.

- ⑫ **REMOTE MODE MAIN/ZONE 2 buttons:** Controls the multi-zone function (→ [p61](#)).
- ⑬ **RANDOM button:** Used for random play operations when playing Music Server or USB. Random () turns on or off each time you press the button .
- ⑭ **MENU button:** Used to display the menu.
- ⑮ **RETURN button:** Returns the display to the previous state while setting.
- ⑯ **AUDIO button:** Enables you to make adjustments such as the strength of the bass and treble and the balance between left and right. (→ [p37](#))
- ⑰ **VOLUME buttons**
- ⑱ **MUTING button:** Temporarily mutes audio. Press the button again to cancel muting.
- ⑲ **CLR button:** Deletes all characters you have entered when entering text on the TV screen.
- ⑳ **SLEEP button:** You can allow the unit to enter standby automatically when the specified time has elapsed. Select the time from "30 min", "60 min", "90 min" and "Off". When you do not want to turn the unit to standby automatically, select "Off".



Inputting Characters

You can use the keyboard displayed on the TV to enter the password in Wi-Fi Setup (→p81).

1. Select a character or symbol with the cursors \wedge / \vee / \langle / \rangle UP/DOWN/LEFT/RIGHT on the remote controller and press the ENTER button.
2. When saving characters after input, select "OK" and press the ENTER button.

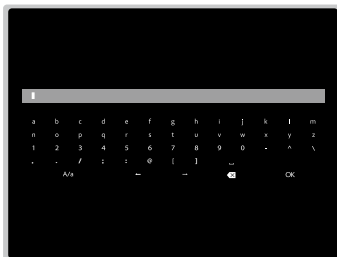

- Select "A/a" to switch between upper and lower cases.
- To enter a space, select "␣".
- To delete a character on the left of the cursor, select "⌫".
- To delete all the input characters, press the CLR button on the remote control.

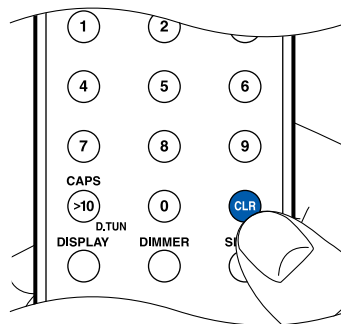
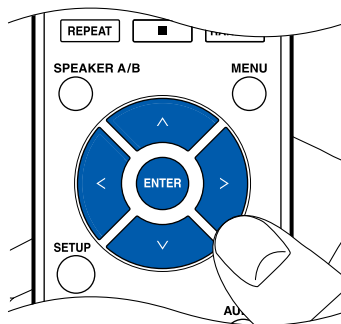

Connections

(Before starting the procedure)
Speakers you can use with this unit and cable connections

18

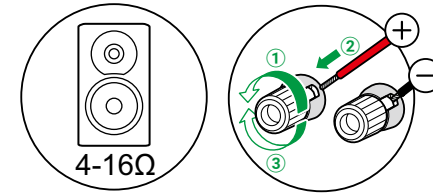

Speaker layout	19
Connecting speakers	20
Connecting the Subwoofer	21
Connecting a Power Amplifier	22
Notes regarding connections with HDMI cables	23
Connecting the TV	24
Connecting Playback Devices	26
Connecting an Integrated Amplifier in a separate room (Multi-zone)	28
Connecting Antennas (North American and European models)	29
Network Connection	30
Connecting the Power Cord	31



Speakers you can use with this unit and cable connections

■ Speakers you can use with this unit

This unit supports speakers with 4 Ω to 16 Ω impedance. For speaker impedance, check the speaker instruction manual.

■ (Note) Speaker Impedance

If any of the connected speakers have 4 Ω or more to less than 6 Ω impedance, you have to set the impedance. Press the SETUP button on the remote controller, then set "1. Audio" - "Speaker Impedance" (→ [p78](#)) to "4ohms". When connecting two speaker systems for simultaneous output from both systems, connect speakers with 8 Ω to 16 Ω impedance.

■ Connect the Speaker Cables

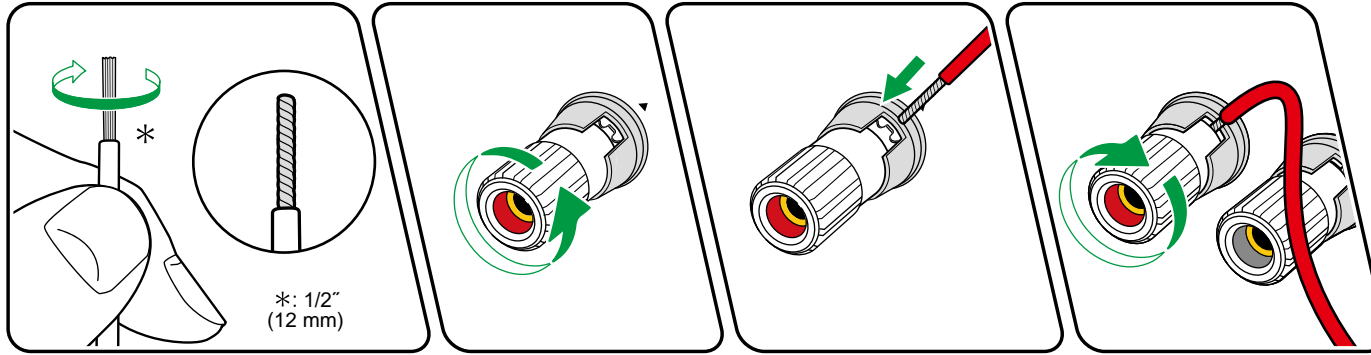

Make correct connection between the unit's jacks and speaker's jacks (+ side to + side, and - side to - side) for each channel. If the connection is wrong, a bass sound will not be reproduced properly due to reverse phase. Twist the wires exposed from the tip of the speaker cable so that the wires do not stick out of the speaker terminal when connecting. If the exposed wires touch the rear panel, or the + side and - side wires touch each other, a malfunction may occur.

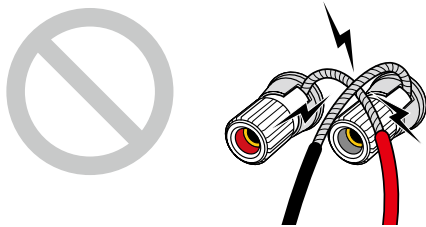

Speaker layout

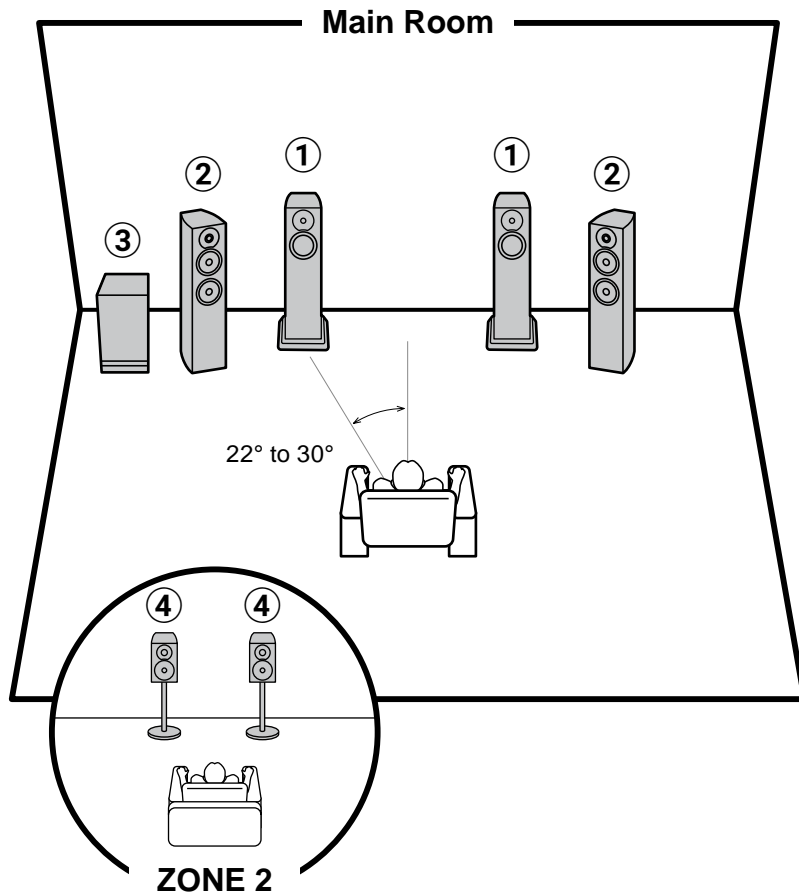

① SPEAKER A

Speakers to be connected to the SPEAKERS A terminals. Install in the main room (where this unit is located).

② SPEAKER B

You can connect another speaker system to this unit. Connect these speakers to the SPEAKERS B terminals.

③ Powered Subwoofer

The powered subwoofer reproduces bass sounds and enriches the sound field. ([→p21](#))

④ ZONE 2 Speakers

The speaker system set up in a separate room (ZONE 2). This enables you to play the same source in the main room and the separate at the same time, or to play separate sources. Note that to use ZONE 2 Speakers you will require a separately available amplifier. ([→p28](#))

Connecting speakers ([→p20](#))



Connecting speakers

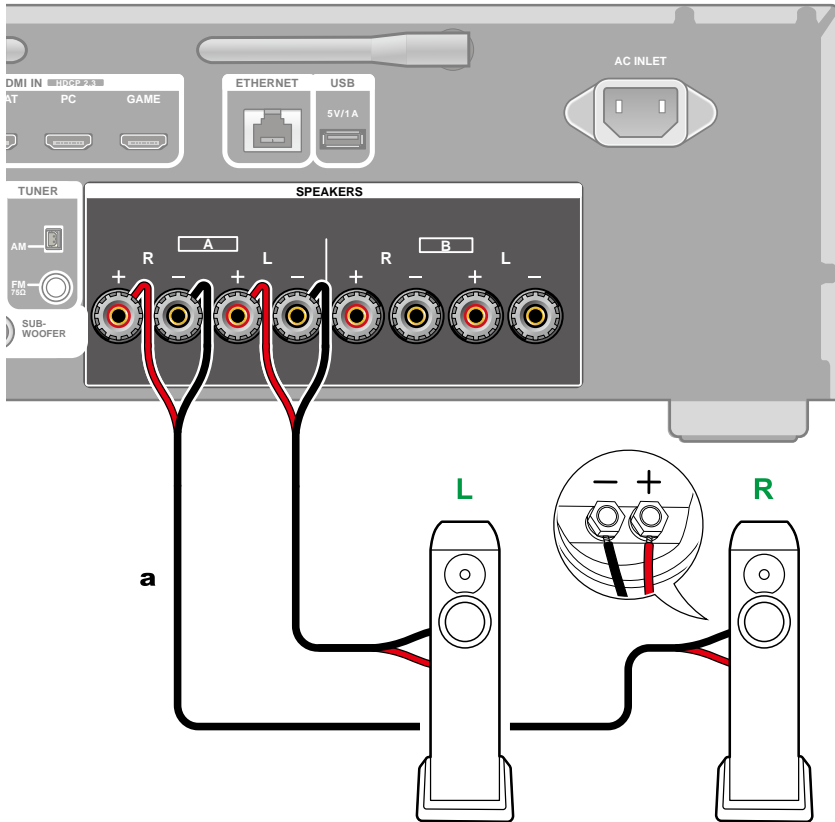

a Speaker cable

Connect the speakers to the unit with speaker cable.

- You can connect two sets of speakers to this unit. You can select which set to listen to when enjoying music. You can also choose to listen to sounds from both sets.

Press SPEAKER A/B on the remote controller or the main unit to switch the audio output. The selection changes in the order SPEAKER A, SPEAKER B, SPEAKER A+B with each press. (→[p38](#))

Note

When outputting audio simultaneously from 2 speaker systems

Connect speakers with 8 Ω to 16 Ω impedance.

When switching audio output to one of either SPEAKER A or B

Connect speakers with 4 Ω to 16 Ω impedance.



Connecting the Subwoofer

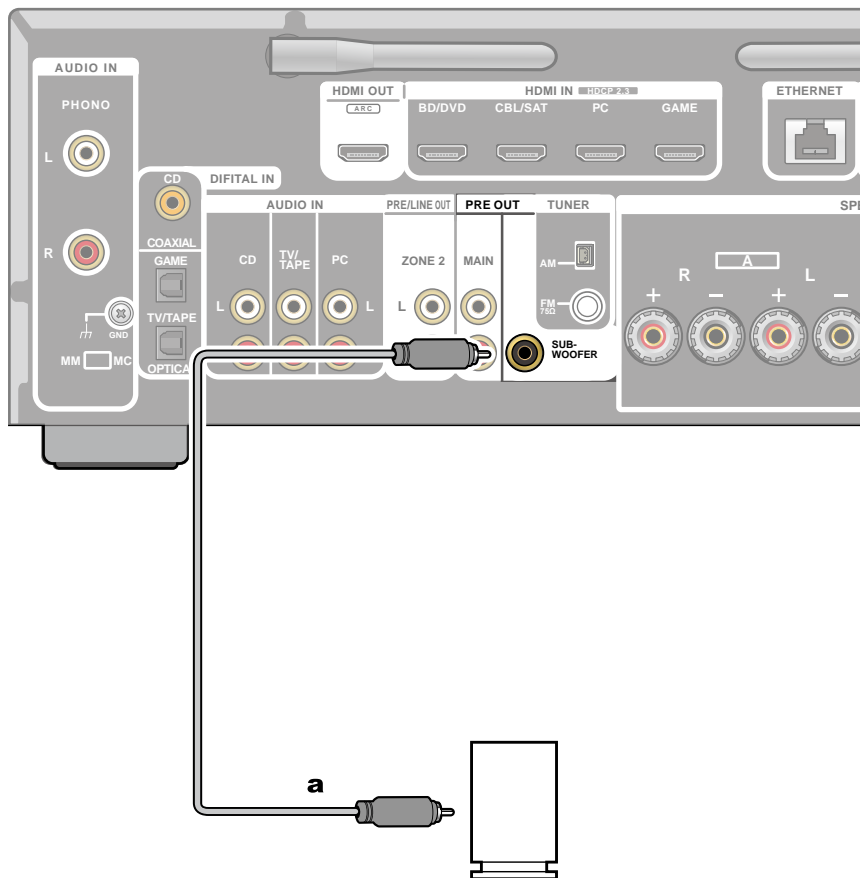

Connect a powered subwoofer with this unit using a subwoofer cable.

a Subwoofer cable



Connecting a Power Amplifier

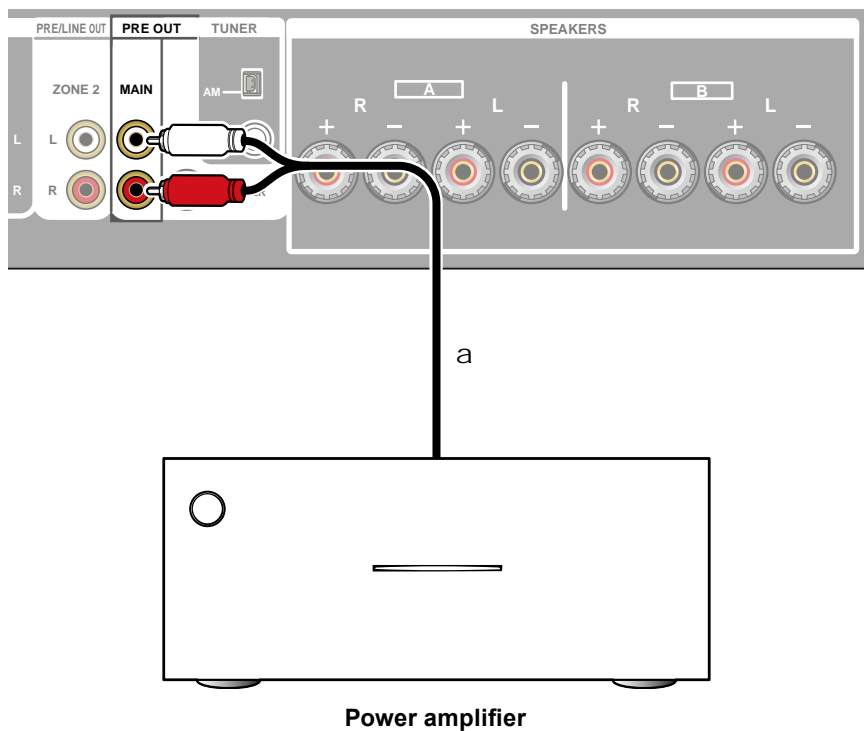

You can connect a power amplifier to the unit and use the unit as a pre-amplifier. This enables you to playback at high volumes that the unit by itself cannot produce. Connect the speakers to the power amplifier. For details, refer to the power amplifier's instruction manual.

- Use the MAIN PRE OUT terminals as shown in the illustration at left.

a Analog audio cable



Notes regarding connections with HDMI cables

HDMI (High-Definition Multimedia Interface) is a digital interface standard for connecting TVs, projectors, Blu-ray Disc players, game consoles, and other video components. With HDMI, a single cable can carry control signals, digital video, and digital audio.

Connections

Push HDMI cables straight in and all the way. You can damage the terminals if you try to insert at an angle.

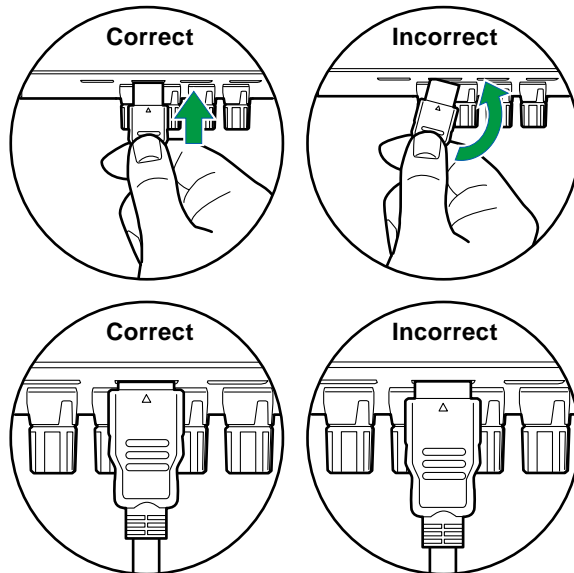

- Hold the terminal housing on the HDMI cable when unplugging. Pulling on the cable may lead to damaged cabling.

■ (Note) Placement of cables

Putting a load on HDMI cables can lead to poor operational performance. Place the cables so there is no load put on them.

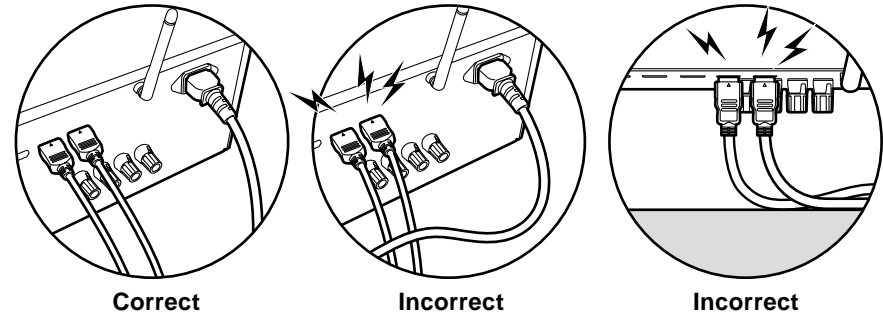

- When 4K high-quality video (4K 120 Hz, etc.) or 8K high-quality video (8K 60 Hz, etc.) is to be played, use ULTRA High Speed HDMI Cable that has the "ULTRA HIGH SPEED" label attached to the packaging.



Connecting the TV

By connecting a TV to this unit, you can show the video from AV devices connected to this unit on the TV and also play the sound from the TV through this unit.

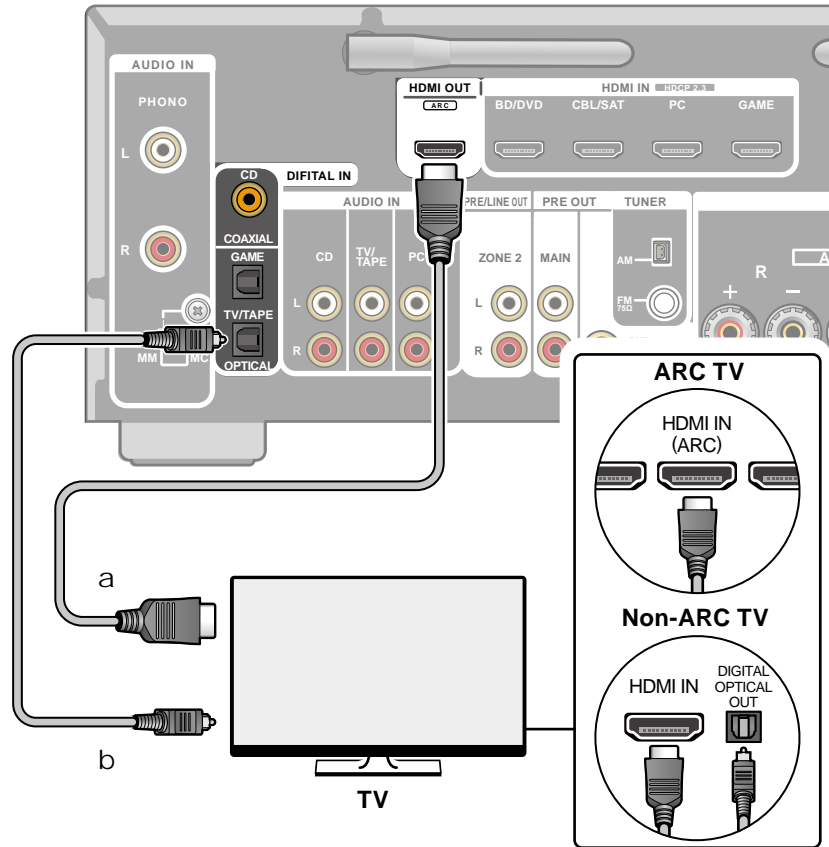

a HDMI cable, b Digital optical cable

To ARC TV

If the TV supports the ARC (Audio Return Channel) function(*), use only the HDMI cable to connect with the TV. Use the ARC-compatible HDMI IN jack of the TV for connection.

To Non-ARC TV

If the TV does not support the ARC (Audio Return Channel) function(*), connect an HDMI cable and digital optical cable. If the TV does not have a DIGITAL OPTICAL OUT jack, you can use an analog audio cable to connect with the AUDIO IN TV/TAPE jack.

- If you use a cable set-top box, etc. connected to the input jack of this unit to watch TV (without using a TV's built-in tuner), connection with a digital optical cable or analog audio cable is not required.



Setup

- When not using the ARC function, press the SETUP button on the remote controller, then set "2. Control" - "Audio Return Channel" (→p80) to "Off".

(*)The ARC function transmit the audio signals of the TV via an HDMI cable, and plays the audio of the TV on this unit. To check if the TV supports the ARC function, refer to the instruction manual of the TV, etc.

ARC compatible audio format (→p104)



- Use an HDMI cable that supports 4K or 8K high-quality video when these are to be played.
- Be sure to insert the HDMI cable all the way in.



Connecting Playback Devices

Connecting a Blu-ray/DVD Disc player and Game console

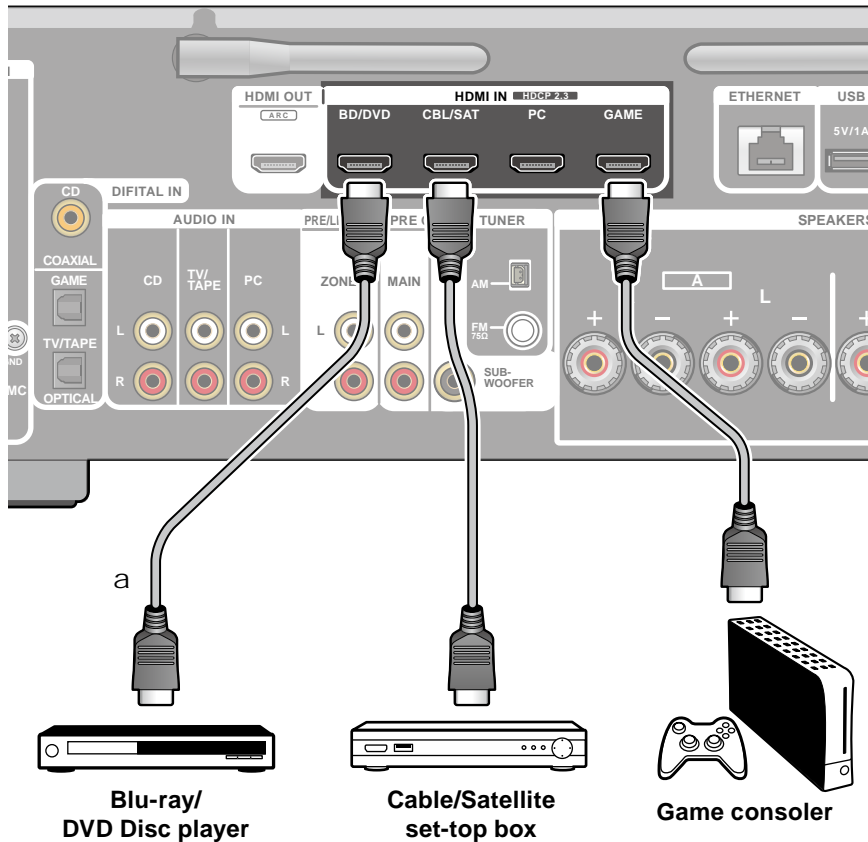

a HDMI cable

This is a connection example of an AV component equipped with an HDMI jack. When connecting with an AV component that conforms to the CEC (Consumer Electronics Control) standard, you can use the HDMI CEC function (*) that enables linking with input selectors, etc. and the HDMI Standby Through function that can transmit video and audio signals of the AV component to the TV even if this unit is in standby mode.

(*) The HDMI CEC function: This function enables various linking operations with CEC-compliant devices, such as switching input selectors interlocking with a CEC-compliant player, switching audio output between TV and this unit or adjusting the volume using the remote controller of a CEC-compliant TV, and automatically switching this unit to standby when the TV is turned off.

- Use an HDMI cable that supports 4K or 8K high-quality video when these are to be played.
- Be sure to insert the HDMI cable all the way in.



Connecting an Audio Component

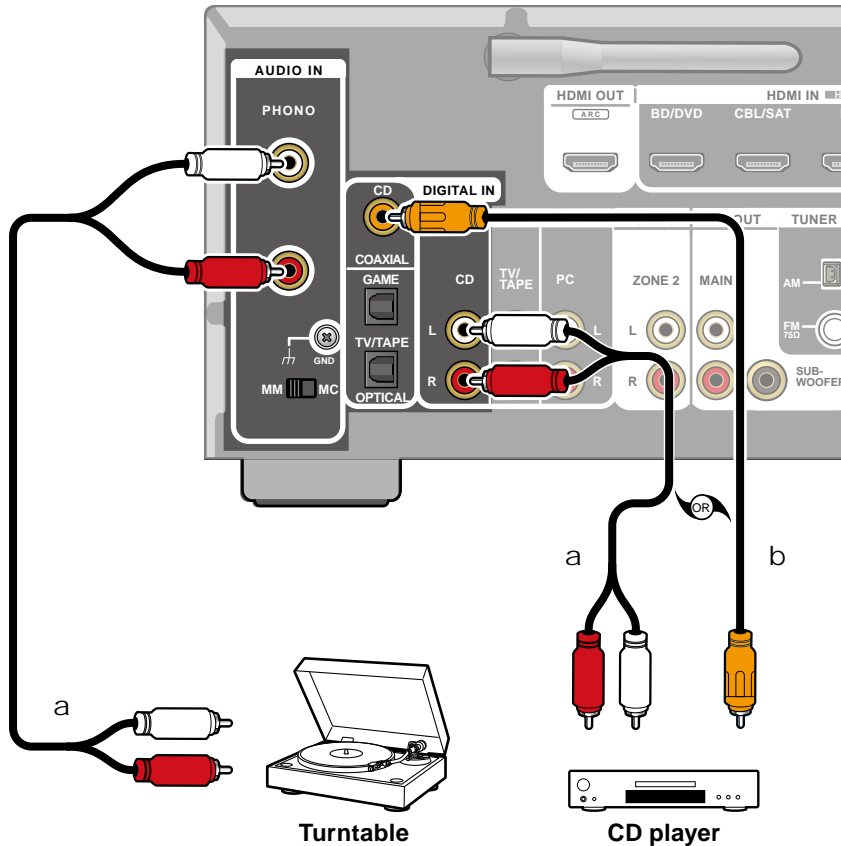

This is a connection example of an audio component. Connect a CD player using an analog audio cable. You can also connect a turntable that has an MM-type or MC type cartridge to the PHONO jack.

- If the turntable has a built-in phono equalizer, connect it to any of the AUDIO IN jacks other than the PHONO jack.
- Switch the MM/MC switch to suit the turntable cartridge type (MM or MC).

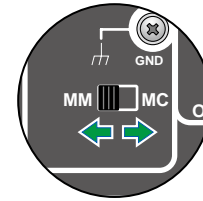

- If the turntable has a ground wire, connect it to the GND terminal of this unit.

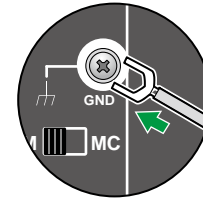

a Analog audio cable, b Digital coaxial cable



Connecting an Integrated Amplifier in a separate room (Multi-zone)

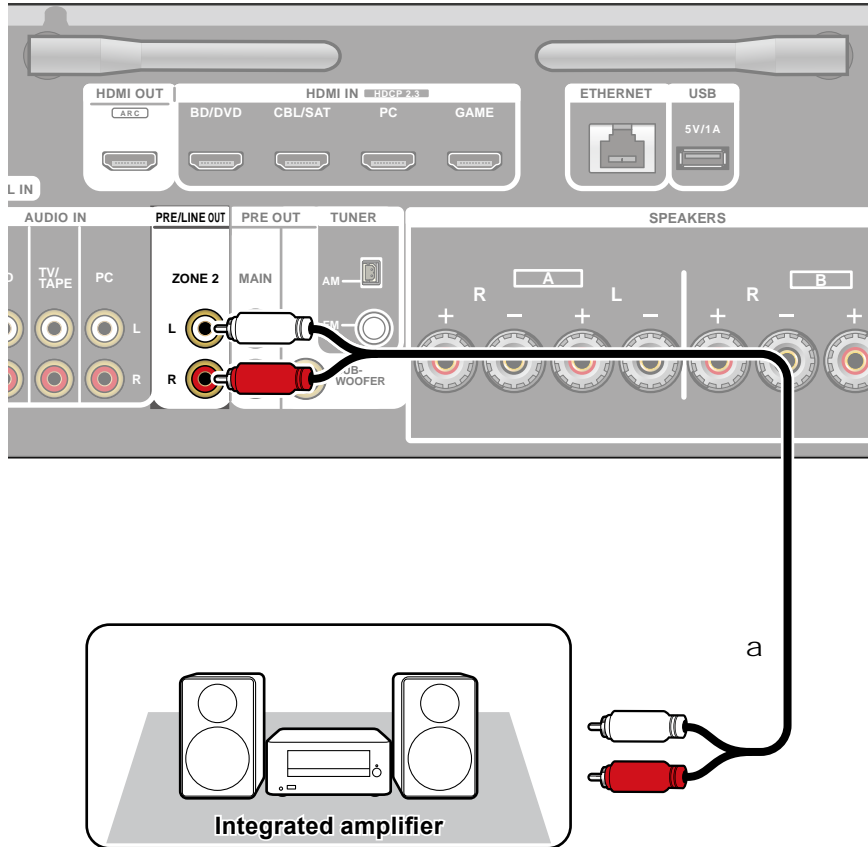

a Analog audio cable

You can enjoy 2 ch audio in the separate room (ZONE 2) while performing playback in the main room (where this unit is located). Use an analog audio cable to connect the ZONE 2 PRE/LINE OUT jacks on this unit to the input jack on an integrated amplifier in the separate room.

- To output audio from an externally connected AV component to ZONE 2, use an analog audio cable for connection. Note that ZONE 2 output is not possible with the connection using an HDMI cable, digital coaxial cable, or digital optical cable.



Setup

- When connecting an integrated amplifier that does not have a volume control, set "1. Audio" - "Zone 2 Output Level" (→p78) to "Variable" (Default Value: Fixed) on the Setup menu. If you do not set this, the volume output will be very loud and there is a danger of damage to the integrated amplifier, speakers, etc. When connecting an integrated amplifier that has a volume control, leave this as "Fixed".

Multi-zone (→p61)

Playing Back (ZONE 2) (→p62)



Connecting Antennas (North American and European models)

Connect the antenna to this unit, and set up the antenna at the best position for listening while receiving radio signals.

North American models

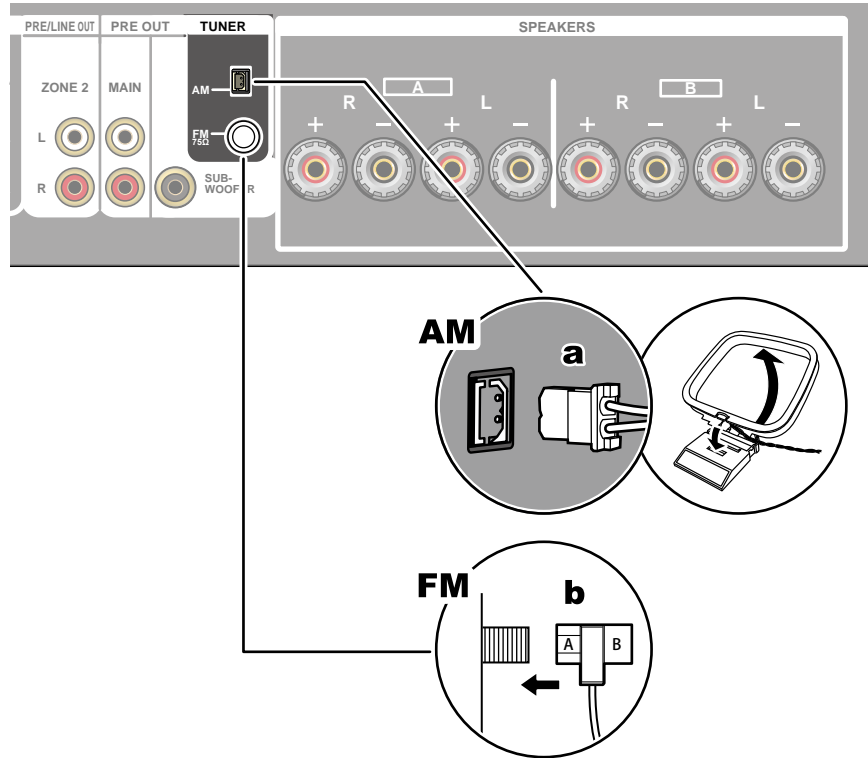

- Attach the indoor FM antenna to the wall using push pins or adhesive tape.

a AM loop antenna, b Indoor FM antenna

European models

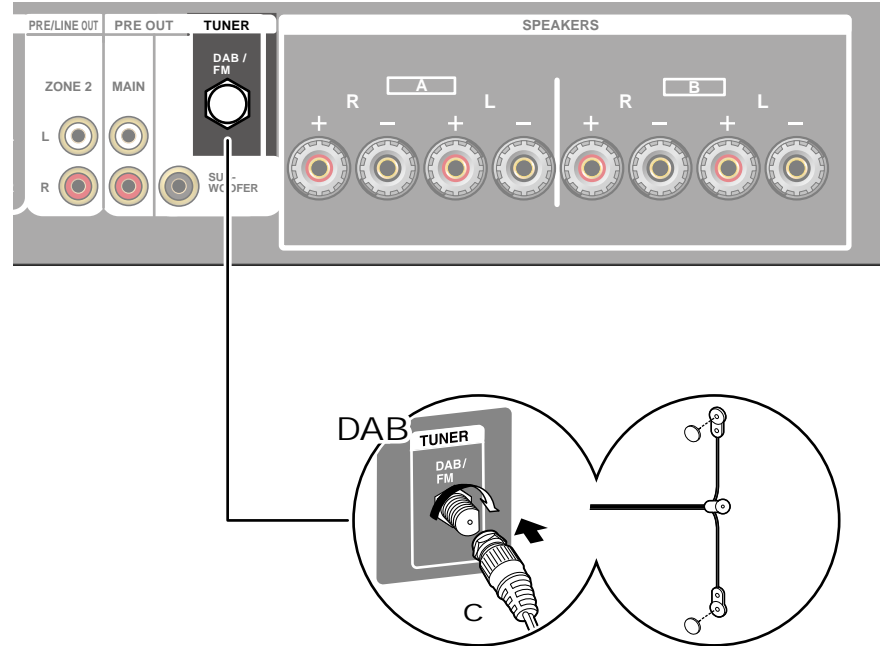

c DAB/FM antenna



Network Connection

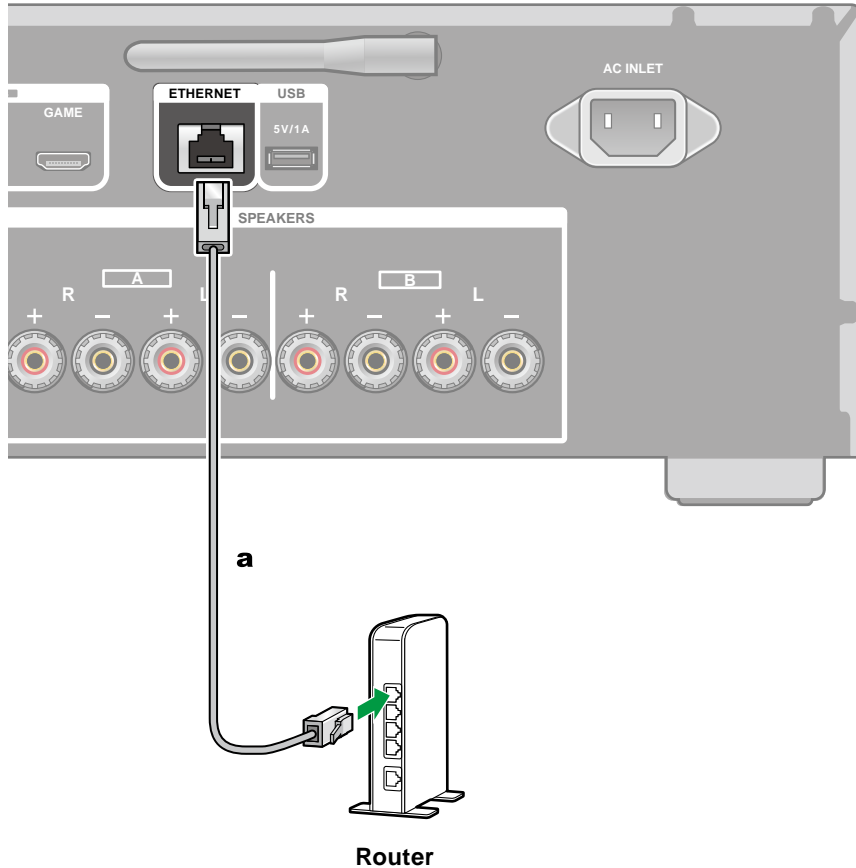

This unit can be connected to the network using a wired LAN or Wi-Fi (wireless LAN). You can enjoy network functions such as Internet radio by network connection. If connection is made by the wired LAN, connect the router and the ETHERNET jack with the Ethernet cable as shown in the illustration. To connect by Wi-Fi, select your desired setting method in "2. Connect the unit to Wi-Fi" (→[p34](#)) of Initial Setup, and then follow the on-screen instructions. To configure the setting on the Setup menu after the completion of Initial Setup, press the SETUP button on the remote controller, and select "3. Network" to make the setting (→[p81](#)). For the Wi-Fi connection, stand the wireless antenna for use.

Note

- For security reasons, always connect via a router, etc., when connecting this unit to the Internet. Do not directly connect to the communication circuits (including public wireless LAN) of a telecommunications provider (mobile communications company, fixed-line communications company, Internet provider, etc.).

a Ethernet cable



Connecting the Power Cord

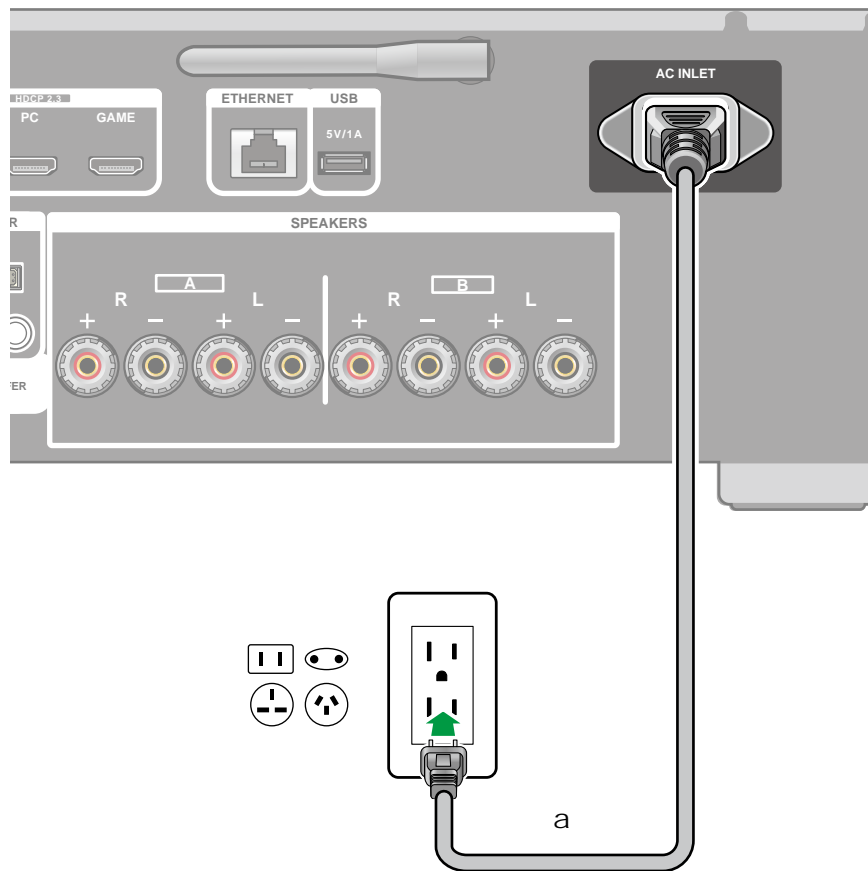

Connect the power cord after all the connections are completed.

- This model includes a removable power cord. Be sure to connect the power cord to the AC INLET of the unit first, and then connect it to the outlet. Always disconnect the outlet side first when disconnecting the power cord.

Note

Japanese models

- Match the power polarity to improve sound quality. Put the side of the power plug included with this unit with the "N" mark into the side of the outlet with the longer slot. If both slots are the same length, then you can plug it in either side.

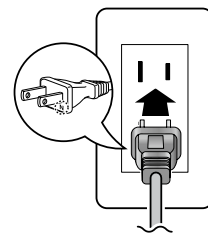

a Power cord



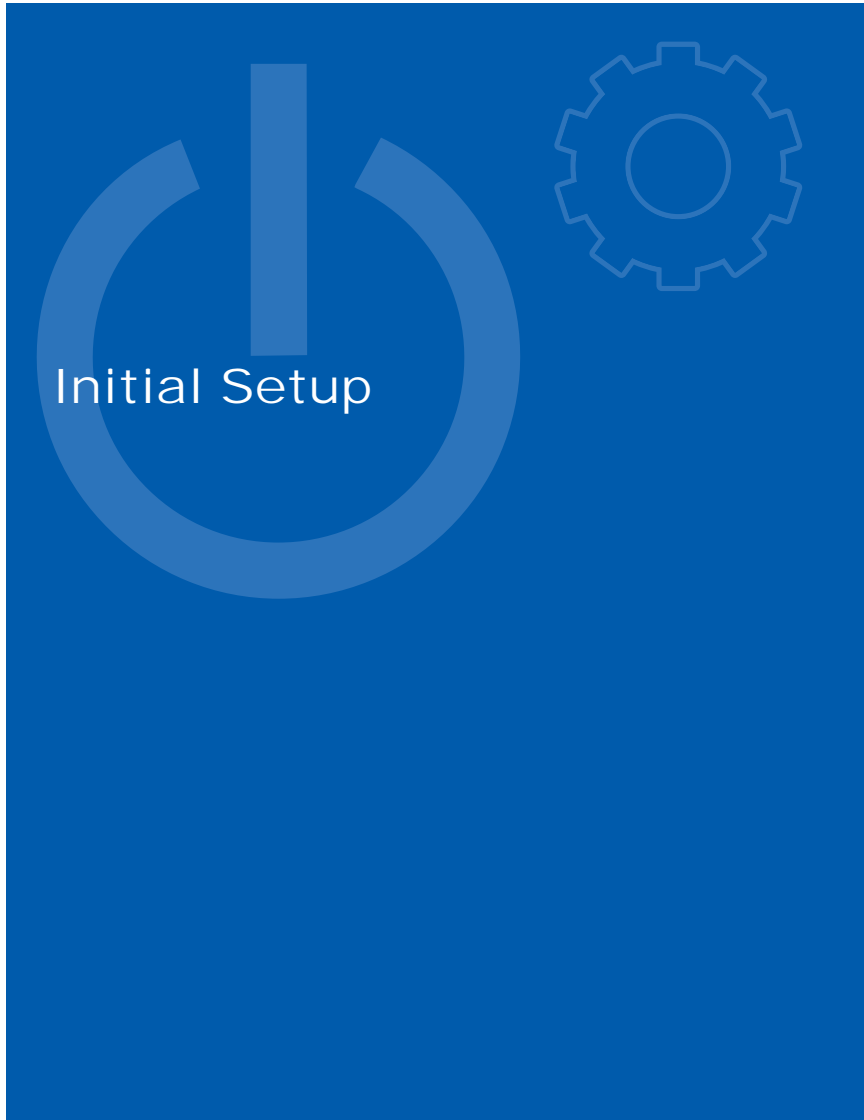

Before starting the procedure	33
1. Install the app	33
2. Connect the unit to Wi-Fi	34
Set the impedance	34



Before starting the procedure

Initial Setup starts when you turn on the power after purchasing the unit. An app is used during Initial Setup to connect the unit to Wi-Fi (wireless LAN).

Download

- To perform Initial Setup later, press SETUP or RETURN.
- If a Wi-Fi connection is not established, or if a wired LAN connection is not made, Initial Setup is displayed again when you turn the power on.

1. Install the app



Onkyo Controller (available on iOS and Android™ handsets) is a dedicated app available for free which allows you to use your handset as a remote controller. You have operations such as Wi-Fi (wireless LAN) settings for the unit, input switching, volume adjustments, and network services (Internet radio and music file playback) at your fingertips.

Main features

- Setting the Wi-Fi (wireless LAN) for the unit.
- Turning the power on/off, switching input, adjusting the volume, and other such basic remote controller operations.
- When using Multi-zone (→p61), you can not only control with the app in the main room (where this unit is located), but also in the separate room (ZONE 2).
- Playing internet radio services (TuneIn Radio, etc.) and selecting stations. Control in the palm of your hands without looking at the TV.
- Play the music files saved on the mobile device via Wi-Fi.
- Play Amazon Music (compatible models only) (→p54)

1. Download the Onkyo Controller from the App Store or Google Play™ Store. If it has already been downloaded, then it is updated to the latest version.



2. Connect the unit to Wi-Fi

1. Turn on the power of the unit.
2. Start Onkyo Controller. The search for this unit starts automatically when you start the app.
3. When this unit appears in the list of devices, tap it to select it.

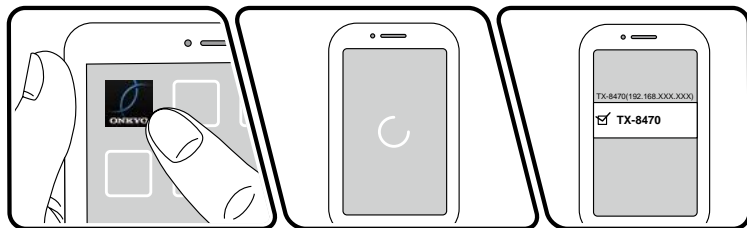

4. Follow the guidance in the app to connect this unit via Wi-Fi.

Set the impedance

If any of the connected speakers have 4 Ω or more to less than 6 Ω impedance, and it is anticipated that they will be used continuously at full power, you have to set the impedance. Press the SETUP button on the remote controller, then set "1. Audio" - "Speaker Impedance" (→[p78](#)) to "4ohms".



Basic Operations

Basic Operations	36
Bluetooth® Playback	40
Listening To the Radio	44

Network Services

Spotify	49
AirPlay®	50
Amazon Alexa	52
Amazon Music	54
TIDAL	56
Connecting the Sonos System for Playback	57
Internet Radio	59

Convenience functions

Multi-zone	61
Playing different audio and video	64
Using MY INPUT	65
Playing music files saved on a USB storage device	66
Music Server	68
Play Queue	71

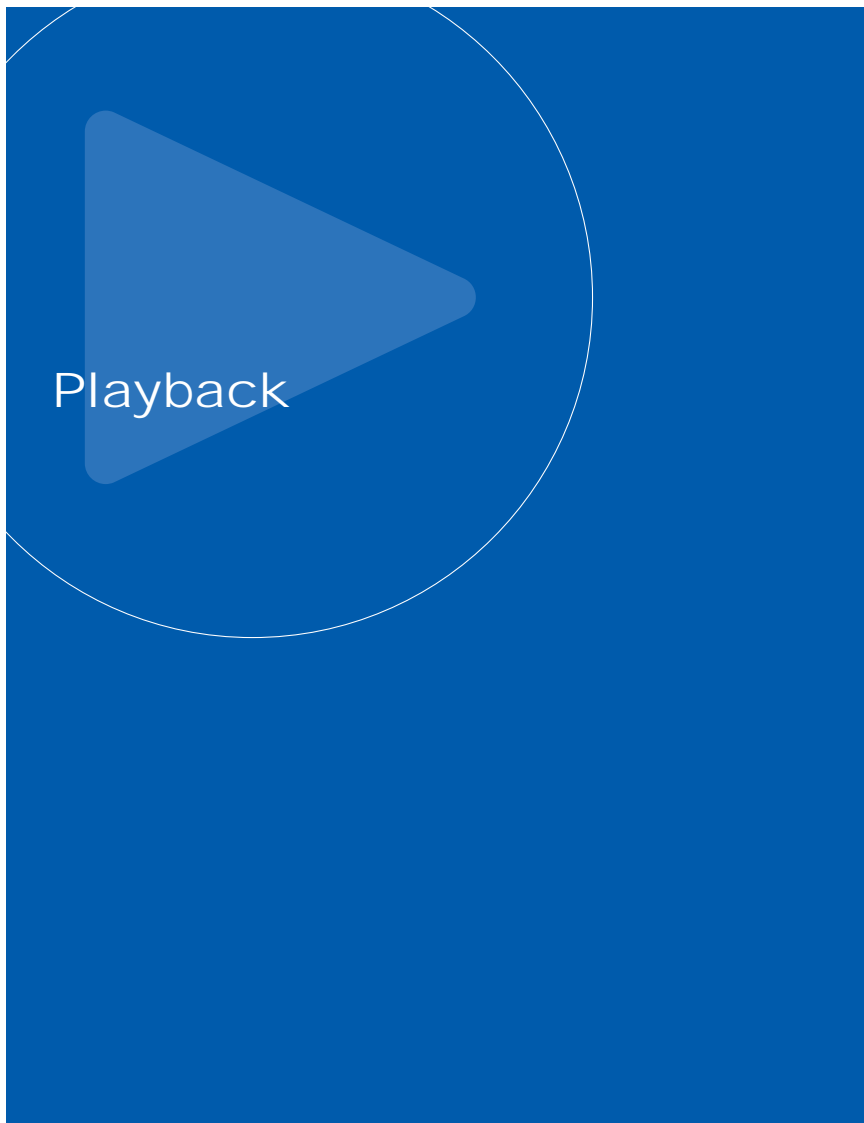

Basic Operations

Turning the power on

1. Press $\text{\textcircled{P}}$ ON/STANDBY on the remote controller to turn on the power of the unit.
 - If there is no response to the remote controller, press the REMOTE MODE MAIN button at the top of the remote controller once to switch the remote controller to the main mode.

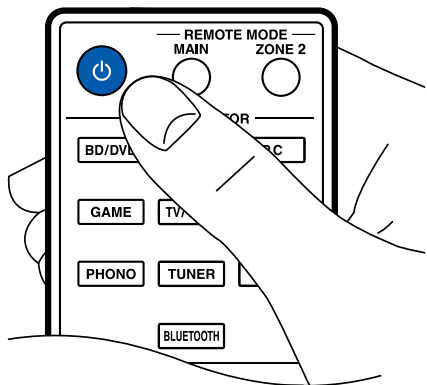

You can also turn on the power of the unit with the following operations:

- Pressing $\text{\textcircled{P}}$ ON/STANDBY on the main unit.
- Using the Onkyo Controller app (→ [p33](#))
- Using the linking function (HDMI CEC) (→ [p38](#))

Selecting a source to play

1. Press an input selector button on the remote controller to select a source. For example, to play the device connected to the BD/DVD jack, press the BD/DVD button. To listen to the audio of the TV, press TV/TAPE button.
 - If there is no response to the remote controller, press the REMOTE MODE MAIN button at the top of the remote controller once to switch the remote controller to the main mode.

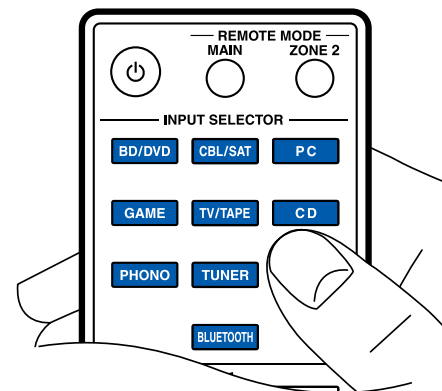

You can also select a source to play with the following operations:

- Turning the INPUT dial on the main unit.
- Using the Onkyo Controller app (→ [p33](#))



Adjusting the volume

1. Press the VOLUME buttons on the remote controller to adjust the volume. To temporarily turn off the sound, press the MUTING button. Press again to cancel.
- If there is no response to the remote controller, press the REMOTE MODE MAIN button at the top of the remote controller once to switch the remote controller to the main mode.
- Depending on the video signal, the volume bar on the TV screen changes from blue to magenta.

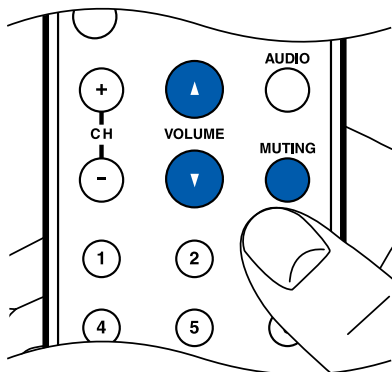

You can also adjust the volume with the following operations:

- Using the VOLUME dial on the main unit
- Using the Onkyo Controller app (→[p33](#))
- Using the linking function (HDMI CEC) (→[p38](#))

Adjusting the sound quality and left/right volume balance

1. Press AUDIO on the remote controller.
2. Press the cursor buttons \wedge / \vee UP/DOWN to select the item, then use the \langle / \rangle LEFT/RIGHT buttons to change the settings.

Bass: Enhance or moderate the low pitched range. *1

Treble: Enhance or moderate the high pitched range. *1

Balance: Adjust the balance of the sounds output from the left and right speakers.

Direct: Enable/disable the Direct function which outputs pure sound as it was intended by bypassing the tone control circuits during play.

3. To exit the settings, press RETURN.

- If there is no response to the remote controller, press the REMOTE MODE MAIN button at the top of the remote controller once to switch the remote controller to the main mode.

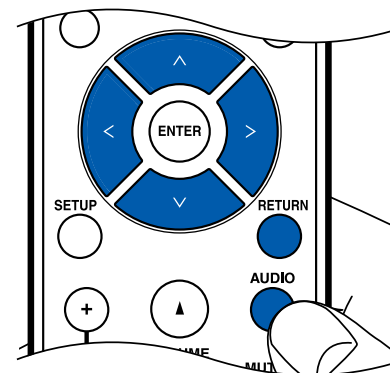

*1 It cannot be set if the listening mode is Pure Audio or Direct.

You can also adjust the sound quality with the following operations:

- Turning the BASS, TREBLE, and BALANCE dials on the main unit
- Using the Onkyo Controller app (→[p33](#))



Switching speakers

When you have connected two sets of speakers to this unit, you can select which set to output the sound.

1. Press SPEAKER A/B on the remote controller.
 - The selection changes in the order SPEAKER A, SPEAKER B, SPEAKER A+B with each press.
 - If there is no response to the remote controller, press the REMOTE MODE MAIN button at the top of the remote controller once to switch the remote controller to the main mode.

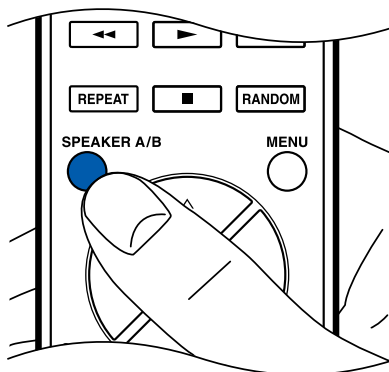

You can also switch speakers with the following operations:

- Pressing SPEAKER A/B on the main unit

Using the linking function (HDMI CEC)

By using an HDMI cable and connecting to a TV that is compatible with the HDMI CEC (Consumer Electronics Control) function, you are able to perform operations such as adjusting the volume of this unit with the TV's remote controller and link power On/Off. Furthermore, if you have connected a Blu-ray Disc player, Game console, etc. that is compatible with the HDMI CEC function, input switching is performed automatically.

- HDMI CEC settings (→p79) (the default value is "On")
- For information about the HDMI CEC functions of the TV, refer to the operating instructions, etc., for the TV.
- The unit is designed to link with products that comply with the CEC standard, and that linked operation is not always guaranteed with all CEC devices.
- For linked functions to work properly, do not connect CEC-compliant devices exceeding the connectable number to the HDMI jack as shown below.
 - Blu-ray Disc/DVD players: up to 3 units
 - Blu-ray Disc/DVD recorders: up to 3 units
 - Cable TV tuner, terrestrial digital tuner, and satellite broadcasting tuner: up to 4 units



Switching the display

Repeatedly pressing the DISPLAY button on the remote controller switches the display of the main unit in the following order.

- The content displayed depends on the source, Bluetooth, etc., being played.
- Not all the information is necessarily displayed.

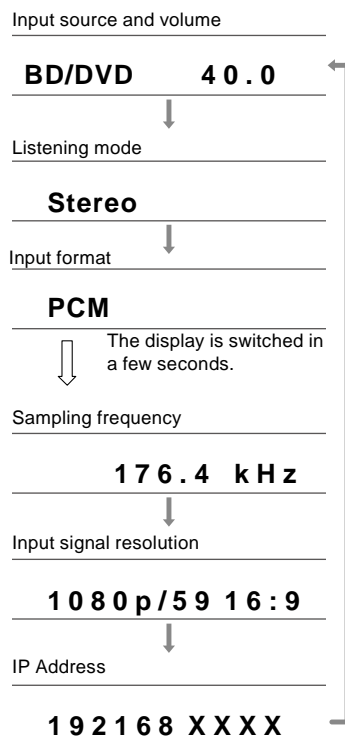

Bluetooth® Playback

You can wirelessly play music on a smartphone or other Bluetooth wireless technology enabled device through the speakers connected to this unit. It is also possible to transmit the audio from this unit to Bluetooth enabled headphones, wireless speakers, etc.

Playing audio from Bluetooth wireless technology enabled devices with this unit

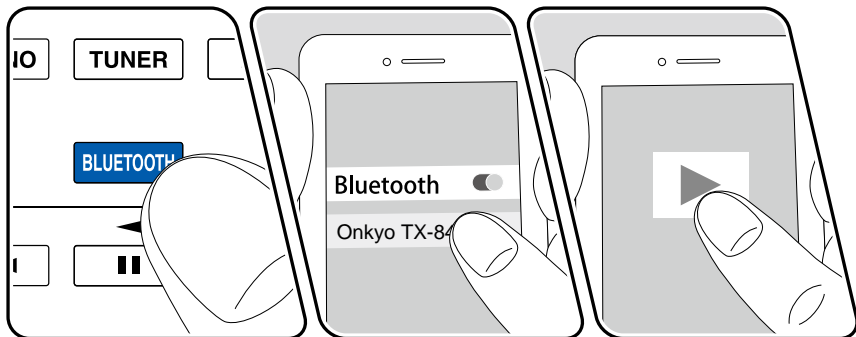
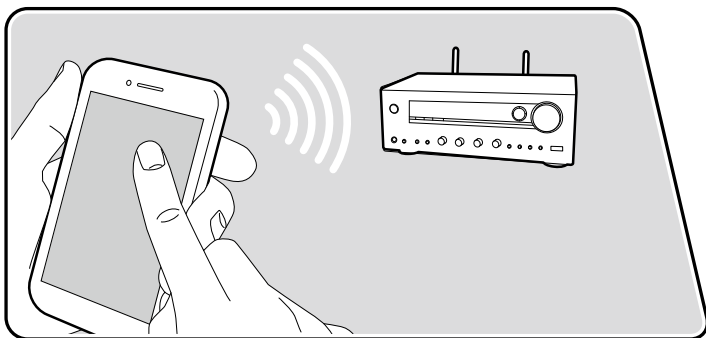

The illustration shows an image.

Perform the following procedure when this unit is on.

Pairing

1. When you press the BLUETOOTH button, "Now Pairing..." appears on the display, and the pairing mode is enabled.

Now Pairing . . .

2. Enable (turn on) the Bluetooth function of the Bluetooth enabled device, and then select this unit from among the devices displayed. If a password is requested, enter "0000".
 - This unit is displayed as "Onkyo TX-8470 XXXXXX". This display can be changed using the Friendly Name function (→p82) or Onkyo Controller (→p33) (available on iOS or Android™).
 - To connect another Bluetooth enabled device, press and hold the DISPLAY button at least 2 seconds, and then perform step 2. This unit can store the pairing information of up to 8 paired devices.
 - The coverage area is approx. 48/15 m. Note that connection is not always guaranteed with all Bluetooth enabled devices.
 - If pairing fails, then in the Setup menu, set "4. Bluetooth" - "Bluetooth Transmitter" (→p85) to "Off" and "Bluetooth Receiver" (→p84) to "On".



Playing Back

1. Perform the connection procedure on the Bluetooth enabled device.
2. Playing the music file.

The input on this unit automatically switches to "BLUETOOTH".

Turn up the volume of the Bluetooth enabled device to an appropriate level.

- Due to the characteristics of Bluetooth wireless technology, the sound produced on this unit may slightly be behind the sound played on the Bluetooth enabled device.



Transmitting audio from this unit to Bluetooth wireless technology enabled devices

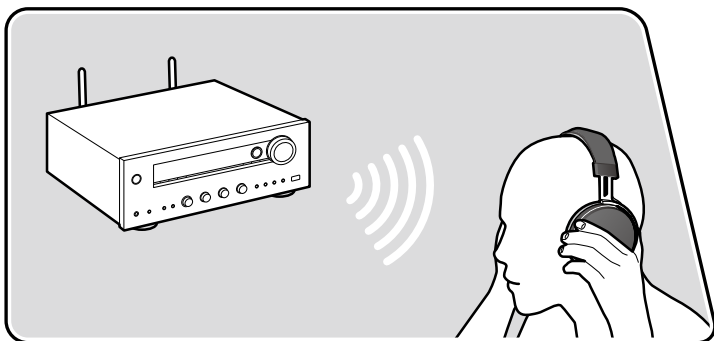

The illustration shows an image.

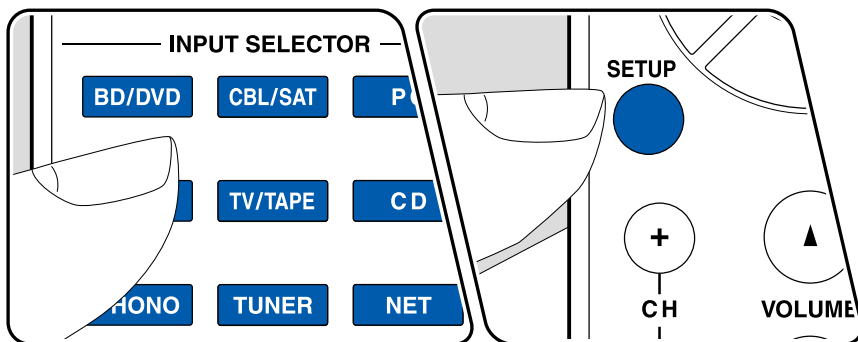

Pairing

1. Press the input selector you want to play.
 - Select a source other than "BLUETOOTH". This function does not work if you select "BLUETOOTH".
2. Press the SETUP button on the remote controller, select "4. Bluetooth" - "Bluetooth Transmitter", and select either "On (Tx)" or "On (Main + Tx)" in "Bluetooth Transmitter". (Default value is "Off")
 - If you select "On (Tx)", playback is from the Bluetooth wireless technology enabled device only, and if you select "On (Main + Tx)", playback is from both the Bluetooth wireless technology enabled device and the main unit.

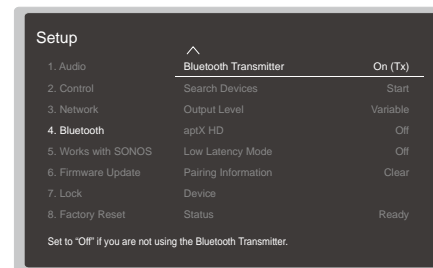

3. In "Search Devices", press ENTER.
 - The search starts for Bluetooth wireless technology enabled devices that are able to receive, then a list of relevant devices is displayed.
4. Select the device you want to output the audio from, and when you press ENTER the message "Now Pairing..." is displayed and the two are paired.
 - Depending on the Bluetooth wireless technology enabled device, you may need to pair manually. If the device name does not appear in the list, check the settings of the Bluetooth wireless technology enabled device.



Playing Back

1. Do the play operations on the AV component connected to this unit. Do the play operations on this unit when the input is TUNER or NET.
 - If "Variable" has been selected for the "Output Level", the volume can be adjusted on this unit. Adjust to a suitable volume on the connected Bluetooth wireless technology enabled device beforehand. If "Fixed" is selected, adjust the volume on the Bluetooth wireless technology enabled device.
 - You cannot transmit audio to multiple Bluetooth wireless technology enabled devices from this unit.
 - The coverage area is approx. 48'15 m. Note that connection is not always guaranteed with all Bluetooth enabled devices.
 - When "Bluetooth Transmitter" is "On (Tx)" or "On (Main + Tx)" and in the following cases, when this unit detects a paired Bluetooth wireless technology enabled device, it will automatically reconnect with that device.
 - When the power is turned on again after the unit is switched to standby
 - While other than "BLUETOOTH" is selected
 - When the "NET" input is selected and there is audio output from a network service/content (some services excluded)

When not using this function, select "Off" in "Bluetooth Transmitter" to cancel the connection. Also disconnect on the receiving device (if disconnection is possible on the receiving device).

- Audio cannot be output from a Bluetooth wireless technology enabled device in the following cases:
 - When the audio file is DSD format
 - When playing audio from one of the following network services: Chromecast built-in, Amazon Alexa, AirPlay

*The services may not be available, depending on your area of residence.
- Sound quality adjustments and listening modes of this unit cannot be applied to the output audio.
- This function can be used in the main room (where this unit is located). This function turns off if you turn on the Multi-zone function which outputs audio from a separate room (ZONE 2).



Listening To the Radio



You can receive AM (North American models)/FM (North American and European models)/DAB (European models) radio on this unit with the built-in tuner.

Listening To the AM/FM Radio

Perform the following procedure when this unit is on.

■ Tuning Automatically

1. Press the TUNER button on the remote controller repeatedly to select either "AM" or "FM".
2. Press the TUNING MODE button on the main unit repeatedly to display "TunMode: Auto" on the display.

TunMode: Auto

3. When you press the cursors \wedge / \vee UP/DOWN, automatic tuning starts, and searching stops when a station is found. When tuned in to a radio station, the "TUNED" indicator on the display lights up. When tuned in to an FM radio station, the "FM ST" indicator lights up.

When FM broadcasts reception is poor: Perform the procedure for "Tuning Manually" (→p44). Note that if you tune manually, the reception for FM broadcasts will be monaural rather than stereo, irrespective of the sensitivity of the reception.

■ Tuning Manually

Note that if you tune manually, the reception for FM broadcasts will be monaural rather than stereo, irrespective of the sensitivity of the reception.

1. Press the TUNER button on the remote controller repeatedly to select either "AM" or "FM".
2. Press the TUNING MODE button on the main unit repeatedly to display "TunMode: Manual" on the display.

TunMode: Manual

3. While pressing the cursors \wedge / \vee UP/DOWN, select the desired radio station.
 - Each time you press the cursors \wedge / \vee UP/DOWN, the frequency changes by 1 step. If the button is held down, the frequency changes continuously, and if the button is released, the frequency stops changing.

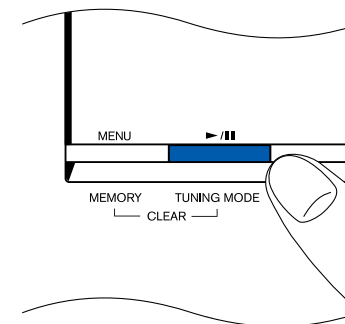
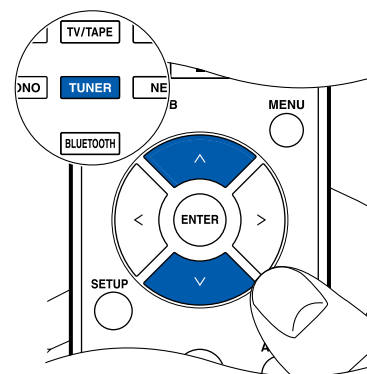

■ Frequency step setting (North American models)

Press the SETUP button, and using the cursors and ENTER, select "1. Audio" - "AM/FM Frequency Step", and then select the frequency step for your area. Note that when this setting is changed, all radio presets are deleted.



□ Presetting a Radio Station (→ [p48](#))



Using RDS (European models only)

RDS stands for Radio Data System, and is a method of transmitting data in FM radio signals. In regions where RDS can be used, when you tune in to a radio station broadcasting program information, the radio station name is displayed on the display. When you press the RT/PTY button on the main unit in this state, you can use the following functions.

■ Display Text Information (Radio Text)

1. While the name of the station is being displayed on the display, press the RT/PTY button on the main unit once.

The Radio Text (RT), which is text information delivered by the station, is displayed scrolling across the display. "No Text Data" is displayed when no text information is delivered.

■ Search for Stations by Program Type

1. While the name of the station is being displayed on the display, press the RT/PTY button on the main unit twice.
 - If none of the Program Types are set for the radio station under reception, "None" is displayed.
2. Press the cursor buttons </> LEFT/RIGHT on the remote controller to select the Program Type you want to search for, and then press the ENTER button to start the search.
 - The Program Types displayed are as follows: None / News (News reports) / Affairs (Current affairs) / Info (Information) / Sport / Educate (Education) / Drama / Culture / Science (Science and technology) / Varied / Pop M (Pop music) / Rock M (Rock music) / Easy M (Middle of the road music) / Light M (Light classics) / Classics (Serious classics) / Other M (Other music) / Weather / Finance / Children (Children's programmes) / Social (Social affairs) / Religion / Phone In / Travel / Leisure / Jazz (Jazz music) / Country (Country music) / Nation M (National music) / Oldies (Oldies music) / Folk M (Folk music) / Document (Documentary)
 - The information displayed may not match the content delivered by the station.
3. When a station is found, the station blinks on the display. Pressing the ENTER button in this state will receive that station. If you don't press the

ENTER button, the unit starts to search for another station.

- If no stations are found, the message "Not Found" is displayed.
- Unusual characters may be displayed when the unit receives unsupported characters. This is not a malfunction. Also, if the signal from a station is weak, information may not be displayed.

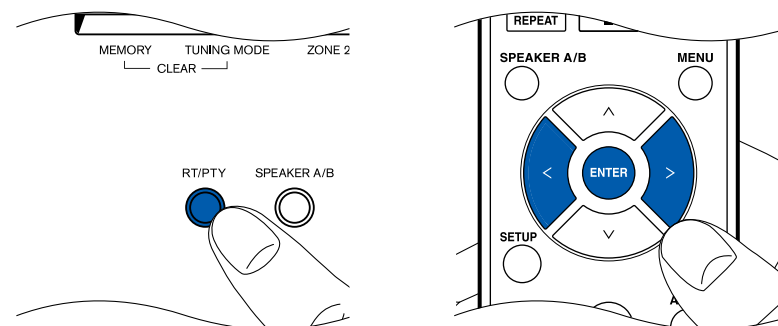

□ Presetting a Radio Station (→p48)



Listening To DAB Digital Radio (European models only)

Perform the following procedure when this unit is on.

1. Press TUNER repeatedly to select "DAB".
 - The very first time you select DAB, the Auto Tuning function automatically scans the DAB Band 3 for the multiplexes (i.e., stations) available in your area. Once the scanning process is complete, the first station that was detected is selected.

Scan: 100%

2. Select the desired radio station with ^ / v UP/DOWN.
 - If a new DAB station is introduced, or you move to a new area, press the SETUP button on the remote controller, then use the cursors and ENTER button to run the "1. Audio" - "DAB Auto Scan".

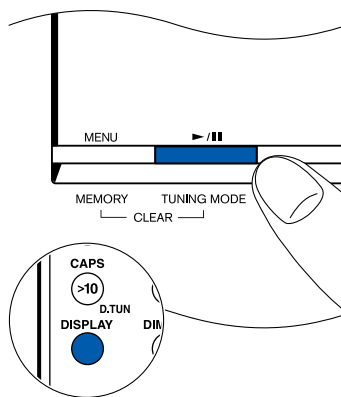
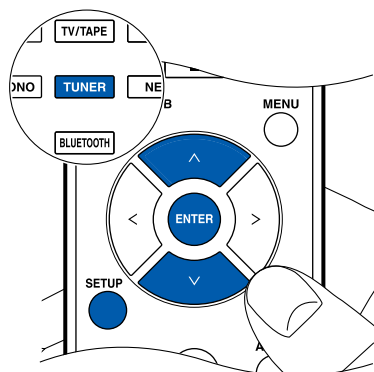

■ Changing how stations are sorted

You can sort the available stations alphabetically or by multiplex.

1. Press the TUNING MODE button on the main unit repeatedly to set the method for sorting the display order from the following.
 - Alphabet** (default setting): Sort stations alphabetically.
 - Multiplex**: Sort stations by multiplex.

■ Displaying DAB Radio Information

1. Press DISPLAY button repeatedly to display more information about the selected DAB station.

DLS (Dynamic Label Segment) : When tuned to a station that's broadcasting DLS text data, the text will scroll across the display.

Program Type : Displays the type of program.

Bit Rate and Audio Mode : Displays the station's bit rate and audio mode (Stereo, Mono).

Quality : Displays the signal quality.

0 - 59: Poor reception

60 - 79: Good reception

80 - 100: Excellent reception

Multiplex Name : Displays the name of the current multiplex.

Multiplex Number and Frequency :

Displays the number and frequency of the current multiplex.

□ Presetting a Radio Station (→p48)



Presetting a Radio Station

Registration Procedure

You can preset up to 40 of your favorite radio stations.

After tuning in to the radio station you want to register, perform the following procedure.

1. Press MENU button on the remote controller so that the preset number on the display blinks.

FM 87.5 MHz 1

2. While the preset number is blinking (approx. 8 seconds), repeatedly press the cursors </> LEFT/RIGHT to select a number between 1 and 40.
3. Press MENU button on the remote controller again to register the station. When the station is registered, the preset number stops flashing. Repeat this procedure for all of your favorite radio stations.

You can also register radio stations with the following operations:

- Pressing MEMORY on the main unit.
- Using the Onkyo Controller app (→p33)

Selecting a Preset Radio Station

1. Press TUNER button on the remote controller.
2. Press the cursors </> LEFT/RIGHT to select a preset number.

Deleting a Preset Radio Station

1. Press TUNER button on the remote controller.
2. Press the cursors </> LEFT/RIGHT to select the preset number to delete.
3. While pressing MEMORY on the main unit, press TUNING MODE to delete the preset number. When deleted, the number on the display disappears.

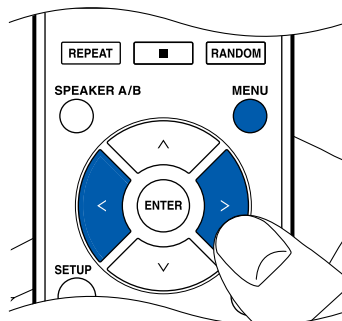
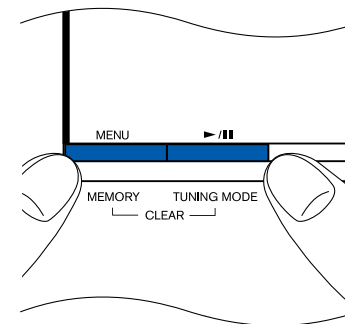
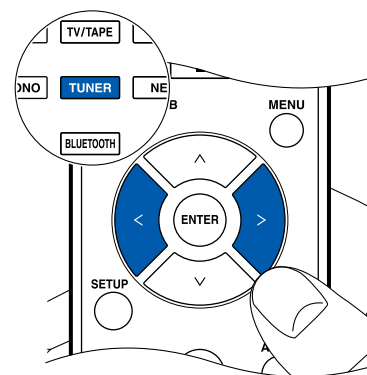

Spotify



Use your phone, tablet or computer as a remote control for Spotify.
Go to spotify.com/connect to learn how.

The Spotify software is subject to third party licenses found here:
<https://www.spotify.com/connect/third-party-licenses>



AirPlay®

By connecting this unit to the same network as that of iOS devices such as iPhone®, iPod touch® and iPad®, you can enjoy music files on iOS devices wirelessly.

- Update the OS version on your iOS device to the latest version.
- Depending on the iOS version, operation screens or operation procedures on the iOS device may be different. For details, refer to the operating instructions for the iOS device.

Basic Operations

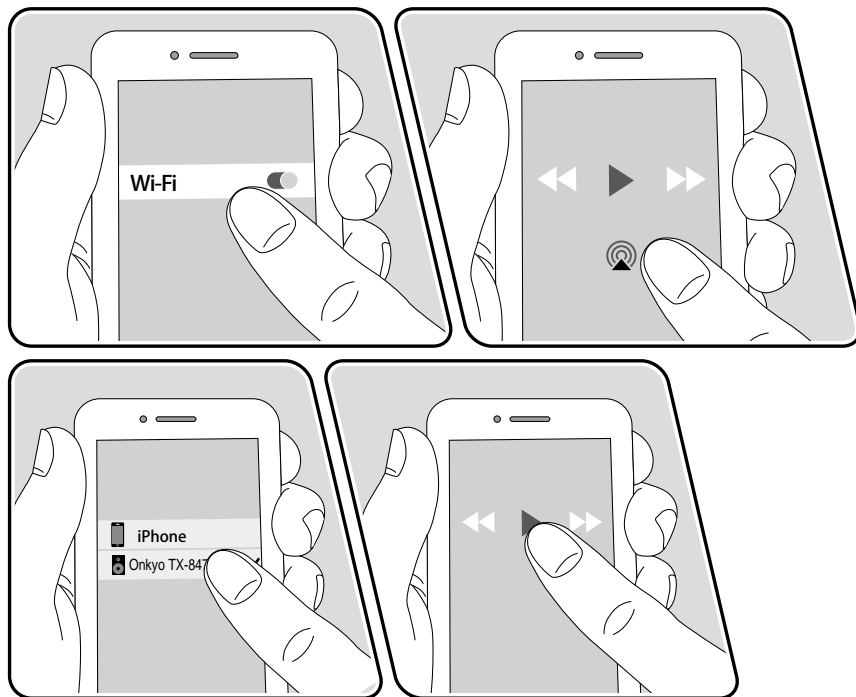

e.g., iOS 10

1. Connect the iOS device to the access point where this unit is connected via network.
2. Tap the AirPlay icon  in the play screen of the music app on an iOS device that supports AirPlay and select this unit from the list of devices displayed.
3. Play the music file on the iOS device.
 - When "2. Control" - "Network Standby" is set to "Off" in the Setup menu, turn this unit on manually, and press the NET button on the remote controller. In the factory default setting, the Network Standby function (→p80) is set to On.
 - Due to the characteristics of AirPlay wireless technology, the sound produced on this unit may slightly be behind the sound played on the AirPlay-enabled device.

You can also play the music files on a PC with iTunes (Ver. 10.2 or later) equipped. Confirm that this unit and the PC are connected to the same network beforehand. Then, press NET on the remote controller. Next, click the AirPlay icon  in iTunes, select this unit from the displayed devices, and start play of a music file.



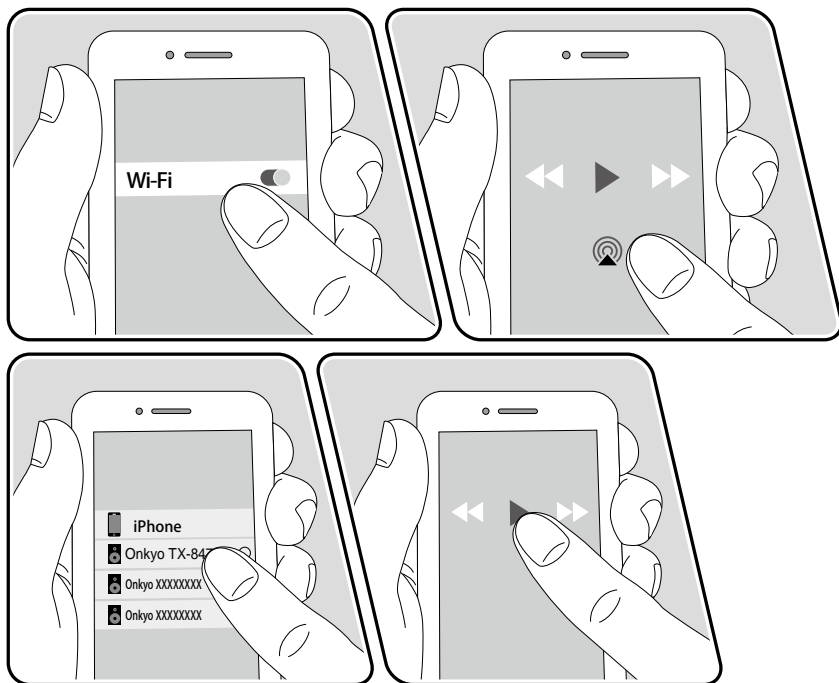

Playing Back on multiple devices (AirPlay2)



e.g., iOS 11.4

This unit supports AirPlay2. If the version of the iOS device is iOS11.4 or later, you can play the tracks on the iOS device simultaneously on this device and on another device that supports AirPlay2.

1. Connect the iOS device to the access point where this unit is connected via network.
2. Tap the AirPlay icon  on the play screen of the music play application on the iOS device, and select this unit and AirPlay2-supported devices to play from the displayed devices.
 - AirPlay2-supported devices are displayed with white circle on the right side.
 - Multiple AirPlay2-supported devices can be selected.
 - The volume can be adjusted on individual devices.
3. Play the music file on the iOS device.
 - When "2. Control" - "Network Standby" is set to "Off" in the Setup menu, turn this unit on manually, and press the NET button on the remote controller. In the factory default setting, the Network Standby function (→p80) is set to On.
 - Due to the characteristics of AirPlay wireless technology, the sound produced on this unit may slightly be behind the sound played on the AirPlay-enabled device.

You can also play the music files on a PC with iTunes (Ver. 12.8 or later) equipped. Confirm that this unit and the PC are connected to the same network beforehand. Then, press NET on the remote controller. Next, click the AirPlay icon  in iTunes, select this unit and AirPlay2-supported devices to play from the displayed devices, and start play of a music file.



Amazon Alexa

Alexa is a cloud-based voice service developed by Amazon. When this unit is registered with an Amazon account, you can use a terminal with Amazon Alexa (an Amazon Echo, etc.) or Amazon Alexa App (available on iOS and Android™) to perform operations such as adjusting the volume of this unit or playing music using voice commands.

- You need an Amazon account to use Amazon Alexa. For more information, see the Amazon website.
- The services may not be available, depending on your area of residence.

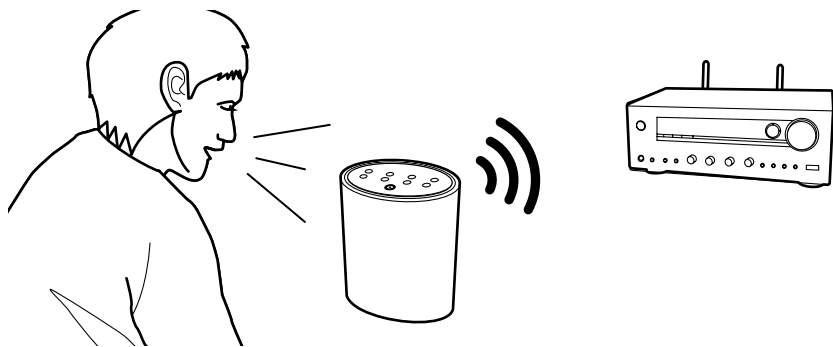

Registering this unit with an Amazon account

1. Register with the Amazon account on Onkyo Controller. This cannot be set with operations on this unit.
Refer to "1. Install the app" (→p33) for information about the app.
2. Start Onkyo Controller and tap the unit when displayed.
3. Tap "NET" or "NETWORK" on the upper part of the Onkyo Controller's screen to switch to the network menu.
4. Tap the "amazon Alexa" icon.
 - If the login screen is not displayed, but rather a screen prompting updates or installation of the ID authentication app (Service Unlocker), then follow the on screen instructions to update and install first.

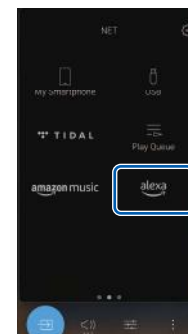

Available services may differ depending on your area.

5. Tap "Start Setup", and in the Setup screen, select the language and register the device name. Select the same language as the one you have selected for your other terminals with Amazon Alexa (an Amazon Echo, etc.). For the device name, use one that can easily be called up vocally.
For example: Speaker
6. Tap "Next" to display the Amazon Alexa screen.



7. Follow the on screen instructions to enter the Amazon account information, such as your email address and password, to log into Amazon (*1). After logging in, tap "Allow" and register this unit with an Amazon account. (*1) Log in using the same account as other terminals with Amazon Alexa.
8. When registration is finished, the screen returns to the one for Onkyo Controller. Follow the on screen instructions and talk to the terminal with Amazon Alexa (an Amazon Echo, etc.), and confirm that you can use voice commands.
 - For example: "Alexa, raise the volume of the speaker (*2)"
 - "Alexa, play music from the speaker (*2)"
 - (*2) Use the device name you registered in Step 5 when talking.

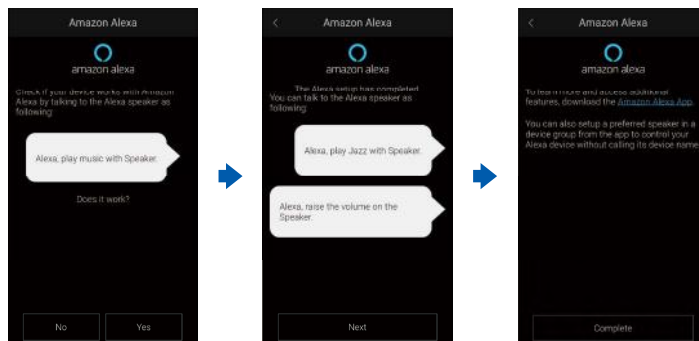

Operating this unit

You can use voice commands to adjust the volume on this unit, start and stop music, and skip music up or down.

1. With the unit on, speak at the terminal with Amazon Alexa (an Amazon Echo, etc.). When using the Amazon Alexa app, after starting the app, tap the Alexa logo and speak at the mobile device.
 - For example: "Alexa, raise the volume of the speaker (*3)"
 - "Alexa, play music from the speaker (*3)"
 - (*3) Use the device name you registered in Step 5 of "Registering this unit with an Amazon account" when talking.

- Refer to the Amazon websites for information about operation of the Amazon Alexa app.



Amazon Music



Registering this unit with Amazon Music allows you to enjoy the music distribution service provided by Amazon.

- To play Amazon Music, you need to have your Amazon account and sign up for Amazon Prime or Amazon Music Unlimited. For more information, see the Amazon website.

Amazon Music is now available in several countries. If Amazon Music is not available in your country, please visit <https://music.amazon.com/> for more info.

Registering This Unit with Amazon Music

- Register with the Amazon account on Onkyo Controller. This cannot be set with operations on this unit.
Refer to "1. Install the app" (→p33) for information about the app.
- Start Onkyo Controller and tap the unit when displayed.
- Tap "NET" or "NETWORK" on the upper part of the Onkyo Controller's screen to switch to the network menu.
- Then tap the "Amazon Music" icon to display the login screen of Amazon Music. (Depending on the model, the icon names may be different.)
 - If the login screen is not displayed, but rather a screen prompting updates or installation of the ID authentication app (Service Unlocker), then follow the on screen instructions to update and install first.

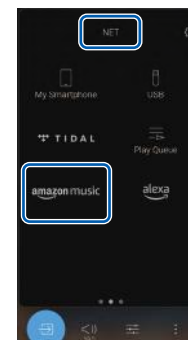

Available services may differ depending on your area.

- Enter the Amazon account information such as email address and password to log in to Amazon. When the login is successful and this unit is registered, the Amazon Music menu is displayed.
For playback, proceed to step 3 in the next section.



Playing Amazon Music using the Onkyo Controller

1. Start up Onkyo Controller. This unit is automatically displayed after startup. Then, tap and select this unit displayed.
2. Tap "NET" or "NETWORK" on the upper part of the screen to switch to the network screen. Then tap the "Amazon Music" icon.
3. Select the content to play from the menu screen of Amazon Music to start playback.

Playing Amazon Music using the remote controller

1. Switch the input on the TV to the input connected to the unit.
2. Pressing NET will display the Network Functions list screen on the TV.
3. Select "Amazon Music" with the cursors and press ENTER to confirm.
4. Select the content to play from the menu screen of Amazon Music to start playback.



TIDAL



Registering this unit with TIDAL allows you to enjoy the music distribution service provided by TIDAL. You can register this unit on the screen of Onkyo Controller by downloading Onkyo Controller (available on iOS or Android™) to mobile devices such as a smartphone and tablet.

- You need a TIDAL account to play back TIDAL. For more information, see the [TIDAL](#) website.
- The services may not be available, depending on your area of residence.



Registering this unit with TIDAL

- You can register this unit with TIDAL using Onkyo Controller. The registration cannot be performed by operation of this unit.
1. Connect this unit to your home network by the network settings on this unit.
 2. Download Onkyo Controller using your mobile device.
 3. Connect the mobile device to the network where this unit is connected.
 4. Start up Onkyo Controller to automatically display this unit. Tap and select this unit displayed.
 5. Tap "NET" or "NETWORK" on the upper part of the Onkyo Controller's screen to switch to the network menu. Then tap the "TIDAL" icon to display the login screen of TIDAL. (Depending on the model, the icon names may be different.)

- If the login screen is not displayed but an update or installation screen is displayed instead, perform the update or installation according to the onscreen instructions.

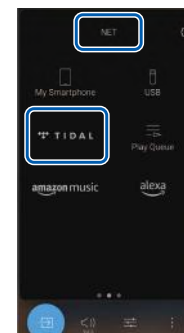

Available services may differ depending on your area.

6. Enter the TIDAL account information such as login ID and password to log in to TIDAL. When the login is successful and this unit is registered, the TIDAL menu is displayed.
For playback, proceed to step 3 in the next section.

Playing TIDAL

1. Start up Onkyo Controller. This unit is automatically displayed after startup. Then, tap and select this unit displayed.
2. Tap "NET" or "NETWORK" on the upper part of the screen to switch to the network screen. Then tap the "TIDAL" icon.
3. Select the content to play from the menu screen of TIDAL to start playback.
 - To play TIDAL using the remote controller, operate the input selector on the remote controller to display the network menu, and select "TIDAL" from the menu.



Connecting the Sonos System for Playback



Connecting this unit and Sonos Port allows you to send the music or music sources on the Sonos App to this unit. Through Sonos Port, you can play this unit with the same group of another Sonos device on the network or can play only on this unit. Also, if you start to play music from Sonos App, this unit is automatically turned on and the link function to switch input works.

- When "2.Control" - "Network Standby" is set to "Off" in the Setup menu, turn this unit on manually, and press the NET button on the remote controller. In the factory default setting, the Network Standby function (→ [p80](#)) is set to On.
- You can register a maximum of 2 Sonos Port.

Necessary Equipment

- Sonos Port
- RCA audio cable (supplied with Sonos Port)

How to Connect This Unit and Sonos Port

1. Connect the Sonos Port to the AUDIO IN jack of this unit with the RCA audio cable supplied with the Sonos Port. Any input jacks other than the PHONO jack can be used.
 - A digital cable can also be connected. For details, refer to the instruction manual of Sonos.

Setting Up

A setup is required to play Sonos on this unit. Make the setting according to the following procedure.

1. Press the SETUP button on the remote controller, select "5. Works with SONOS", and press the ENTER button.
2. Select the following items with the cursors \wedge / \vee UP/DOWN and set each item.

Input Selector:

Enable the interlocking function with the Sonos Port. With the cursors \langle / \rangle LEFT/RIGHT, select the input selector to which the Sonos Port is connected.

Connected Device:

Press the ENTER button to display Sonos devices connected to the same network as the network of this unit. Select the Sonos Port connected to the unit and press the ENTER button.

- Products (e.g. Play:3 unequipped with an output terminal) other than the Sonos Port are also displayed in the device list and selectable. In that case, when playback on the Sonos side starts, the input is switched, however, audio is not output. Select the room name of the connected Sonos Port.
- Up to 32 devices can be displayed on the Sonos product list screen. If you cannot find the Sonos Port to be interlocked, return to the previous screen, turn off the product you do not want to interlock, and try again.



Output Zone:

With the cursors </> LEFT/RIGHT, select the ZONE where you want to listen to the music.

"Main": Outputs audio only to the main room (where this unit is located).

"Zone 2": Outputs audio only to the separate room (ZONE 2).

"Main/Zone 2": Outputs audio to both the main room and separate room (ZONE 2).

Preset Volume:

You can set the volume that Sonos Port will be played at beforehand. After pressing the ENTER button, press the cursor buttons </> LEFT/RIGHT to select a value from "Last" (Volume level before entering standby mode), "Min", "0.5" to "99.5" and "Max".

- When making the setting for the second unit, press the cursor ∨ DOWN several times to move to the next page, and change the menu from "SONOS-1" to "SONOS-2".

Playing Sonos on This Unit

1. Select desired tracks using Sonos App and send the tracks to the room where this unit is located (or to the group). It is recommended to give an easy-to-remember name to the combination of this unit and Sonos Port, such as TV Room or Living Room where this unit is located.
- If the input selector of this unit is not automatically switched even after the start of music playback, stop the playback once and start again.
 - When the "Volume Pass Through" mode has been selected with the Sonos App settings, you can use the Sonos App to control the volume of this unit.
 - * You cannot use the "Preset Volume" function when the "Volume Pass Through" mode has been selected.



Internet Radio

By connecting this unit to an Internet-connected network, you can enjoy Internet radio services such as TuneIn Radio.

- To play Internet radio services, the network needs to be connected to the Internet.
- Depending on the Internet radio service, a user registration may be required on your PC beforehand. For details of each service, visit the website of each service.

Playing Back

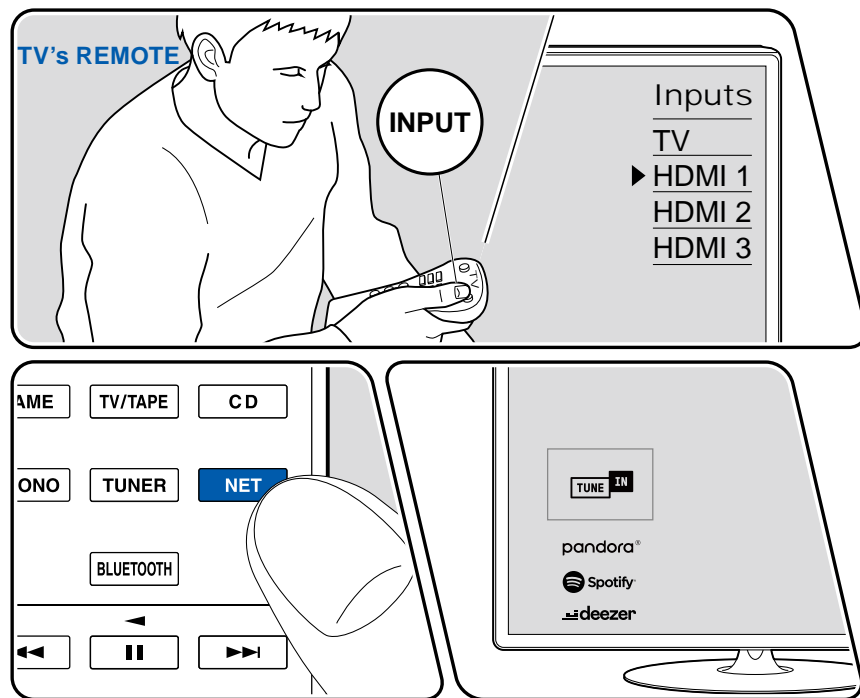

The illustration shows an image.



Perform the following procedure when this unit is on.

1. Switch the input on the TV to the input connected to the unit.
2. Pressing NET will display the Network services list screen on the TV.
3. Select your preferred Internet radio service using cursor, and press ENTER to confirm the selection.
4. Following the on-screen instructions, select a radio station and program using cursor, and then press ENTER to play.
 - To return to the previous screen, press RETURN.



Internet Radio Service Menu

You can bookmark specific stations, or delete stations that have been bookmarked. The displayed menu varies according to the service being selected.

The menu icon  is displayed while a station is being played. When only this icon is displayed, pressing ENTER will display the menu on the screen. When multiple icons are displayed, select the  icon with the cursor, and press ENTER.

Regarding the TuneIn Radio Account

If you create an account on the TuneIn Radio website (tunein.com), and log in it from this unit, your favorite radio stations or programs you have followed on the website are automatically added to your "My Presets" on this unit. "My Presets" is displayed on the next level in the hierarchical structure of TuneIn Radio. To display a radio station added to "My Presets", you need log into TuneIn Radio from the unit. To log in, select "Login" - "I have a TuneIn account" in the "TuneIn Radio" top list on the unit, and then enter your user name and password.

- If you select "Login" on this unit, a registration code is displayed. By using this code, you can associate the device on the My Page section of the TuneIn Radio website so that you can log in from "Login" - "Login with a registration code" without entering the user name and password.

radiko.jp premium (Japanese models)

If you have registered as a radiko.jp premium member, you will be able to listen to radio stations from all over Japan, even those outside your region, by logging in with this unit. In radiko.jp, select a radio station from outside your region, then press ENTER and log in using the following procedure:

1. The "Enter email address" message appears. Press ENTER and enter the email address used to register as a member. When you have finished entry, select "OK" and press ENTER.
2. Select "OK" with the cursors on the remote controller and press ENTER.
3. The "Enter password" message appears. Press ENTER and enter your password. When you have finished entry, select "OK" and press ENTER.
4. Select "OK" with the cursors on the remote controller and press ENTER.



Multi-zone

You can enjoy 2 ch audio in the separate room (ZONE 2) while performing playback in the main room (where this unit is located). The same source can be played back in the main room and ZONE 2 simultaneously.

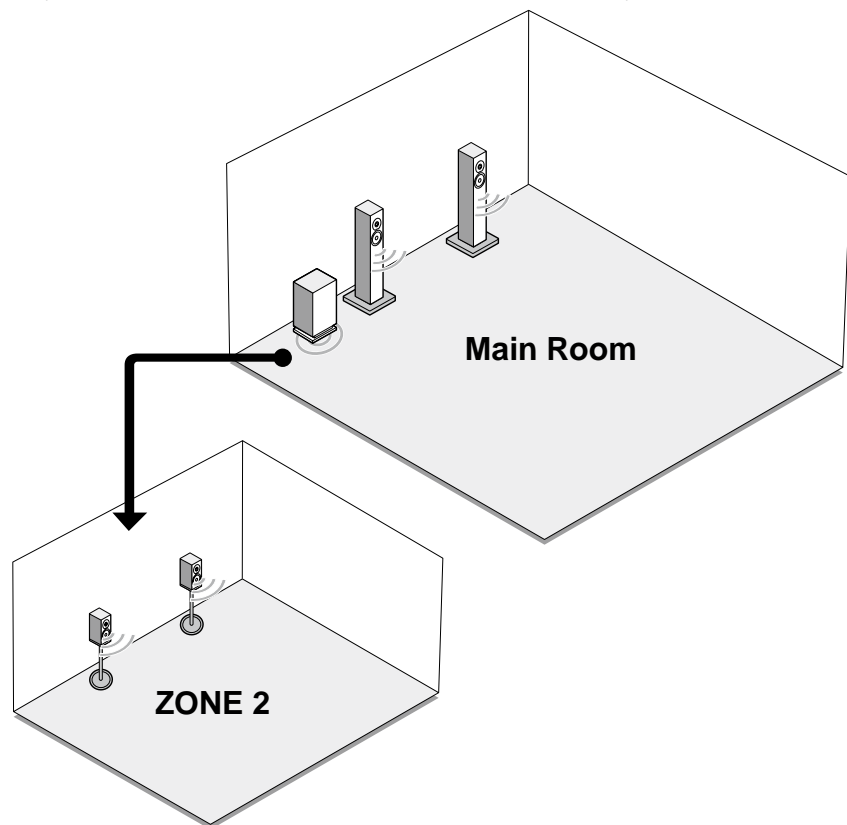

Using Onkyo Controller (→[p33](#)) is convenient for operations of multi-zone playback. You can use it on mobile devices, such as a smartphone and tablet to which Onkyo Controller (available on iOS or Android™) has been downloaded.



□ Playing Back (ZONE 2) (→[p62](#))



Playing Back (ZONE 2)

Note

- To output audio from an externally connected AV component to ZONE 2, use an analog audio cable for connection. Note that ZONE 2 output is not possible with the connection using an HDMI cable, digital coaxial cable, or digital optical cable
- You can only select the same source for the main room and separate room with the "NET" and "BLUETOOTH" input selectors. Furthermore, if you have "NET" selected in the main room and you then select "BLUETOOTH" in the separate room, the main room will also switch to "BLUETOOTH".
- It is not possible to select different stations in the main room and separate room with AM/FM broadcasts. (North American models)
- DSD audio signals cannot be output to ZONE 2 with the "NET" input selector.
- If ZONE 2 is on, power consumption during standby will increase.
- This function turns off if you use "Transmitting audio from this unit to Bluetooth wireless technology enabled devices" (→[p42](#)).

Turning ZONE 2 On/Off

1. Press REMOTE MODE ZONE 2 once on the remote controller.
 - The remote controller switches to the mode for controlling ZONE 2.
2. Press \odot ON/STANDBY on the remote controller. "Z2" lights in the main unit display when ZONE 2 turns on. To turn ZONE 2 off, repeat the same procedure.

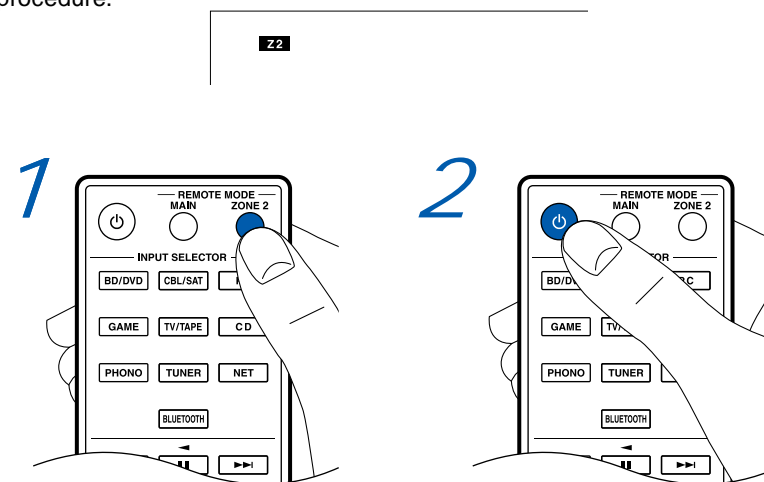

- To control on the main unit, press the ZONE 2 button twice on the main unit to turn it on. To turn off, after pressing the ZONE 2 button, press the OFF button that is next to it.
- When the power of this unit is switched to standby while using ZONE 2, the Z2 indicator lights dimly, and the mode switches to play only in the separate room. Furthermore, the mode switches to play only in the separate room when this unit is in standby mode and ZONE 2 is turned on.



Selecting a source to play in ZONE 2

1. Press REMOTE MODE ZONE 2 once on the remote controller.
 - The remote controller switches to the mode for controlling ZONE 2.
2. Press an INPUT SELECTOR button to select a source.

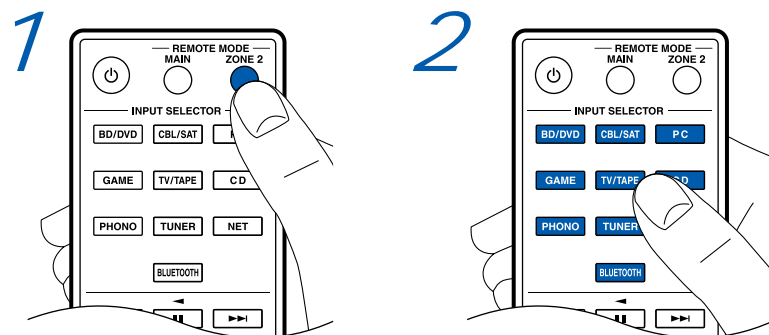

- To control on the main unit, after pressing the ZONE 2 button on the main unit, turn the INPUT dial to select the source to play. To play the source currently selected in ZONE 2, press the ZONE 2 button twice.

Adjusting the volume in ZONE 2

When using an integrated amplifier that has a volume control

Use the volume control on the integrated amplifier to adjust the volume.

When connecting an integrated amplifier that does not have a volume control

1. Press REMOTE MODE ZONE 2 once on the remote controller.
 - The remote controller switches to the mode for controlling ZONE 2.
2. Press the VOLUME buttons to adjust the volume in ZONE 2.

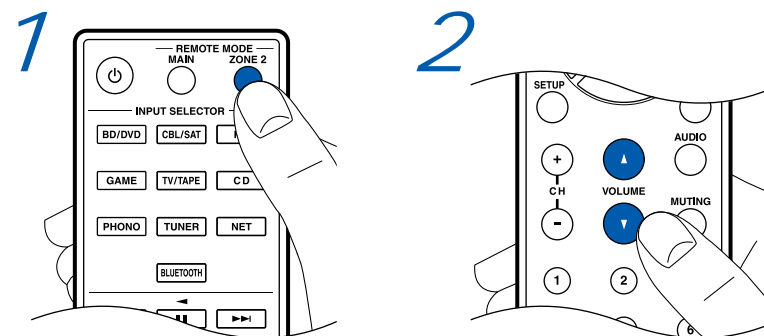

- When connecting an integrated amplifier that does not have a volume control, in the Setup menu, set "Zone 2 Output Level" (→p78) to "Variable". If you do not set this, the volume output will be very loud and there is a danger of damage to the integrated amplifier, speakers, etc.
- To control on the main unit, after pressing the ZONE 2 button on the main unit, turn the VOLUME dial to adjust the volume.



Playing different audio and video

Displaying Your Favorite Video on TV While Playing Music

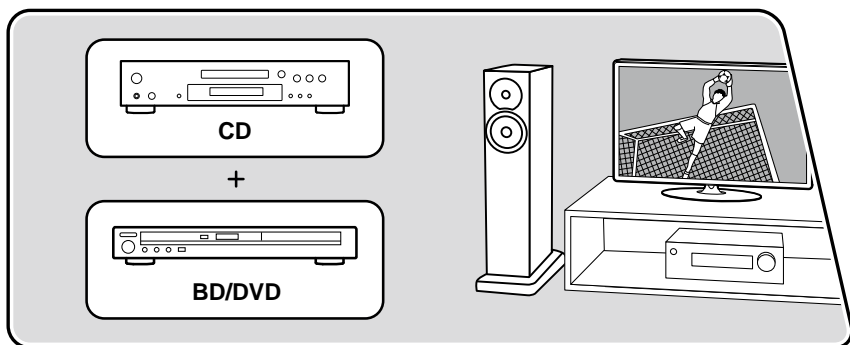

The illustration shows an image.

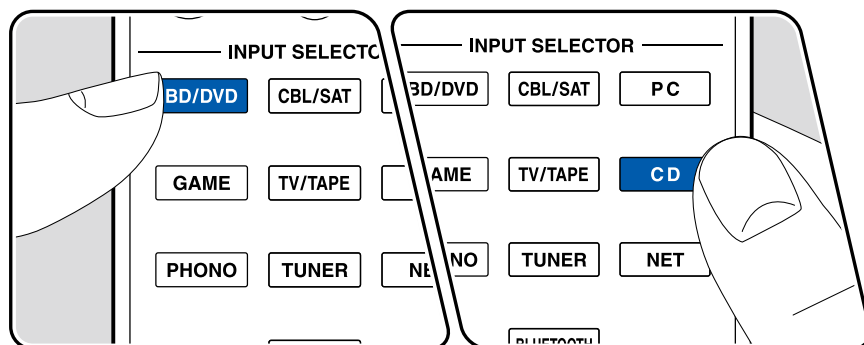

While listening to the music from a CD or Bluetooth enabled device, you can display video on TV from an AV component such as a Blu-ray Disc player.

- For audio playback, you can select an input selector to which video input is not assigned, such as "CD", "PHONO", "TUNER", "NET" and "BLUETOOTH".
- (European, Australian and Asian models): If the "OSD Language" (→p79) is set to Chinese or Japanese, it is not possible to play video while playing the audio from "NET" or "BLUETOOTH".

Perform the following procedure when this unit is on.

1. Switch the input on the TV to the input connected to the unit.
2. Press an input selector such as BD/DVD button connected to the AV component of which the video is to be displayed on TV.
 - This operation is not necessary if the same input selector has been selected in the previous operation.
3. Press an input selector of the audio you want to play, such as the CD or BLUETOOTH button and perform playback operation.
4. Perform the playback operation of the AV component such as a Blu-ray Disc player. To play the audio of NET or Bluetooth, the following step 5 operation is required.
5. To play the audio of NET or Bluetooth, press the CAPS button to switch the TV display from the NET or Bluetooth playback screen to the video of the AV component. Pressing the CAPS button again will return to the NET or Bluetooth playback screen.
 - When the TV display is switched to the video of the AV component, the playback screen of NET or Bluetooth is displayed on the corner of the screen as Mini Player.



Using MY INPUT

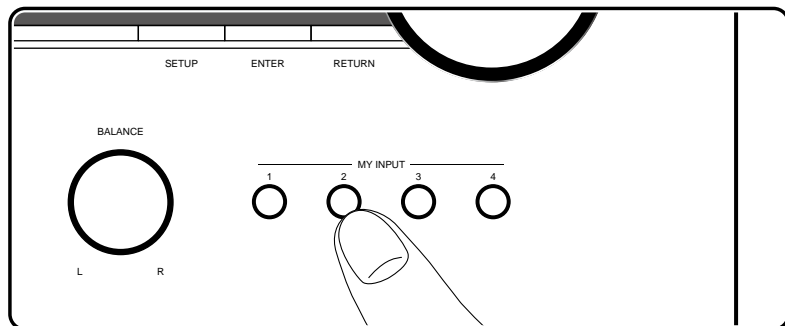

You can register a variety of settings, such as the current input selection or listening mode, in the 4 MY INPUT presets, and then recall these easily. For example: Press the MY INPUT button to automatically switch input to “TUNER” and start receiving the registered station. It also switches to the registered listening mode and volume level.

Regarding the settings that can be registered

- Input selection (It is also possible to register Network services and DAB (European models)/AM (North American models)/FM radio stations.)
- Listening modes
- Volume level (“82” is the upper limit)
- Output destination (Multi Zone)
- TREBLE/BASS/BALANCE, etc.

*If an AM/FM/DAB radio station is registered, the TUNER preset numbers “37”, “38”, “39”, and “40” (→ [p48](#)) are overwritten.

Registering

With the unit in the state you want to register, perform the following procedure:

1. Press and hold one of the MY INPUT buttons 1 to 4.
2. “Preset Written” appears on the display and the settings are registered. Content is overwritten if there was any already registered.

Using the registered settings

1. Press one of the MY INPUT buttons 1 to 4.
 - Even when the main unit is in standby mode, it comes ON when you press the MY INPUT button.



Playing music files saved on a USB storage device

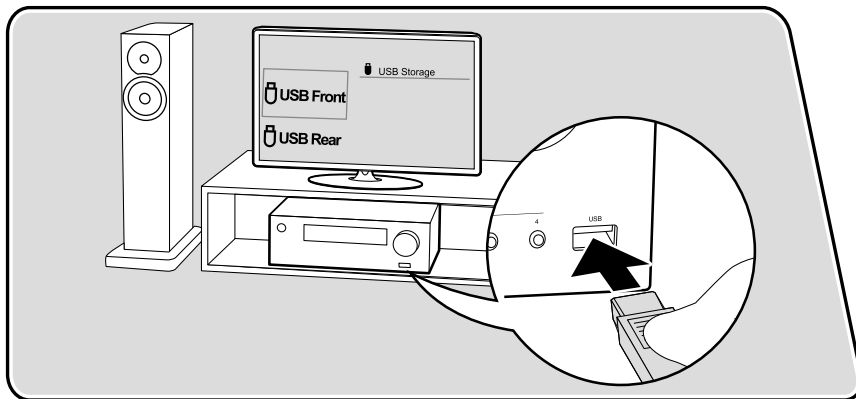

You can play music files stored on a USB storage device.

Onkyo Controller (→[p33](#)) is convenient for controlling the playback of music stored on a USB storage device. It can be used on a smartphone or tablet to which you have downloaded Onkyo Controller (for use on iOS and Android™).



Playing Back

Perform the following procedure when this unit is on.

1. Switch the input on the TV to the input connected to the unit.
2. Plug your USB storage device with the music files into the USB port on the front panel or rear panel of this unit.
3. Press NET to display the network service list screen.
4. Select "USB Front" or "USB Rear" with the cursors, and then press ENTER.
 - If the "USB" indicator blinks on the display, check whether the USB storage device is plugged in properly.
 - Do not unplug the USB storage device while "Connecting..." is being displayed on the display. This may cause data corruption or malfunction.
5. Press ENTER on the next screen again. The list of folders and music files on the USB storage device is displayed. Select the folder with the cursors, and press ENTER to confirm your selection.
6. Select the music file with the cursors, and then press ENTER to start playback.
 - To return to the previous screen, press RETURN.
 - Characters that cannot be displayed on this unit appear with "*".
 - The USB port of this unit complies with the USB 2.0 standard. The transfer speed may be insufficient for some content you play, and sound interruptions, etc. may occur.
 - When playing files recorded with VBR (Variable bit-rate), the playback time may not be displayed correctly.
 - This unit supports the gapless playback of the USB storage device in the following conditions.

When continuously playing WAV, FLAC and Apple Lossless files with the same format, sampling frequency, the number of channels and quantization bit rate.



- To display an album title, artist name and album art of a file in WAV format, make the folder structure and file names as shown below when saving music files. The album art can be displayed by saving a .jpg file to display on the screen in the folder of bottom level. Note that a large volume of .jpg file may take time to be displayed, or may not be displayed.

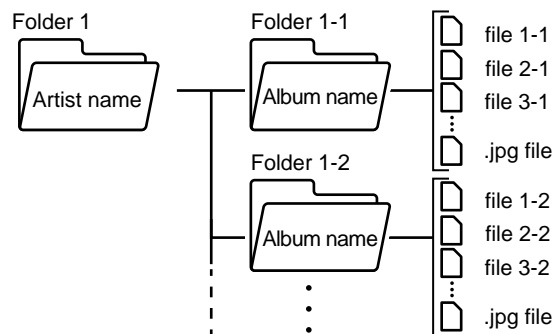

USB Storage Device Requirements

- This unit can use USB storage devices that comply with the USB mass storage class standard. Also the format of USB storage devices supports FAT16 or FAT32 file system format.
- If the USB storage device has been partitioned, each section will be treated as an independent device.
- Up to 20,000 tracks per folder are supported, and folders can be nested up to 16 levels deep.
- USB hubs and USB storage devices with hub functions are not supported. Do not connect these devices to the unit.
- If an AC adapter is supplied with the USB storage device, connect the AC adapter, and use it with a household outlet.
- USB storage devices with security functions are not supported on this unit.
- Media inserted to the USB card reader may not be available in this function. Furthermore, depending on the USB storage device, proper reading of the contents may not be possible.
- In use of a USB storage device, our company accepts no responsibility whatsoever for the loss or modification of data stored on a USB storage device, or malfunction of the USB storage device. We recommend that you back up the data stored on a USB storage device before using it with this unit.
- Note that operation is not always guaranteed for all USB storage devices.



Music Server

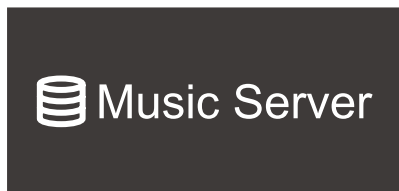

Streaming play of music files stored on PCs or NAS devices connected to the same network as this unit is supported.

Music Server notes

- The network servers this unit is compatible with are those PCs with players installed that have the server functionality of Windows Media® Player 12, or NAS that are compatible with home network functionality. When using Windows Media® Player 12, you need to make the settings beforehand. Note that with PCs, only music files registered in the library of Windows Media® Player can be played.
- When playing files recorded with VBR (Variable bit-rate), the playback time may not be displayed correctly.
- For music files on a server, up to 20,000 tracks per folder are supported, and folders can be nested up to 16 levels deep.
- Depending on the type of media server, the unit may not recognize it, or may not be able to play its music files.
- Onkyo Controller (→ [p33](#)) is convenient for controlling the playback of music stored on a PC or NAS. It can be used on a smartphone or tablet to which you have downloaded Onkyo Controller (for use on iOS and Android™).



Windows Media® Player 12 settings

1. Turn on your PC, and start Windows Media® Player 12.
2. In the "Stream" menu, select "Turn on media streaming" to display a dialog box.
 - If the media streaming is already turned on, select "More streaming options..." in the "Stream" menu to display the list of playback devices in the network, and then go to step 4.
3. Click "Turn on media streaming" to display the list of playback devices in the network.
4. Select this unit in "Media streaming options" and check that it is set to "Allow".
5. Click "OK" to close the dialog.
6. Open the "Stream" menu and confirm that "Allow remote control of my Player..." is checked.
 - Depending on the version of Windows Media® Player, the names of items to select may differ from the above description.

□ Playing Back (→ [p69](#))



Playing Back

Perform the following procedure when this unit is on.

1. Switch the input on the TV to the input connected to the unit.
2. Start the server (Windows Media® Player 12 or NAS device) containing the music files to play.
3. Make sure that the PC or NAS is properly connected to the same network as this unit.
4. Press NET to display the network service list screen.
 - If the "NET" indicator on the display blinks, the unit is not properly connected to the network. Check the connection.

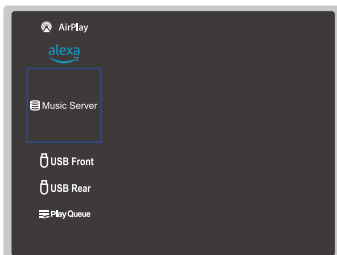

*The screen illustration is an artist's impression

5. With the cursors, select "Music Server", and then press ENTER.

6. Select the target server with the cursors, and press ENTER to display the items list screen.
 - This unit cannot access pictures and videos stored on servers.
 - Depending on the server sharing settings, contents stored on the server may not be displayed.
 7. With the cursors, select the music file to play, and then press ENTER to start playback.
 - If "No Item." is displayed on the screen, check whether the network is properly connected.
- To return to the previous screen, press RETURN.
 - When playing files recorded with VBR (Variable bit-rate), the playback time may not be displayed correctly.
 - For music files on a server, up to 20,000 tracks per folder are supported, and folders can be nested up to 16 levels deep.
 - Depending on the type of media server, the unit may not recognize it, or may not be able to play its music files.

Searching music files to select

If the server you use supports search functions, the following search function can be used.

Perform the following procedure with available servers displayed using Music Server.

1. With \wedge / \vee UP/DOWN, select the server containing music files you want to play, and select ENTER.
2. With \wedge / \vee UP/DOWN, select the Search folder, and press ENTER. The Search folder contains the following three folders.
 - "Search by Artist": Select this when searching by artist name.
 - "Search by Album": Select this when searching by album title.
 - "Search by Track": Select this when searching by track title.
3. With \wedge / \vee UP/DOWN, select the folder, and press ENTER.
4. Input a character string to search for, and press ENTER. Then, the search result is displayed.
5. With \wedge / \vee UP/DOWN, select the music files to play, and select ENTER.



Controlling Remote Playback from a PC

You can use this unit to play music files stored on your PC by operating the PC in your home network. The unit supports remote playback via Windows Media® Player 12. To use the remote playback function of this unit with Windows Media® Player 12, it must be configured beforehand. (→[p68](#))

Remote playback

1. Turn on the power of the unit.
 2. Turn on your PC, and start Windows Media® Player 12.
 3. Select and right-click the music file to play with Windows Media® Player 12.
 - To remotely play a music file on another server, open the target server from "Other Libraries", and select the music file to play.
 4. Select this unit in "Play to" to open the "Play to" window of Windows Media® Player 12, and start playback on this unit.
 - If your PC is running on Windows® 10, click "Cast to Device", and select this unit. Operations during remote playback are possible from the "Play to" window on the PC. The playback screen is displayed on the HDMI-connected TV.
 5. Adjust the volume using the volume bar on the "Play to" window.
 - Sometimes, the volume displayed on the remote playback window may differ from the volume displayed on the display of this unit.
 - When the volume is changed on this unit, the value is not reflected in the "Play to" window.
 - This unit cannot play music files remotely in the following conditions.
 - It is using a network service.
 - It is playing a music file on a USB storage device.
- Remote play of DSD is not supported.
 - Remote playback does not support the gapless playback.



Play Queue



When downloading Onkyo Controller (available on iOS or Android™) to mobile devices, such as a smartphone and tablet, you can save your favorite playlist (Play Queue information) among music files stored in the USB storage device connected to this unit and music files stored in PC or NAS connected to the same network as this unit, and you can play the music on the playlist. The Play Queue information is effective until the power cord of this unit is removed from the outlet. Refer to "1. Install the app" (→p33) for information about the app.

Adding Play Queue Information

1. Select the "INPUT" input on the application screen, and tap the "USB" icon. Or, select the "NET" input, and tap the "USB" icon or "Music Server" icon. (Depending on the model, the icon names may be different.)

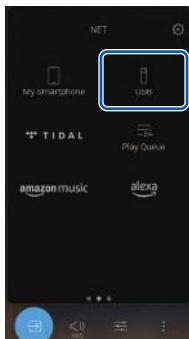

2. Tapping the "+" icon of the track you want to add will open the pop-up to add the Play Queue information.

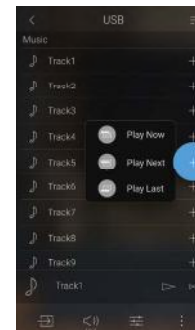

3. Touch the "Play Now" icon, "Play Next" icon or "Play Last" icon to add the track to Play Queue.
 - If there are no tracks on the Play Queue list, only "Play Now" icon is displayed.

Sort and Delete

1. Select the "NET" input, tap the "Play Queue" icon, and enter the Play Queue service screen.

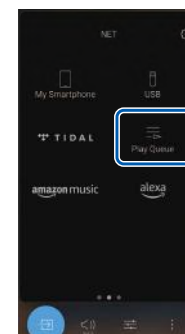

- To reorder the tracks, tap the "✎" editing icon, then tap the "☰" icon of the track and drag it to the destination.

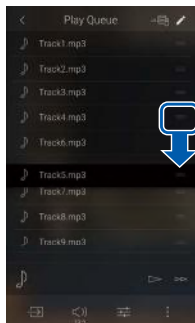

- To delete a track, tap the editing icon "✎" to switch to editing mode.

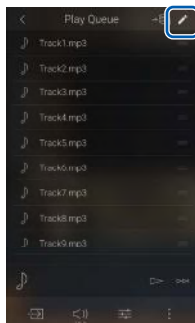

- Tap the "☑" icon next to the track you want to delete to put in a "✓", then when you tap the "☒" icon, the track is deleted from the Play Queue.
 - To select or release all of the tracks, tap the "☑" icon next to Play Queue.

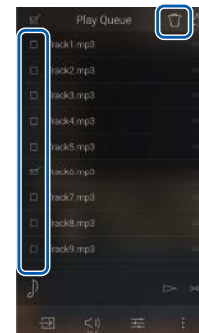

Playing Back

Playback starts when you select "Play Now" for Play Queue addition, or select the track in the Play Queue service screen.



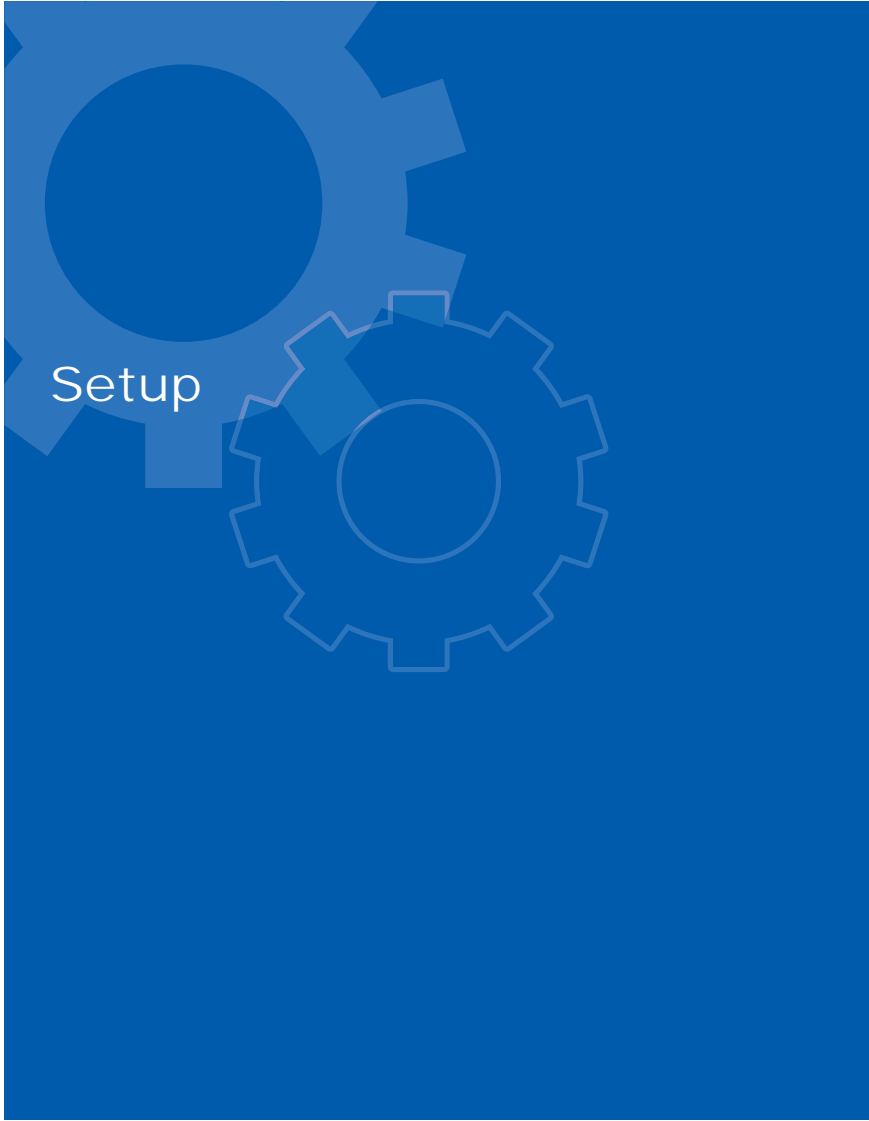

Setup Menu	74
Menu list	74
1. Audio	78
2. Control	79
3. Network	81
4. Bluetooth	84
5. Works with SONOS	86
6. Firmware Update	87
7. Lock	87
8. Factory Reset	88
Web Setup	89



Setup Menu

Press the SETUP button on the remote controller to display the Setup menu.

Select the item with the cursors \wedge / \vee UP/DOWN of the remote controller, and press the ENTER button to confirm your selection.

Use the cursors \leftarrow / \rightarrow LEFT/RIGHT to change the default values.

- To return to the previous screen, press the RETURN button.
- To exit the settings, press the SETUP button.
- If a TV has been connected to the unit using an HDMI cable, you can also use the OSD (On-Screen Display) function which displays screens for operation to make the settings.

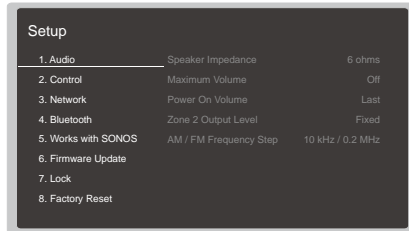

Menu list

	TV screen (OSD)	Main unit display
1. Audio	Speaker Impedance	[1. Audio] [SpImpedance:6Ω] p78
	Maximum Volume	[Max Vol : Off]
	Power On Volume	[POn Vol: Last]
	Zone 2 Output Level	[Z2 Lv : Fixed]
	AM/FM Frequency Step	[AM/FM:10k/0.2M]
	FM Search Level	[FM Lv]: Normal]
	DAB Auto Scan	[DAB Auto Scan]
	DAB DRC	[DAB DRC : Off]



	TV screen (OSD)	Main unit display	
2. Control	OSD Language	[2.Control]	[Lang : English] p79
	HDMI CEC		[HDMI CEC : On]
	HDMI Standby Through		[Thru:Auto(Eco)]
	Auto Standby		[Auto Stby :Off]
	Auto Standby in HDMI Standby Through		[ASb(Thru) :Off]
	Audio Return Channel		[ARC: On]
	Network Standby		[NET Stby : On]
	Bluetooth Wakeup		[Bluetooth :Off]
3. Network	Wi-Fi	[3.Network]	[Wi-Fi :Off] p81
	Wi-Fi Setup		[Wi-Fi Setup]
	Wi-Fi Status		No relevant display
	MAC Address		[MAC Address]
	DHCP		[DHCP : Enable]
	IP Address		[IP Address]
	Subnet Mask		[Subnet Mask]
	Gateway		[Gateway]
	DNS Server		[DNS Server]
	Proxy URL		[Proxy URL]
	Proxy Port		[Proxy Port]
	Friendly Name		[Friendly Name]
	AirPlay		[AirPlay : On]
	AirPlay Device Name		[AirPlay Name]
	AirPlay Password		[AirPlay PW]
	Privacy Statement		[PrvcyStatement]
Network Check		[Network Check]	



	TV screen (OSD)	Main unit display	
4. Bluetooth	Bluetooth Receiver	[4. Bluetooth]	[Rx : On] p84
	Auto Input Change		[AutoChange: On]
	Auto Reconnect		[Reconnect : On]
	Pairing Information		[Pairing Info]
	Device		[Device:]
	Status		[Stat:]
	Bluetooth Transmitter		[Tx :Off]
	Search Devices		[Search Devices]
	Output Level		[OutLv:Variable]
	aptX HD		[aptX HD :Off]
	Low Latency Mode		[LowLatency:Off]
	Pairing Information		[Pairing Info]
	Device		[Device:]
	Staus		[Stat:]
5. Works with SONOS	SONOS-1	[5. Worksw/SONOS]	[Input: Off] p86
	Input Selector		[Connect Device]
	Connected Device		[Out Zone:Main]
	Output Zone		[Preset Volume]
	Preset Volume		
	SONOS-2		[Input: Off]
	Input Selector		[Connect Device]
	Connected Device		[Out Zone:Zone2]
	Output Zone		[Preset Volume]
	Preset Volume		



	TV screen (OSD)	Main unit display	
6. Firmware Update	Update Notice	[6.F/W Update]	[Notice: Enable] p87
	Version		[Ver:xxxx-xxxx-]
	Update via NET		[Update via NET]
	Update via USB		[Update via USB]
7. Lock	Setup Parameter	[7.Lock]	[Setup:Unlocked] p87
8. Factory Reset	Start	[8.FactoryRst]	[ResetSettings?] p88
	Cancel		[ResetSettings?]



1. Audio

Speaker Impedance (Default Value: 6 ohms or above)

Set the impedance (Ω) of the connected speakers.

- For impedance, check the indications on the back of the speakers or their instruction manual.

4ohms	When any of the connected speakers have 4 Ω or more to less than 6 Ω impedance, and expected to be used in Full power continuously.
6 ohms or above	When all the connected speakers have an impedance of 6 Ω or more

Maximum Volume (Default Value: Off)

Set the maximum value to prevent the volume from becoming too loud. Select a value from "Off", and "50" to "99".

Power On Volume (Default Value: Last)

Set the volume level of when the power is turned on. Select a value from "Last" (Volume level before entering standby mode), "Min", "0.5" to "99.5" and "Max".

- You cannot set a higher value than that of "Maximum Volume".

Zone 2 Output Level (Default Value: Fixed)

Select whether to adjust the volume on the integrated amplifier in the separate room or on this unit when outputting to the separate room (Zone 2).

Fixed	Adjust on the integrated amplifier in the separate room
Variable	Adjust on this unit

AM/FM Frequency Step (North American models) (Default Value: 10 kHz / 0.2 MHz)

Select a frequency step to suit your residential area.
Select "10 kHz/0.2 MHz" or "9 kHz/0.05 MHz".

- When this setting is changed, all radio presets are deleted.

FM Search Level (European models) (Default Value: Normal)

If automatic tuning regularly stops on FM stations with weak reception when "Normal" is selected, select "Strong" so only those FM stations with strong reception are selected.

DAB Auto Scan (European models) (Default Value: -)

You can run the auto scan when new DAB stations are added or when you move house.

DAB DRC (European models) (Default Value: Off)

With the DRC (Dynamic Range Control) setting, you can reduce the dynamic range of DAB digital radio so that you can still hear quiet parts even when listening at low volume levels - ideal for listening to the radio late at night when you don't want to disturb anyone.

Off	DRC off
Large	Large reduction in dynamic range
Small	Small reduction in dynamic range



2. Control

□ OSD Language (Default Value: English/Japanese)

Select the on-screen display language from the following.

(North American models)

English, German, French, Spanish, Italian, Dutch, Swedish

(European, Middle East, Australian and Asian models)

English, German, French, Spanish, Italian, Dutch, Swedish, Russian, Chinese
(Japan models)

English, German, French, Spanish, Italian, Dutch, Swedish, Japanese

- Default values vary depending on the regions.

□ HDMI CEC (Default Value: On)

Setting this to "On" enables the input selection link and other link functions with HDMI-connected CEC-compatible device.

When this setting is changed, turn off and then on again the power of all connected devices.

- Depending on the TV to use, a link setting may be required on the TV.
- Setting this to "On" and closing the operation screen will display the name of the connected CEC-compatible device and "CEC On" on the main unit's display.
- When this function is set to "On", the power consumption in standby state increases, however, the increase in power consumption is minimized by automatically entering the HYBRID STANDBY mode where only the essential circuits operate.
- If you operate the VOLUME dial on the main unit when this setting is "On" and audio is output from the TV speakers, audio will be output also from the speakers connected to this unit. To output audio from only either of them, change the setting of this unit or TV, or reduce the volume of this unit.
- If abnormal behavior is observed when this is set to "On", set it to "Off".
- If a connected device is not CEC-compatible, or if you are not sure whether it is compatible, set it to "Off".

On	When this function is used
Off	When this function is not used

□ HDMI Standby Through (Default Value: Auto (Eco))

When this is set to anything other than "Off", you can play the video and audio of an HDMI-connected player on the TV even if the unit is in standby mode. Also, only "Auto" and "Auto (Eco)" can be selected if "HDMI CEC" is set to "On". If you select anything else, set "HDMI CEC" to "Off".

- When this function is set to a value other than "Off", the power consumption in standby state increases, however, the increase in power consumption is minimized by automatically entering the HYBRID STANDBY mode where only the essential circuits operate.
- To play a non-CEC compliant player on the TV, turn the unit on and switch the input.
- When using a CEC-compliant TV, you can reduce the power consumption in standby mode by selecting "Auto (Eco)".

Off	When this function is not used
BD/DVD, GAME, CBL/SAT, PC	For example, if you select "BD/DVD", you can play the equipment connected to the "BD/DVD" jack on the TV even if the unit is in standby mode. Select this setting if you have decided which player to use with this function.
Last	You can play on the TV the video and audio of the input selected immediately before the unit is switched to standby.
Auto, Auto (Eco)	Select one of these settings when you have connected equipment that conforms to the CEC standard. You can play the video and audio of the input selected on the TV, irrespective of what input was selected immediately prior to the unit being switched to standby, using the CEC link function.



2. Control

❑ Auto Standby (Default Value: On/Off)

This setting allows the unit to enter standby mode automatically after 20 minutes of inactivity without any video or audio input.

- Default values vary depending on the regions.

On	The unit will automatically enter standby mode ("AUTO STBY" will light). <ul style="list-style-type: none"> • "Auto Standby" is displayed on the main unit's display and TV screen 30 seconds before entering standby mode.
Off	The unit will not automatically enter standby mode.

❑ Auto Standby in HDMI Standby Through (Default Value: On/Off)

Enable or disable "Auto Standby" while "HDMI Standby Through" is on.

- Default values vary depending on the regions.

On	The setting will be enabled. <ul style="list-style-type: none"> • This setting cannot be set to "On" if "Auto Standby" and "HDMI Standby Through" are set to "Off".
Off	The setting will be disabled.

❑ Audio Return Channel (Default Value: On)

You can enjoy the sound of an HDMI-connected ARC-compatible TV through the speakers connected to the unit.

On	When enjoying the TV sound through the speakers connected to the unit
Off	When the ARC function is not used

❑ Network Standby (Default Value: On)

When this function is set to "On", the network function works even in standby state, and you can turn on the power of the unit via network using an application such as Onkyo Controller that can control this unit.

- When this function is set to "On", the power consumption in standby state increases, however, the increase in power consumption is minimized by automatically entering the HYBRID STANDBY mode where only the essential circuits operate. Note that even if this function is set to "Off", when any of the HDMI CEC (→p79), HDMI Standby Through (→p79) and Bluetooth Wakeup (→p80) functions is enabled, this function will be in "On" state regardless of the setting.
- When connection to the network is lost, "Network Standby" may be disabled to reduce power consumption. In such a case, turn the unit on by using the power button on the remote controller or main unit.

❑ Bluetooth Wakeup (Default Value: Off)

This function wakes up the unit on standby by connecting a Bluetooth enabled device. This is effective when "4. Bluetooth" - "Bluetooth Receiver" is set to "On".

On	When this function is used <ul style="list-style-type: none"> • When this function is set to "On", the power consumption in standby state increases, however, the increase in power consumption is minimized by automatically entering the HYBRID STANDBY mode where only the essential circuits operate.
Off	When this function is not used <ul style="list-style-type: none"> • This setting is fixed to "Off" if "4. Bluetooth" - "Bluetooth Receiver" is set to "Off". • This setting is also fixed to "Off" if "4. Bluetooth" - "Bluetooth Receiver" - "Auto Input Change" is set to "Off".

- Wait for a while if "Network Standby" and "Bluetooth Wakeup" cannot be selected. It can be selected when the network function is activated.



3. Network

Change the settings of the Network function.

- When LAN is configured with a DHCP, set "DHCP" to "Enable" to configure the setting automatically. ("Enable" is set by default) To assign fixed IP addresses to each component, you must set "DHCP" to "Disable", assign an address to this unit in the "IP Address" setting, and set information related to your LAN, such as Subnet Mask and Gateway.

Wi-Fi (Default Value: Off(Wired))

Connect the unit to the network via a wireless LAN router.

- When switching between "On" and "Off(Wired)", stop the Network service. Also, when group playback is in process, cancel the group playback once, and then switch the setting.

On	Wireless LAN connection
Off(Wired)	Wired LAN connection

Wi-Fi Setup (Default Value: -)

Configure wireless LAN settings by pressing ENTER with "Start" displayed.

Wi-Fi Status (Default Value: -)

The information of the connected access point is displayed.

SSID	SSID of the connected access point.
Signal	Signal strength of the connected access point.
Status	Status of the connected access point.

MAC Address (Default Value: -)

Check the MAC address of this unit.

This value is specific to the component and cannot be changed.

DHCP (Default Value: Enable)

Enable	Auto configuration by DHCP
Disable	Manual configuration without DHCP <ul style="list-style-type: none"> If you select "Disable", set "IP Address", "Subnet Mask", "Gateway", and "DNS Server" manually.

IP Address (Default Value: 0.0.0.0)

Displays/Sets the IP address.

Subnet Mask (Default Value: 0.0.0.0)

Displays/Sets the subnet mask.

Gateway (Default Value: 0.0.0.0)

Displays/Sets the gateway.

DNS Server (Default Value: 0.0.0.0)

Displays/Sets the primary DNS server.

Proxy URL (Default Value: -)

Displays/Sets the proxy server URL.

Proxy Port (Default Value: 8080)

Displays/Sets the proxy server port number when you input "Proxy URL".



3. Network

□ Friendly Name (Default Value: Onkyo TX-8470 XXXXXX)

Change the model name of this unit which is displayed on the device connected to the network to an easily recognized name.

1. Press ENTER to display the Edit screen.
2. Select a character or symbol with the cursors, and press ENTER.
Repeat this operation to input up to 31 characters.
"A/a": Switches between upper and lower cases.
"←" "→": Moves the cursor in the arrow direction.
"⌫": Removes a character on the left of the cursor.
"␣": Enters a space.
• Pressing CLR on the remote controller will remove all the input characters.
3. After inputting, select "OK" with the cursors, and press ENTER.
The input name will be saved.

□ AirPlay (Default Value: On)

Select whether or not to use the AirPlay function.

On	When this function is used
Off	When this function is not used

□ AirPlay Device Name (Default Value: Onkyo TX-8470 XXXXXX)

Change the model name of this unit which is displayed on the AirPlay-connected device to an easily recognized name.

1. Press ENTER to display the Edit screen.
2. Select a character or symbol with the cursors, and press ENTER.
Repeat this operation to input up to 31 characters.
"A/a": Switches between upper and lower cases.
"←" "→": Moves the cursor in the arrow direction.
"⌫": Removes a character on the left of the cursor.
"␣": Enters a space.
• Pressing CLR on the remote controller will remove all the input characters.
3. After inputting, select "OK" with the cursors, and press ENTER.
The input name will be saved.
• This function cannot be used when registering this unit to Home App.



3. Network

❑ AirPlay Password (Default Value: -)

You can set a password of up to 31 characters so that only users that have input can use AirPlay.

1. Press ENTER to display the Edit screen.
2. Select a character or symbol with the cursors, and press ENTER.
Repeat this operation to input up to 31 characters.
 - "A/a": Switches between upper and lower cases.
 - "←" "→": Moves the cursor in the arrow direction.
 - "⊞": Removes a character on the left of the cursor.
 - "␣": Enters a space.
 - To select whether to mask the password with "*" or display it in plain text, press MENU on the remote controller.
 - Pressing CLR on the remote controller will remove all the input characters.
3. After inputting, select "OK" with the cursors, and press ENTER.
The input password will be saved.
 - This function cannot be used when registering this unit to Home App.

❑ Privacy Statement (Default Value: Not Accepted)

When using a network service that requires a login name, email address, password, etc., you need to agree to the Privacy Statement of our company.

- This setting can be made after confirming the Privacy Statement.
- When "Not Accepted" is selected, the login name, email address, password, etc., that are kept on this unit will be deleted and you will be logged out from the network service you have logged in.

❑ Network Check (Default Value: -)

You can check the network connection.
Press ENTER when "Start" is displayed.

- Wait for a while if "3. Network" cannot be selected. It can be selected when the network function is activated.



4. Bluetooth

Change the settings for the Bluetooth function.

- Wait for a while if "4. Bluetooth" cannot be selected. It can be selected when the Bluetooth function is activated.

(Bluetooth Receiver)

❑ Bluetooth Receiver (Default Value: On)

Select whether or not to use the function that receives audio from Bluetooth wireless technology enabled devices.

On	When this function is used
Off	When this function is not used

❑ Auto Input Change (Default Value: On)

When a Bluetooth enabled device is played while it is connected to the unit, the input of the unit can be automatically switched to "BLUETOOTH".

On	The input will automatically become "BLUETOOTH" when a Bluetooth enabled device is connected.
Off	The function is disabled. <ul style="list-style-type: none"> • If the input is not switched automatically, set this to "Off", and change the input manually.

❑ Auto Reconnect (Default Value: On)

This function automatically reconnects to the Bluetooth enabled device connected last when you change the input to "BLUETOOTH".

- This may not work with some Bluetooth enabled devices.

On	When this function is used
Off	When this function is not used

❑ Pairing Information (Default Value: -)

You can initialize the pairing information stored on this unit. If you are no longer able to connect with a device you have paired, try doing this. (→p97)

Pressing ENTER when "Clear" is displayed initializes the pairing information stored on this unit.

- This function does not initialize the pairing information on the Bluetooth enabled device. When pairing the unit again with the device, be sure to clear the pairing information on the Bluetooth enabled device beforehand. For information on how to clear the pairing information, refer to the instruction manual of the Bluetooth enabled device.

❑ Device (Default Value: -)

Displays the name of the Bluetooth enabled device connected to the unit.

- The name is not displayed when "Status" is "Ready" and "Pairing".

❑ Status (Default Value: -)

Displays the status of the Bluetooth enabled device connected to the unit.

Ready	Not paired
Pairing	Paired
Connected	Successfully connected



4. Bluetooth

(Bluetooth Transmitter)

Bluetooth Transmitter (Default Value: Off)

Select whether or not to use the function that transmits audio from this unit to Bluetooth wireless technology enabled devices.

On (Tx)	When this function is to be used (played back only on Bluetooth wireless technology enabled devices)
On (Main + Tx)	When this function is to be used (played back both on this unit and on Bluetooth wireless technology enabled devices)
Off	When this function is not used

Search Devices (Default Value: -)

Search for a Bluetooth wireless technology enabled device that is able to receive the audio from this unit. Select "Start" then press ENTER. A list of the names of Bluetooth wireless technology enabled devices that are able to receive is displayed. Select the device to be connected with the cursors \wedge / \vee UP/DOWN, then pairing begins when you press ENTER.

Output Level (Default Value: Variable)

You can select whether to adjust the volume on this unit or to adjust it on the Bluetooth wireless technology enabled device.

Variable	To use the volume controls on this unit
Fixed	To use the volume controls on the Bluetooth wireless technology enabled device

aptX HD (Default Value: Off)

It is possible to use aptX HD to connect a Bluetooth wireless technology enabled device and this unit.

- The codec of the receiving device must be compatible with aptX HD.

On	When this function is used
Off	When this function is not used

Low Latency Mode (Default Value: Off)

If the audio from a device connected via Bluetooth is delayed compared to the video on the TV when watching a gaming screen, etc., you can reduce the audio delay.

On	When this function is used
Off	When this function is not used

Pairing Information (Default Value: -)

You can initialize the pairing information stored on this unit. If you are no longer able to connect with a device you have paired, try doing this. (→p97)

Pressing ENTER when "Clear" is displayed initializes the pairing information stored on this unit.

- This function does not initialize the pairing information on the Bluetooth enabled device. When pairing the unit again with the device, be sure to clear the pairing information on the Bluetooth enabled device in advance. For information on how to clear the pairing information, refer to the Bluetooth enabled device's instruction manual.

Device (Default Value: -)

Displays the name of the Bluetooth enabled device connected to the unit.

- The name is not displayed when "Status" is "Ready" and "Pairing".

Status (Default Value: -)

Displays the status of the Bluetooth enabled device connected to the unit.

Ready	Not paired
Pairing	Paired
Connected	Successfully connected
Connected (aptX)	Successfully connected with aptX compatible device
Connected (aptX HD)	Successfully connected with aptX HD compatible device



5. Works with SONOS

Change the settings to connect with the Sonos Port.

(SONOS-1/SONOS-2)

Input Selector (Default Value: Off)

Select the input selector to which the Sonos Port is connected.

- Selecting "Off" disables the interlock function with Sonos.

Connected Device (Default Value: -)

Displays the Sonos Port connected to the same network as the network of this unit. Press the ENTER button to select the connected Sonos Port.

- Products (e.g. Play:3 unequipped with an output terminal) other than the Sonos Port are also displayed in the device list and selectable. In that case, when playback on the Sonos side starts, the input is switched, however, audio is not output. Select the room name of the connected Sonos Port.
- Up to 32 devices can be displayed on the Sonos product list screen. If you cannot find the Sonos Port to be interlocked, return to the previous screen, turn off the product you do not want to interlock, and try again.
- To use this function, set "Input Selector" beforehand.

Output Zone (Default Value: Main)

Select the zone where you want to listen to the music.

- To use this function, set "Input Selector" beforehand.

Main	Outputs audio only to the main room (where this unit is located).
Zone 2	Outputs audio only to the separate room (ZONE 2).
Main/Zone 2	Outputs audio to both the main room and separate room (ZONE 2).

Preset Volume (Default Value: Main=Last / Zone 2=Last)

You can set the volume beforehand for playing back the Sonos Port. You can set volumes for the main room (where this unit is located) and separate room (ZONE 2) respectively. Select a value from "Last" (Volume level before entering standby mode), "Min", "0.5" to "99.5" and "Max".

- To use this function, set "Input Selector" beforehand.



6. Firmware Update

Update Notice (Default Value: Enable)

Availability of a firmware update is notified via network.

Enable	Notify updates
Disable	Do not notify updates

Version (Default Value: -)

The current firmware version is displayed.

Update via NET (Default Value: -)

Press ENTER to select when updating the firmware via network.

- This setting cannot be selected if you do not have Internet access or there is no updatable firmware.

Update via USB (Default Value: -)

Press ENTER to select when updating the firmware via USB.

- This setting cannot be selected if a USB storage device is not connected or there is no updatable firmware in the USB storage device.
- Wait for a while if "6. Firmware Update" cannot be selected. It can be selected when the network function is activated.

7. Lock

Lock the Setup menu so that the settings cannot be changed.

Setup Parameter (Default Value: Unlocked)

Lock the Setup menu so that the settings cannot be changed.

Locked	The menu is locked.
Unlocked	The menu is unlocked.



8. Factory Reset

All the settings are restored to factory defaults.
Select "Start" and press ENTER.

- If "Factory Reset" is performed, your settings are restored to the default values. Be sure to note down your setting contents beforehand.



Web Setup

Menu operations

You can make the settings for the network function of this unit using an Internet browser on a PC, smartphone, etc.

1. Press **SETUP** on the remote controller to display the Setup menu.
2. Select "3. Network" with the cursors, and then take a note of the IP address displayed in "IP Address".
3. Start the Internet browser on your PC, smartphone, etc. and enter the IP address of this unit in the URL field.
4. The screen for entering the user name and password is displayed. Enter the following then click "OK".
User name: admin (fixed)
Password: admin (default value)
 - Input is required again if you close the browser.
5. Change the password.
 - Take a note of the password so that you do not forget it. If you do forget it, reset the unit (→ [p92](#)) then log in again with the initial settings (admin).
6. Information for the unit (Web Setup screen) is displayed in the internet browser.



7. After changing the settings, select "Save" to save the settings.

Device Information

You can change the Friendly Name or AirPlay Device Name, set an AirPlay Password, etc.

Control4: Register this unit if you are using a Control4 system.

Firmware Update: Select the firmware file you have downloaded to your PC so you can update this unit.

Network Setting

Status: You can see information for the network such as the MAC address and IP address of this unit.

Network Connection: You can select a network connection method. If you select "Wireless", select an access point from "Wi-Fi Setup" to connect.

DHCP: You can change DHCP settings. If you select "Off", set "IP Address", "Subnet Mask", "Gateway" and "DNS Server" manually.

Proxy: Display and set the URL for the proxy server.



Troubleshooting

Before starting the procedure	91
When the unit is operating erratically	92
Try restarting the unit	92
Resetting the unit (this resets the unit settings to the default)	92
Turning off Initial Setup which appears when you turn the power on	93
Troubleshooting	94
■ Power	94
■ Audio	94
■ Video	95
■ Linked operation	96
■ Tuner (North American and European models)	96
■ Bluetooth function	96
■ Network function	98
■ USB storage device	99
■ Wireless LAN Network	99
■ Multi-zone function	100
■ Remote Controller	100
■ Display	100
■ Others	100



Before starting the procedure

Problems may be solved by simply turning the power on/off or disconnecting/connecting the power cord, which is easier than working on the connection, setting and operating procedure. Try the simple measures on both the unit and the connected device. If the problem is that the video or audio is not output or the HDMI linked operation does not work, disconnecting/connecting the HDMI cable may solve it. When reconnecting, be careful not to wind the HDMI cable since if wound the HDMI cable may not fit well. After reconnecting, turn off and on the unit and the connected device.

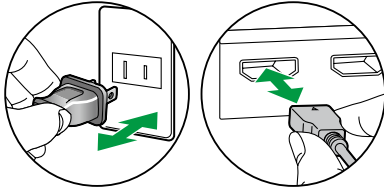

- The AV receiver contains a microPC for signal processing and control functions. In very rare situations, severe interference, noise from an external source, or static electricity may cause it to lockup. In the unlikely event that this happens, unplug the power cord from the wall outlet, wait at least 5 seconds, and then plug it back in.
- Our company is not responsible for damages (such as CD rental fees) due to unsuccessful recordings caused by the unit's malfunction. Before you record important data, make sure that the material will be recorded correctly.



When the unit is operating erratically

❑ Try restarting the unit

Restarting this unit may solve the problem. Set the main unit to standby, then after waiting for 5 seconds or more, press and hold the  ON/STANDBY button of the main unit for at least 5 seconds, and then restart the unit. (The settings on this unit are kept.) If the problem persists after restarting the unit, unplug and plug the power cords or HDMI cable of this unit and connected devices.

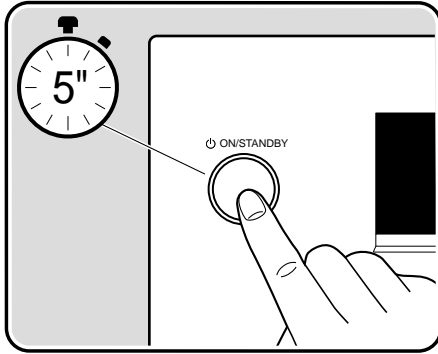

❑ Resetting the unit (this resets the unit settings to the default)

If the restart of the unit does not solve the problem, reset the unit, and restore all the settings to the factory default at the time of purchase. This may solve the problem. If the unit is reset, your settings are restored to the default values. Be sure to note down your setting contents before performing the following operations. Note that it is not possible to reset the unit during the Initial Setup process. Before doing the following procedures, press RETURN to exit Initial Setup.

1. While pressing and holding ZONE 2 button on the main unit with the unit turned on, press the  ON/STANDBY button.
2. "Clear" is displayed on the display, and the unit returns to the standby state. Do not remove the power cord until "Clear" disappears from the display.

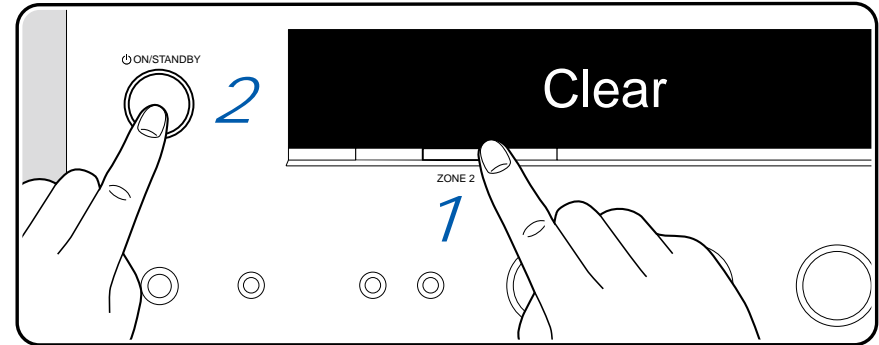

Turning off Initial Setup which appears when you turn the power on

If a Wi-Fi connection is not established, or if a wired LAN connection is not made, Initial Setup is displayed when you turn the power on.

To stop Initial Setup from being displayed, press and hold the RETURN button for 5 or more seconds while it is being displayed.

- You will need to initialize (→ [p92](#)) to restore this setting, so be sure that you want to proceed.



Troubleshooting

■ Power

❑ The unit turns off unexpectedly

- If "2. Control" - "Auto Standby" on the Setup menu is activated, the unit automatically enters the standby mode. (→p80)
- The protection circuit function may have operated due to an abnormal rise in temperature of the unit. In such a case, the power turns off repeatedly even if the power is turned on each time. Secure sufficient ventilation space around the unit, wait for a while until the temperature of the unit decreases. Then, turn the power on again.

WARNING: If smoke, smell or abnormal noise is produced by the unit, unplug the power cord from the outlet immediately, and contact the dealer or our company's support.

■ Audio

- Confirm that the connection between the output jack on the connected device and the input jack on this unit is correct.
- Make sure that none of the connecting cables are bent, twisted, or damaged.
- If "MUTING" is displayed on the display and MUTE is blinking, press the MUTING button on the remote controller to cancel muting.
- While headphones are connected to the PHONES jack, no sound is output from the speakers.

Check the following if the problem persists after you have confirmed the above.

❑ No sound from the TV

- Change the input selector on this unit to the position of the terminal to which the TV is connected.
- If the TV doesn't support the ARC function, along with connection by HDMI, connect the TV and this unit using a digital optical cable or analog audio cable. (→p24)

❑ No sound from a connected player

- Change the input selector on this unit to the position of the jack to which the player is connected.
- Check the digital audio output setting on the connected device. On some game consoles, such as those supporting DVD, the default setting may be off.
- For some DVD-Video discs, you need to select an audio output format from a menu.

❑ Speakers produce no sounds

- Make sure that the polarity (+/-) of the speaker cables is correct, and that no bare wires are in contact with the metal part of speaker terminals. (→p18)
- Make sure that the speaker cables are not shorting out.
- Check "Connect the Speaker Cables" (→p18) to see if the speaker connections have been made correctly.



❑ Noise can be heard

- Using cable ties to bundle analog audio cables, power cords, speaker cables, etc. may degrade the audio performance. Do not bundle the cords.
- An audio cable may be picking up interference. Change the position of the cables.

❑ The beginning of audio received by an HDMI IN cannot be heard

- Since it takes longer to identify the format of an HDMI signal than it does for other digital audio signals, audio output may not start immediately.

❑ Sound suddenly reduces

- When using the unit for extended periods with the temperature inside the unit exceeding a certain temperature, the volume may be reduced automatically to protect the circuits.

■ Video

- Confirm that the connection between the output jack on the connected device and the input jack on this unit is correct.
- Make sure that none of the connecting cables are bent, twisted, or damaged.
- When the TV image is blurry or unclear, the power cord or connection cables of the unit may have interfered. In such a case, keep distance between TV antenna cable and cables of the unit.
- Check the switching of the input screen on the monitor side such as a TV.

Check the following if the problem persists after you have confirmed the above.

❑ No image appears

- Change the input selector on this unit to the position of the jack to which the player is connected.

❑ No image from a device connected to HDMI IN jack

- To display video from the connected player on the TV while the unit is in standby, you need to enable "2. Control" - "HDMI Standby Through" on the Setup menu. (→p79)
- Check if "Resolution Error" is displayed on the main unit display when video input via HDMI IN jack is not displayed. In this case, the TV does not support the resolution of the video input from the player. Change the setting on the player.
- Normal operation with an HDMI-DVI adapter is not guaranteed. In addition, video signals output from a PC are not guaranteed.
- Try switching off the Deep Color function. To turn off the Deep Color function, simultaneously press the ZONE2 OFF and ENTER buttons on the main unit. While holding down ZONE2 OFF, press ENTER repeatedly until "Deep Color:Off" appears on the display. To reactivate the Deep Color function, repeat the above described step until "Deep Color:On" is appeared on the display.

❑ Images flicker

- The output resolution of the player may not be compatible with the resolution of the TV. If the player is connected to this unit with an HDMI cable, change the output resolution on the player. Also this may be solved by changing the screen mode on the TV.



■ Linked operation

❑ HDMI linked operation does not work with CEC-compliant devices, such as a TV

- In the Setup menu of the unit, set "2. Control" - "HDMI CEC" to "On".
- It is also necessary to set HDMI linking on the CEC-compliant device. Check the instruction manual.

(→p79)

■ Tuner (North American and European models)

❑ Poor reception or much noise

- Recheck the antenna connection.
- Move the antenna away from the speaker cord or power cord.
- Move the unit away from your TV or PC.
- Passing cars or airplanes in the vicinity can cause interference.
- If radio waves are blocked by concrete walls, etc., radio reception may be poor.
- Change the reception mode to mono (→p44).
- When listening to an AM station, operating the remote controller may cause noise.
- FM reception may be clearer if you use the antenna jack on the wall used for the TV.

(→p29)

■ Bluetooth function

- Unplug and plug the power cord of the unit, or turn off and on the Bluetooth enabled device. Restart of the Bluetooth enabled device may be effective.
- Bluetooth enabled devices must support the A2DP profile.
- Because a radio wave interference will occur, this unit may not be used near devices such as a microwave oven or cordless phone which use the radio wave in the 2.4 GHz range.
- A metallic object near the unit can affect on the radio wave, and Bluetooth connection may not be possible.

Check the following if the problem persists after you have confirmed the above.

❑ Cannot transmit from a Bluetooth wireless technology enabled device (PC, smartphone, etc.) to this unit

- Check if the Bluetooth function of the Bluetooth enabled device is enabled.



❑ Cannot connect a Bluetooth wireless technology enabled device (PC, smartphone, etc.) to this unit

- Initialize the pairing information and perform pairing again.
 Firstly delete all the pairing information saved on this unit. In the Setup menu, select "4. Bluetooth" - "Bluetooth Receiver" - "Pairing Information", then press ENTER while "Clear" is displayed.
 Next, delete the pairing information of this unit that is saved on the Bluetooth wireless technology enabled device. For information on how to clear the pairing information, refer to the Bluetooth enabled device's instruction manual.
 Finally, perform pairing again. Refer to "Playing audio from Bluetooth wireless technology enabled devices with this unit" (→[p40](#)) for pairing instructions.

❑ Cannot transmit from this unit to a Bluetooth wireless technology enabled device (wireless headphones, etc.)

- Check that the "Bluetooth Transmitter" setting on this unit is set to either "On(Tx)" or "On(Main + Tx)".

❑ Cannot connect this unit to a Bluetooth wireless technology enabled device (wireless headphones, etc.)

- Check if the Bluetooth function of the Bluetooth enabled device is enabled.
- Initialize the pairing information and perform pairing again.
 Firstly delete all the pairing information saved on this unit. In the Setup menu, select "4. Bluetooth" - "Bluetooth Transmitter" - "Pairing Information", then press ENTER while "Clear" is displayed.
 Next, delete the pairing information of this unit that is saved on the Bluetooth wireless technology enabled device. For information on how to clear the pairing information, refer to the Bluetooth enabled device's instruction manual.
 Finally, perform pairing again. Refer to "Transmitting audio from this unit to Bluetooth wireless technology enabled devices" (→[p42](#)) for pairing instructions.

❑ Music playback is unavailable on the unit even after successful Bluetooth connection

- If the volume setting on this unit or the Bluetooth wireless technology enabled device is low, audio may not be played. Check the volume setting on this unit or the Bluetooth wireless technology enabled device.
- Some Bluetooth enabled devices may be equipped with a Send/Receive selector switch. Try switching the setting to suit the application the device is being used for.
- Depending on the characteristics or specifications of the Bluetooth enabled device, music may not be played back on this unit.

❑ Sound is interrupted

- There maybe a problem with the Bluetooth enabled device. Check the information on a web page.

❑ The audio quality is poor after connection with a Bluetooth enabled device

- The Bluetooth reception is poor. Move the Bluetooth enabled device closer to the unit, or remove any obstacle between the Bluetooth enabled device and this unit.



■ Network function

- If you cannot select a network service, start up the network function to select it. It may take approx. one minute to start it up.
- When the NET indicator is blinking, this unit is not properly connected to the home network.
- Unplug and plug the power cords of this unit and the router, or restart the router.
- If the desired router is not displayed in the access point list, it may be set to hide SSID, or the ANY connection may be off. Change the setting and try again.

Check the following if the problem persists after you have confirmed the above.

□ Cannot access the Internet radio

- In the case the service provider has terminated the service, the network service or contents may not be used on this unit.
- Check if your modem and router are properly connected, and they are both turned on.
- Check if the LAN side port on the router is properly connected to this unit.
- Check if connecting to Internet from other devices is possible. If it is not possible, turn off all devices connected to the network, wait for a while, and then turn on the devices again.
- Depending on ISP, setting the proxy server is required.
- Check if the router and modem you are using are supported by your ISP.

□ Cannot access the network server

- This unit needs to be connected to the same router as the network server.
- This unit supports the Windows Media® Player 12 network servers, or NASes that support the home network function.
- Windows Media® Player may require some settings. Refer to "Music Server".
- When using a PC, only the music files registered in the library of Windows Media® Player can be played.

(→p68)

□ Sound is interrupted when playing music files on the network server

- Check if the network server meets the requirements for operation.
- When the PC is serving as the network server, quit application software other than the server software (Windows Media® Player 12, etc.).
- If the PC is downloading or copying large files, the playback sound may be interrupted.



■ USB storage device

❑ USB storage device is not displayed

- Check if the USB storage device or USB cable is securely inserted to the USB port of the unit.
- Disconnect the USB storage device once from the unit, and then reconnect it.
- Performance of the hard disk that receive power from the USB port of the unit is not guaranteed.
- Depending on the type of content, the playback may not be performed normally. Check the types of supported file formats.
- Operations of USB storage devices equipped with security functions are not guaranteed.

(→p66)

■ Wireless LAN Network

- Unplug and plug the power cords of this unit and the wireless LAN router, check the power-on status of the wireless LAN router, or restart the wireless LAN router.

Check the following if the problem persists after you have confirmed the above.

❑ Cannot access wireless LAN network

- The wireless LAN router setting may be switched to Manual. Restore the setting to Auto.
- Try the manual set-up. The connection may succeed.
- When the wireless LAN router is in stealth mode (mode to hide SSID) or when the ANY connection is off, the SSID is not displayed. Change the setting and try again.
- Check if the SSID and encryption settings are correct. Match the network settings with the settings of this unit.
- Connection to an SSID that includes multi-byte characters is not supported. Set the SSID of the wireless LAN router using single-byte alphanumeric characters only, and try again.

❑ Connected to an SSID different from the selected SSID

- Some wireless LAN routers allow you to set multiple SSIDs for one unit. If connecting to such a router using the automatic setting button, you may end up connecting to an SSID different from the SSID you want to connect to. If this occurs, use the connection method requiring you to enter a password.

❑ Playback sound is interrupted, or communication is not possible

- You may not receive radio waves due to poor radio wave conditions. Shorten the distance from the wireless LAN router, or remove obstacles to improve visibility, and connect again. Install the unit away from microwave ovens or other access points. It is recommended to install the wireless LAN router and the unit in the same room.
- If there is a metallic object near the unit, wireless LAN connection may not be possible because the metal affects the radio wave.
- When other wireless LAN devices are used near the unit, other symptoms may occur, such as interrupted playback and impossible communication. You can avoid those problems by changing the channel of your wireless LAN router. For instructions on changing channels, refer to the instruction manual supplied with your wireless LAN router.
- There may not be enough bandwidth available in wireless LAN. Use a wired LAN for connection.



■ Multi-zone function

❑ Cannot ZONE-output the audio of externally connected AV components

- To output audio from an externally connected AV component to ZONE 2, use an analog audio cable for connection. Note that ZONE 2 output is not possible with the connection using an HDMI cable, digital coaxial cable, or digital optical cable.

❑ Others

- If the audio signal is from the NET input selector, the zone output is not possible for DSD audio signals.

■ Remote Controller

- Make sure that the batteries are inserted with the correct polarity.
- Insert new batteries. Do not mix different types of batteries, or old and new batteries.
- Make sure that the sensor of the main unit is not subjected to direct sunlight or inverter-type fluorescent lights. Relocate it if necessary.
- If the main unit is installed in a rack or cabinet with colored-glass doors, or if the doors are closed, the remote controller may not work normally.

■ Display

❑ The display does not light up

- When the Dimmer function is working, the display may go dim. Press the DIMMER button, and change the brightness level of the display.
- The display is turned off when the Pure Audio listening mode is selected.

(→[p10, 15](#))

(→[p10](#))

■ Others

❑ Strange noise can be heard from the unit

- If you have connected another device to the same outlet as this unit, strange noise may occur under the influence of the device. If the symptom is remedied by removing the power plug of the other device from the outlet, use different outlets for this unit and the device.



Appendix



General Specifications

Amplifier Section	North American and Japanese models	European, Middle East, Australian and Asian models
Rated Output Power *	<p>(North American models) With 8 ohm loads, both channels driven, from 20Hz-20kHz; rated 110 watts per channel minimum RMS power, with no more than 0.08% total harmonic distortion from 250 milliwatts to rated output.</p> <p>(Japanese models) 2 ch x 110 W at 8ohms, 20-20,000Hz, 2ch driven of 0.08% THD (JEITA) 2 ch x 150 W at 6 ohms, 1 kHz, 2 ch driven of 0.7% THD (JEITA)</p>	2 ch x 140 W at 4 or 6 ohms, 1 kHz, 2 ch driven of 1% THD 2 ch x 120 W at 8 ohms, 1 kHz, 2 ch driven of 1% THD
Maximum Effective Output Power *	<p>(North American models) 210 W at 6 ohms, 1 kHz, 2 ch driven of 10% THD</p> <p>(Japanese models) 2 ch x 190 W at 6 ohms, 1 kHz, 2 ch driven of 10% THD</p>	2 ch x 170 W at 6 ohms, 1 kHz, 2 ch driven of 10% THD (JEITA)
THD+N (Total Harmonic Distortion + Noise)	0.08% (20 Hz - 20,000 Hz, Rated output power)	
Input Sensitivity and Impedance	200 mV/32 k Ω (LINE(RCA)), 4 mV/47 k Ω (PHONO MM), 0.4 mV/110 Ω (PHONO MC)	
Rated RCA Output Level and Impedance	PRE OUT : 1 V/470 Ω	
	LINE OUT : 200 mV/470 Ω	
Phono Maximum Input Signal Voltage	70 mV (MM 1 kHz 0.5%), 7 mV (MC 1 kHz 0.5%)	
Frequency Response	5 Hz - 100 kHz/+1 dB, -3 dB (DIRECT/Pure Audio)	
Tone Control Characteristics	\pm 10 dB, 100 Hz (Bass), \pm 10 dB, 10 kHz (Treble)	
Signal to Noise Ratio	106 dB (IHF-A, LINE IN, SP OUT), 76 dB (IHF-A, PHONO MM 5mV IN, SP OUT), 60 dB (IHF-A, PHONO MC 0.5mV IN, SP OUT)	
Supported impedance of Speakers	4 Ω - 16 Ω	



Headphone Rated Output	80 mW + 80 mW (32 Ω, 1 kHz, 10% THD)
Supported impedance of Headphones	8 Ω - 600 Ω
Headphones Frequency Response	5 Hz - 100 kHz (Direct/Pure Audio)

*Typical usage is 1/8th power (Sine wave) on 2ch channels into the rated load. Full power is expected to be used in extreme case for a while.

Tuner Section	North American models	European models
FM Tuning Frequency Range	87.5 MHz - 107.9 MHz	87.5 MHz - 108.0 MHz, RDS
50 dB quieting sensitivity (FM MONO)	2.8 μV, 20.2 dBf (IHF, 1 kHz, 100% MOD)	
AM Tuning Frequency Range	530 kHz - 1710 kHz	-
DAB Tuning Frequency Range	-	174.928 MHz - 239.200 MHz (Band III)
DAB Sensitivity	-	-100 dBm (Min.) (Band III)
Preset Channel	40	

Bluetooth Section	North American and Japanese models	European, Middle East, Australian and Asian models
Communication system	Bluetooth Specification version 4.2	
Frequency band	2.4GHz (2.402-2.480GHz)	
Modulation method	FHSS (Frequency Hopping Spread Spectrum)	
Compatible Bluetooth profiles	A2DP 1.3.1, AVCTP 1.4, AVDTP 1.3, AVRCP 1.6.1	
Supported Codecs	Receiving: SBC, AAC Transmitting: SBC, aptX, aptX HD	
Transmission range (A2DP)	20 Hz - 20 kHz (Sampling frequency 44.1 kHz)	
Maximum communication range	Line of sight approx. 15 m(*) (*)The actual range will vary depending on factors such as obstacles between devices, magnetic fields around a microwave oven, static electricity, cordless phone, reception sensitivity, antenna's performance, operating system, software application, etc.	



HDMI	North American and Japanese models	European, Middle East, Australian and Asian models
Input		4
Output		1

	HDMI IN *1				HDMI OUT
	BD/DVD	CBL/SAT	PC	GAME	
bandwidth	40Gbps	40Gbps	40Gbps	40Gbps	40Gbps
ALLM	✓	✓	✓	✓	✓
Gaming-VRR	✓	✓	✓	✓	✓
QFT	✓	✓	✓	✓	✓
SBTM	✓	✓	✓	✓	✓
DSC	✓	✓	✓	✓	✓
Uncompressed	8K/60p 4:2:0	8K/60p 4:2:0	8K/60p 4:2:0	8K/60p 4:2:0	8K/60p 4:2:0
Compressed (TV needs DSC)	8K/60p 4:4:4	8K/60p 4:4:4	8K/60p 4:4:4	8K/60p 4:4:4	8K/60p 4:4:4
ARC *2					✓
HDR10 / HLG (BT.2020)	✓	✓	✓	✓	✓
HDR10+	✓	✓	✓	✓	✓

*1 Compatible Audio Format: 2 ch linear PCM (32 kHz, 44.1 kHz, 48 kHz, 88.2 kHz, 96 kHz, 176.4 kHz, 192 kHz, 16/20/24 bit)
DSD(2.8 MHz)

*2 ARC compatible audio format: PCM



Corresponding input resolutions	Frame rate	Color space	Color depth	HDMI Input
4K (3840x2160p) 4K SMPTE (4096x2160p)	24/25/30 Hz	YCbCr4:2:2	12 bit	✓
		YCbCr4:4:4/RGB	8 bit	✓
			10/12 bit	✓
	48/50/60 Hz	YCbCr4:2:0	8 bit	✓
			10/12 bit	✓
			12 bit	✓
		YCbCr4:4:4/RGB	8 bit	✓
			10/12 bit	✓
			12 bit	✓
	100/120 Hz	YCbCr4:2:0	8/10/12 bit	✓
			12 bit	✓
		YCbCr4:4:4/RGB	8/10 bit	✓
12 bit			✓(*1)	
5K (5120x2160p)	24/25/30 Hz	YCbCr4:2:2	12 bit	✓
		YCbCr4:4:4/RGB	8 bit	✓
			10/12 bit	✓
	48/50/60 Hz	YCbCr4:2:0	8/10/12 bit	✓(*2)
			12 bit	✓
			8 bit	✓
		YCbCr4:4:4/RGB	10/12 bit	✓
			12 bit	✓
			8 bit	✓
8K (7680x4320p)	24/25/30 Hz	YCbCr4:2:0	8/10/12 bit	✓
		YCbCr4:2:2	12 bit	✓
		YCbCr4:4:4/RGB	8/10 bit	✓
			12 bit	✓(*1)
	48/50/60 Hz	YCbCr4:2:0	8/10 bit	✓
			12 bit	✓(*1)
		YCbCr4:2:2	12 bit	✓(*1)
		YCbCr4:4:4/RGB	8/10/12 bit	✓(*1)
			12 bit	✓(*1)

(*1) Video compressed with DSC (Display Stream Compression) can be input and output. DSC is a video compression technique that enables the transmission of high-resolution video, which requires high bandwidth, via HDMI. While playing this video format, there is no on-screen display when you perform such operations as using the AUDIO Menu or adjusting the volume.

(*2) 5K, 48 Hz, YCbCr4:2:0, 8/10/12 bit is not supported.



Network Section	North American and Japanese models	European, Middle East, Australian and Asian models
Ethernet LAN	1 (10BASE-T/100BASE-TX)	
Wireless LAN	IEEE 802.11 a/b/g/n/ac standard (Wi-Fi® standard) 5 GHz/2.4 GHz band	
<p>■ Music Server (→ p68) Supported Audio Formats</p>	<p>MP3 (.mp3)</p> <ul style="list-style-type: none"> • MPEG-1/MPEG-2 Audio Layer-3/44.1 kHz, 48 kHz/Between 8 kbps and 320 kbps, and VBR/2 ch <p>WMA (.wma)</p> <ul style="list-style-type: none"> • 44.1 kHz, 48 kHz/Between 5 kbps and 320 kbps, and VBR/2 ch <p>WAV (.wav)</p> <p>WAV files contain uncompressed PCM digital audio.</p> <ul style="list-style-type: none"> • 44.1 kHz, 48 kHz, 88.2 kHz, 96 kHz, 176.4 kHz, 192 kHz/8 bit, 16 bit, 24 bit/2 ch <p>AIFF (.aiff/.aif)</p> <p>AIFF files contain uncompressed PCM digital audio.</p> <ul style="list-style-type: none"> • 44.1 kHz, 48 kHz, 88.2 kHz, 96 kHz, 176.4 kHz, 192 kHz/8 bit, 16 bit, 24 bit/2 ch <p>AAC (.aac/.m4a/.mp4/.3gp/.3g2)</p> <ul style="list-style-type: none"> • MPEG-2/MPEG-4 Audio/44.1 kHz, 48 kHz, 88.2 kHz, 96 kHz/Between 8 kbps and 320 kbps, and VBR/2 ch <p>FLAC (.flac)</p> <ul style="list-style-type: none"> • 44.1 kHz, 48 kHz, 88.2 kHz, 96 kHz, 176.4 kHz, 192 kHz/8 bit, 16 bit, 24 bit/2 ch <p>LPCM (Linear PCM)</p> <ul style="list-style-type: none"> • 44.1 kHz, 48 kHz/16 bit/2 ch <p>Apple Lossless (.m4a/.mp4)</p> <ul style="list-style-type: none"> • 44.1 kHz, 48 kHz, 88.2 kHz, 96 kHz, 176.4 kHz, 192 kHz/16 bit, 24 bit/2 ch <p>DSD (.dsf/.dff)</p> <ul style="list-style-type: none"> • DSF/DSDIFF/2.8 MHz, 5.6 MHz, 11.2 MHz/2 ch 	



USB Section	North American and Japanese models	European, Middle East, Australian and Asian models
USB	2 (Front: Ver.2.0, 5 V/0.5 A, Rear: Ver.2.0, 5 V/1A)	
<p>■ USB Storage Device (→p66) Supported Audio Formats</p>	<p>MP3 (.mp3)</p> <ul style="list-style-type: none"> • MPEG-1/MPEG-2 Audio Layer-3/44.1 kHz, 48 kHz/Between 8 kbps and 320 kbps, and VBR/2 ch <p>WMA (.wma)</p> <ul style="list-style-type: none"> • 44.1 kHz, 48 kHz/Between 5 kbps and 320 kbps, and VBR/2 ch <p>WAV (.wav)</p> <p>WAV files contain uncompressed PCM digital audio.</p> <ul style="list-style-type: none"> • 44.1 kHz, 48 kHz, 88.2 kHz, 96 kHz, 176.4 kHz, 192 kHz/8 bit, 16 bit, 24 bit/2 ch <p>AIFF (.aiff/.aif)</p> <p>AIFF files contain uncompressed PCM digital audio.</p> <ul style="list-style-type: none"> • 44.1 kHz, 48 kHz, 88.2 kHz, 96 kHz, 176.4 kHz, 192 kHz/8 bit, 16 bit, 24 bit/2 ch <p>AAC (.aac/.m4a/.mp4/.3gp/.3g2)</p> <ul style="list-style-type: none"> • MPEG-2/MPEG-4 Audio/44.1 kHz, 48 kHz, 88.2 kHz, 96 kHz/Between 8 kbps and 320 kbps, and VBR/2 ch <p>FLAC (.flac)</p> <ul style="list-style-type: none"> • 44.1 kHz, 48 kHz, 88.2 kHz, 96 kHz, 176.4 kHz, 192 kHz/8 bit, 16 bit, 24 bit/2 ch <p>Apple Lossless (.m4a/.mp4)</p> <ul style="list-style-type: none"> • 44.1 kHz, 48 kHz, 88.2 kHz, 96 kHz, 176.4 kHz, 192 kHz/16 bit, 24 bit/2 ch <p>DSD (.dsf/.dff)</p> <ul style="list-style-type: none"> • DSF/DSDIFF/2.8 MHz, 5.6 MHz, 11.2 MHz/2 ch 	



General	North American and Japanese models	European, Middle East, Australian and Asian models
Power Supply	(North American models) AC 120 V, 60 Hz (Japanese models) AC 100 V, 50/60 Hz	AC 220 - 240 V, 50/60 Hz
Power Consumption	(North American models) 265 W (Japanese models) 210 W	275 W
Full Standby mode	0.2 W	0.2 W
Network Standby (wired)	(North American models) 1.7 W (Japanese models) 1.6 W	1.8 W
Network Standby (wireless)	1.5 W	1.6 W
Bluetooth Wakeup	(North American models) 1.6 W (Japanese models) 1.5 W	1.7 W
HDMI CEC Standby	0.2 W	0.3 W
Standby mode (ALL ON)	(North American models) 2.0 W (Japanese models) 2.1 W	2.2 W
Dimensions (W x H x D)	435 mm x 149.5 mm x 329 mm 17-1/8" x 5-7/8" x 12-15/16"	
Weight	9 kg (19.8 lbs.)	
Maximum radio-frequency power transmitted in the frequency band(s)	-	(European models) 2400 MHz - 2483.5 MHz (20 dBm (e.i.r.p)) 5150 MHz - 5350 MHz (23 dBm (e.i.r.p)) 5470 MHz - 5725 MHz (23 dBm (e.i.r.p))



Audio Inputs	North American and Japanese models	European, Middle East, Australian and Asian models
Analog	4 (Including 1xPHONO)	
Digital	3 (COAXIALx1, OPTICALx2) • Supported sampling rates for PCM signals (stereo, mono) from a digital input are 32 kHz, 44.1 kHz, 48 kHz, 88.2 kHz, 96 kHz/16 bit, 20 bit, and 24 bit.	

Audio Outputs	North American and Japanese models	European, Middle East, Australian and Asian models
Analog	MAIN PRE OUT L/R x1, SUBWOOFER PRE OUT x1, ZONE 2 PRE/LINE OUT x1	
Speaker Outputs	SPEAKERS A L/R x1 (Ready to receive banana plugs), SPEAKERS B L/R x1 (Ready to receive banana plugs)	SPEAKERS A L/R x1, SPEAKERS B L/R x1
Phones	1 (ø 6.3 mm, 1/4")	

Specifications and features are subject to change without notice.

 → [License and Trademark](#)



ONKYO

SN 29404148A_EN

© Copyright 2024 Premium Audio Company Technology Center K.K. All rights reserved. ©2024 Premium Audio Company Technology Center K.K. Tous droits de reproduction et de traduction réservés.
Privacy Policy, available at [<https://www.onkyo.com/privacy/>]

O2404-1