

FRONT

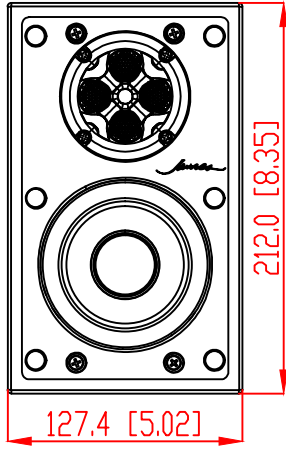

BACK / MINIMUM CUTOUT

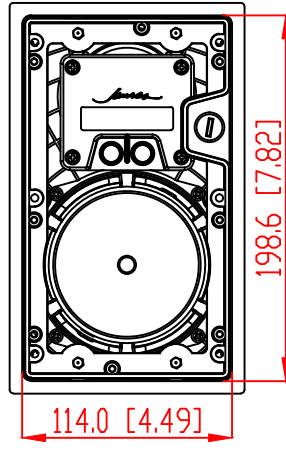

MOUNTING DEPTH

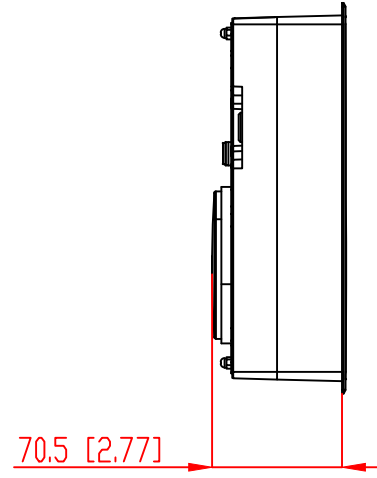

MICRO TRIM GRILLE

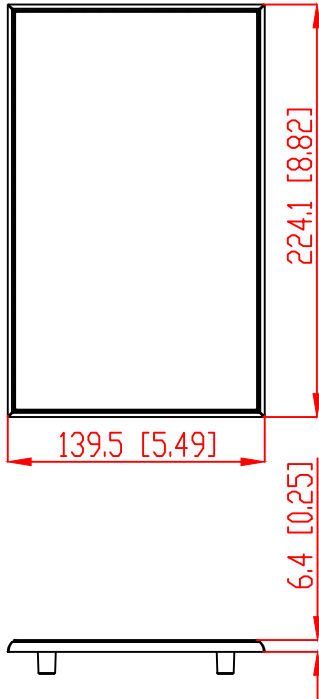

TRIMLESS GRILLE

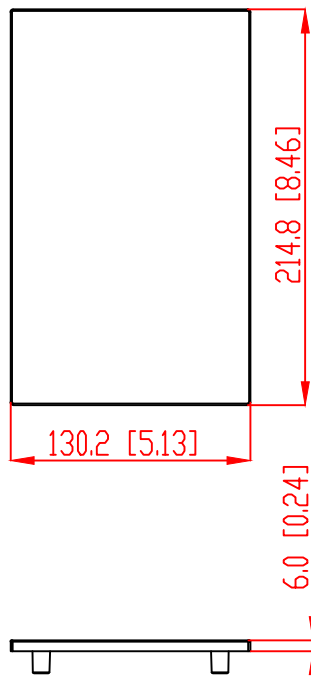

ISOMETRIC

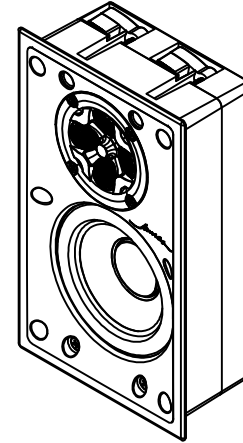

2185 Park Place
Minden, Nevada 89423 USA
775-461-7500
www.jamesloudspeaker.com



VXQ48 SPEAKER

SCALE: 1:1

DRAWN BY: Roy

DRWN - PART NUMBER

REV.

SHEET: 0F

RELEASED DIM

FRONT

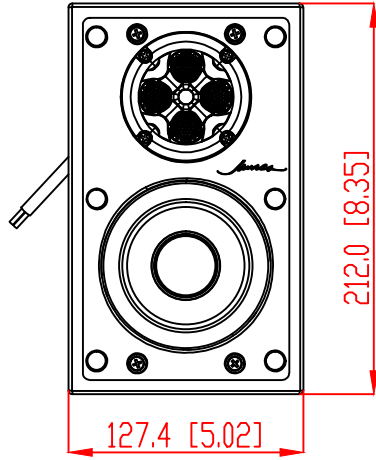

BACK / MINIMUM CUTOUT

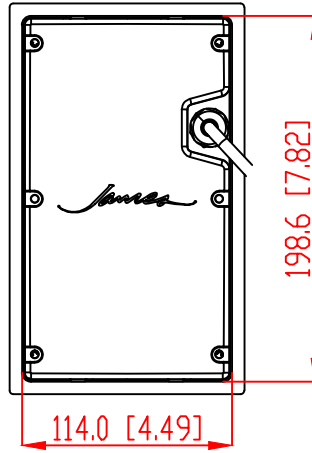

MOUNTING DEPTH

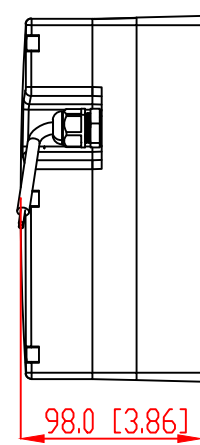

MICRO TRIM GRILLE

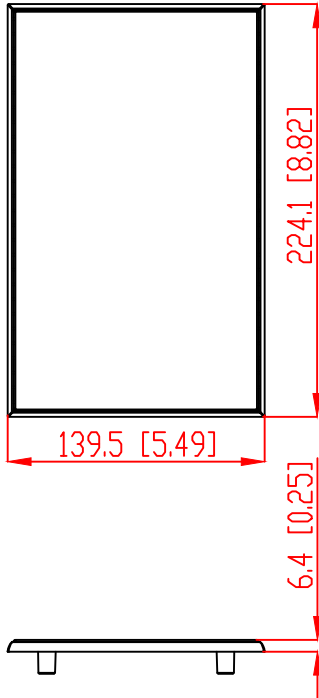

TRIMLESS GRILLE

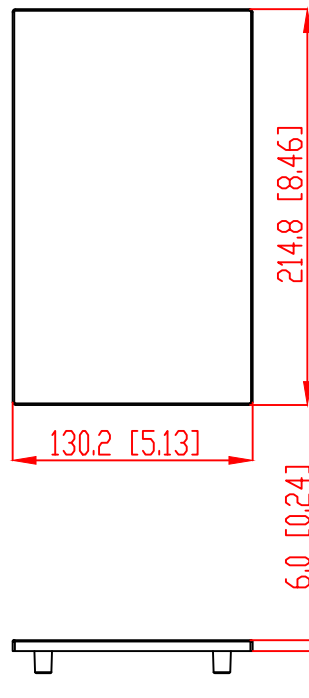

ISOMETRIC

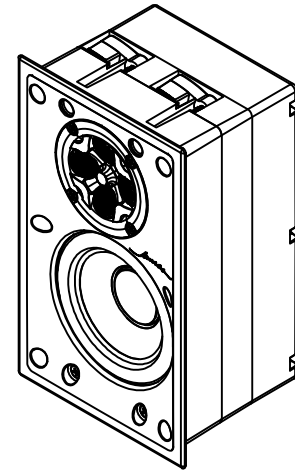

2185 Park Place
Minden, Nevada 89423 USA
775-461-7500
www.jamesloudspeaker.com



VXQ48 WITH ENCLOSURE SPEAKER

SCALE: 1 : 1
SHEET: 01

DRAWN BY: Roy
RELEASED ON:

DRWN - PART NUMBER

REV.