



RAZER BASILISK V3 PRO

MASTER GUIDE

The king returns to raise the game. Enter the **Razer Basilisk V3 Pro**—the most advanced gaming mouse. Armed to the teeth with industry-leading technology, unlock your maximum potential with a weapon that pushes the known limits of performance, customization, connectivity, and control.

CONTENTS

1. WHAT'S INSIDE	3
2. WHAT'S NEEDED	4
3. LET'S GET YOU COVERED	5
4. TECHNICAL SPECIFICATIONS.....	6
5. SETTING UP YOUR RAZER BASILISK V3 PRO.....	7
6. USING YOUR RAZER BASILISK V3 PRO.....	11
7. CONFIGURING YOUR RAZER BASILISK V3 PRO VIA RAZER SYNAPSE	13
8. SAFETY AND MAINTENANCE	32
9. LEGALESE	34

1. WHAT'S INSIDE

- Razer Basilisk V3 Pro

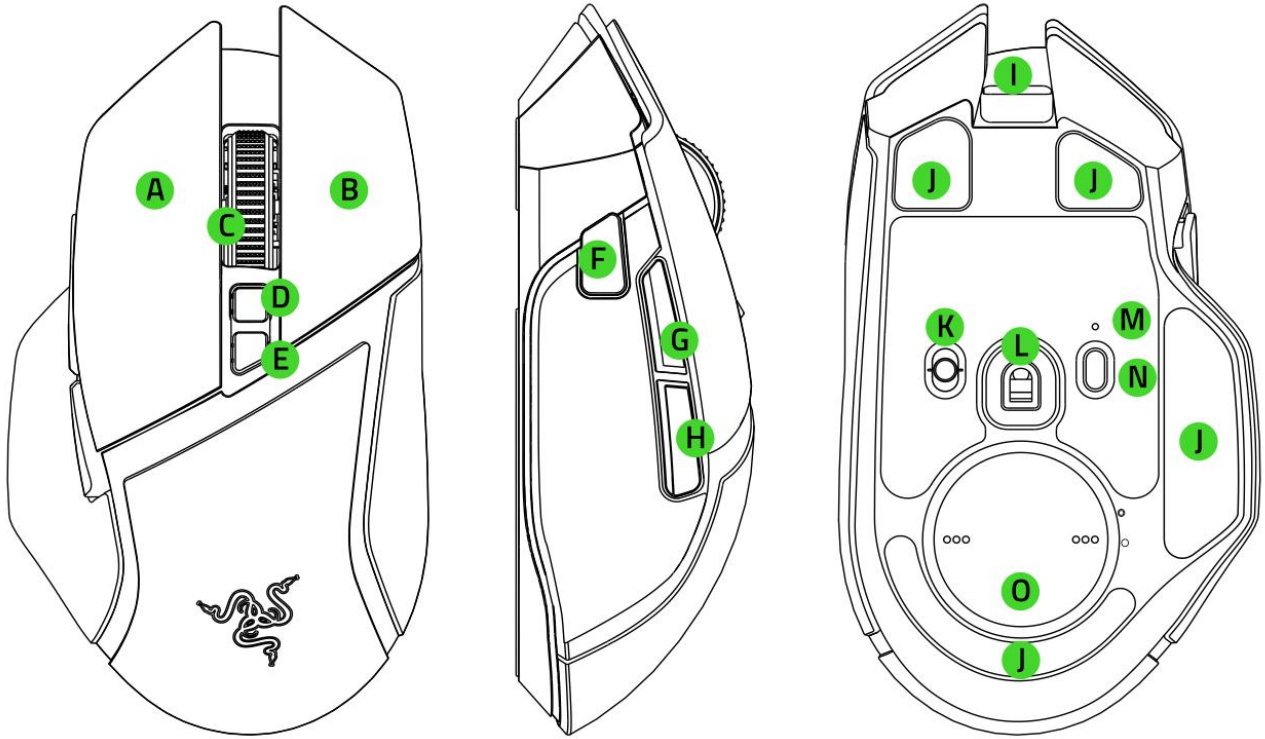

- A.** Left mouse button
- B.** Right mouse button
- C.** Razer™ HyperScroll Tilt Wheel
- D.** Scroll mode button
 - Free-Spin Scrolling mode
 - Tactile Cycling mode
- E.** DPI cycle button*
- F.** Multi-function trigger
- G.** Mouse button 5
- H.** Mouse button 4
- I.** USB Type C port

- J.** Ultraslick mouse feet
- K.** Slider switch
 - Bluetooth mode
 - Power off mode
 - Razer™ HyperSpeed Wireless (2.4 GHz) mode
- L.** Razer Focus Pro 30K Optical Sensor
- M.** Profile indicator
- N.** Profile button
- O.** Wireless USB dongle compartment / Cover puck**

*The DPI stages are 400, 800, 1600 (default), 3200, and 6400; and can be customized using Razer Synapse.

**Interchangeable with the Razer Wireless Charging Puck for wireless charging via Razer Mouse Dock Pro (each sold separately).

- USB dongle adapter + Wireless USB dongle

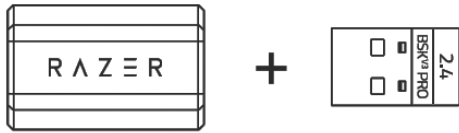

- USB Type A to USB Type C Speedflex cable

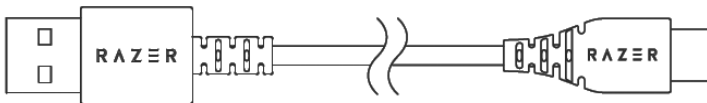

- Important Product Information Guide

2. WHAT'S NEEDED

PRODUCT REQUIREMENTS

- USB Type A port or Bluetooth connectivity

RAZER SYNAPSE REQUIREMENTS

- Windows® 10 64-bit (or higher)
- Internet connection for software installation

3. LET'S GET YOU COVERED



Register your product and score exclusive benefits

razerid.razer.com/warranty

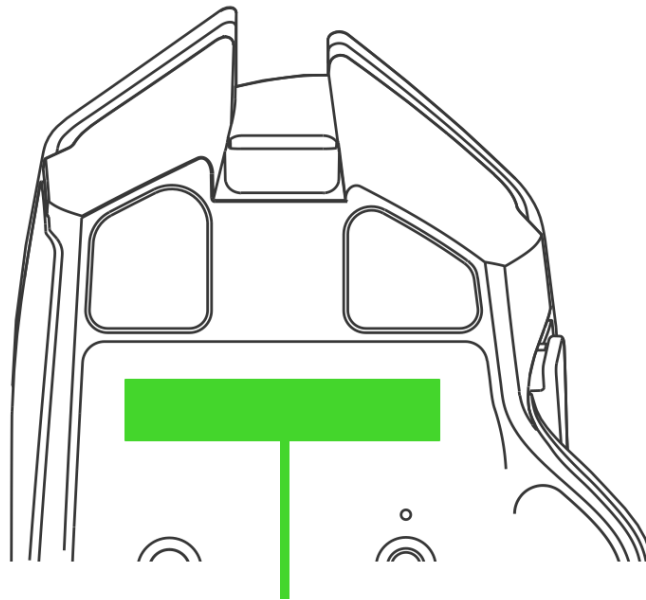

*Your product's serial number
can be found here.*

4. TECHNICAL SPECIFICATIONS

- True 30,000 DPI Focus Pro optical sensor with 99.8% resolution accuracy
- Up to 750 inches per second (IPS) / 70 G acceleration
- Advanced Lift-off/Landing distance customization
- Dual wireless - HyperSpeed (2.4 GHz) and BLE
- Eleven independently programmable buttons
- Razer™ Optical Mouse Switches Gen-3 rated for 90 M clicks
- Ergonomic right-handed design with injection molded rubber grips
- 4-way Razer™ HyperScroll tilt wheel with electronically actuated notched and free-spinning modes
- On-The-Fly Sensitivity Adjustment (Default stages: 400/800/1600/3200/6400)
- Hybrid On-board and Cloud Storage (4+1 profiles)
- Razer Synapse 3 enabled
- 13 Razer Chroma™ lighting zones with true 16.8 million customizable color options
- 1.8 m / 6 ft Speedflex USB Type C cable for charging and wired use
- Razer Mouse Dock Pro and Wireless Charging Puck compatible

5. SETTING UP YOUR RAZER BASILISK V3 PRO

CHARGING YOUR MOUSE

Plug the charging cable from your PC's USB port to the Razer Basilisk V3 Pro. For best results, please fully charge the mouse before using it for the first time. A depleted battery will be fully charged in approximately 4 hours.

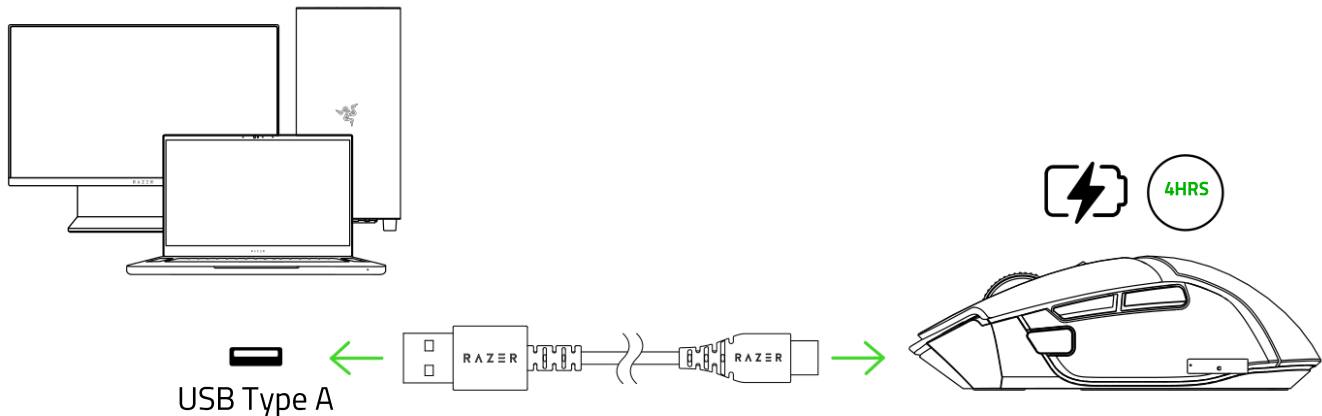

i Install Razer Synapse when prompted or download the installer from razer.com/synapse

CONNECTING YOUR MOUSE

A. Via wired mode

Connect the mouse to any of your PC's USB ports using the charging cable to use it in wired mode.

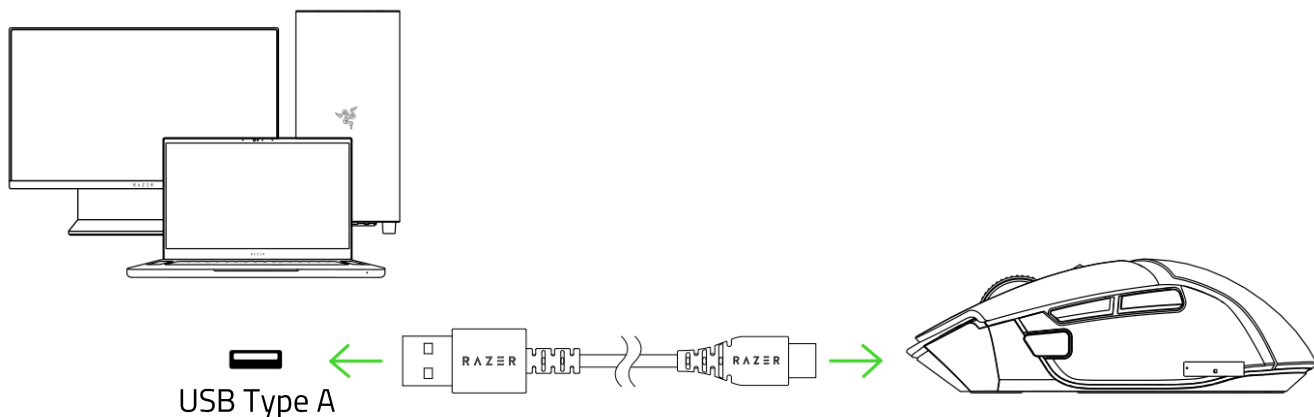

B. Via Razer™ HyperSpeed Wireless (2.4 GHz) mode

1. Plug the wireless USB dongle into your PC.

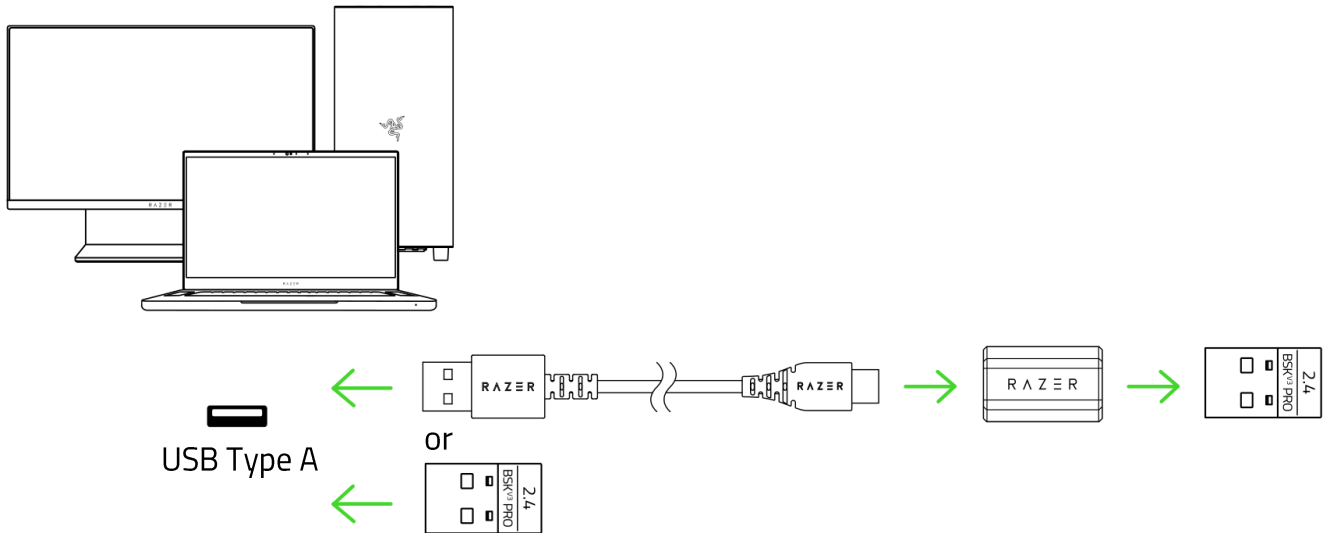

2. Push the slider switch to 2.4 GHz mode.

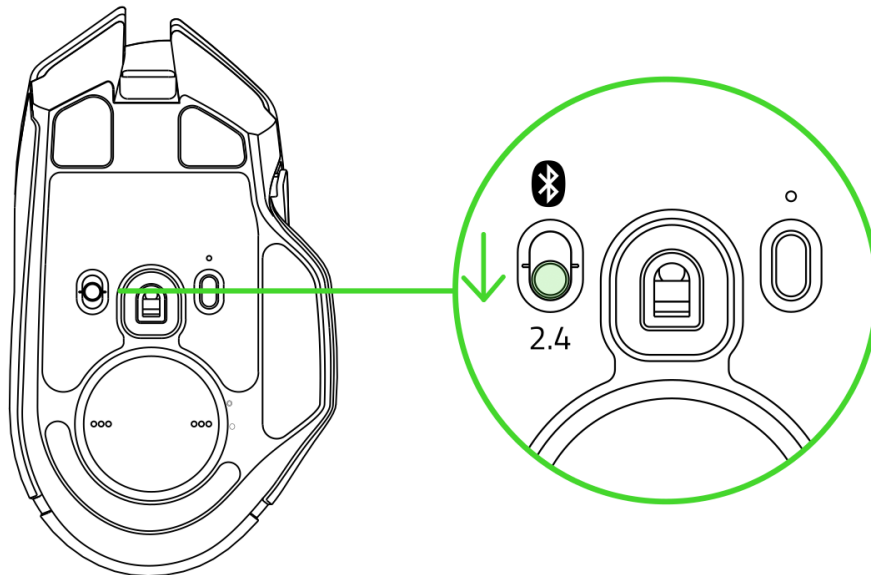

The Razer Basilisk V3 Pro is now ready for use in 2.4 GHz wireless mode.

C. Via Bluetooth mode

1. Push the slider switch to Bluetooth mode (⌘).

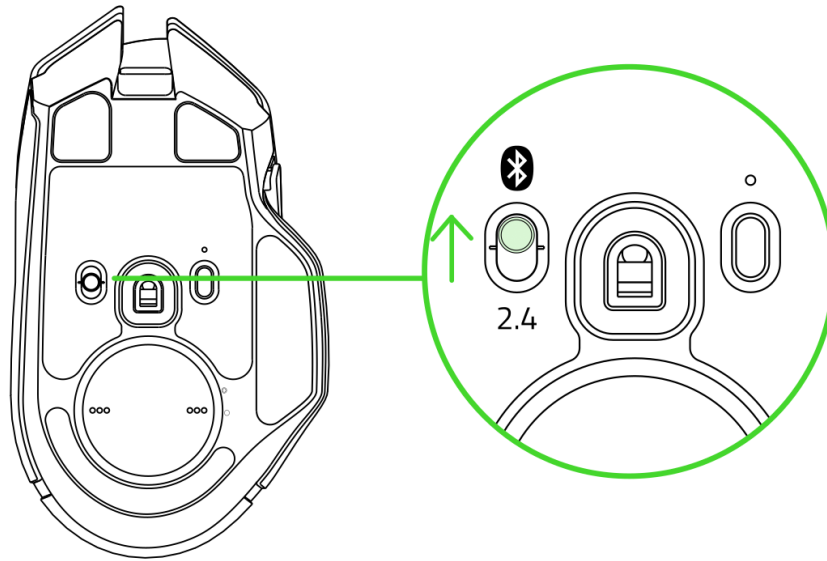

2. Press and hold the scroll wheel, mouse 4, and mouse 5 buttons simultaneously for 3 seconds to activate pairing mode. The scroll wheel and Razer logo will blink twice in repeated intervals to show that the device is in pairing mode.

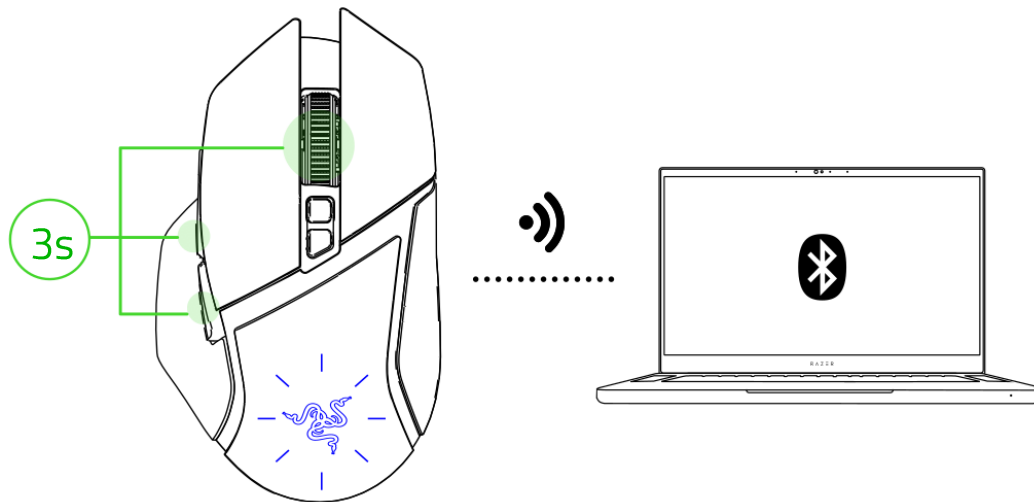

Pairing mode

3. Activate Bluetooth on your device and select "**Razer Basilisk V3 Pro**" from the list of devices found.

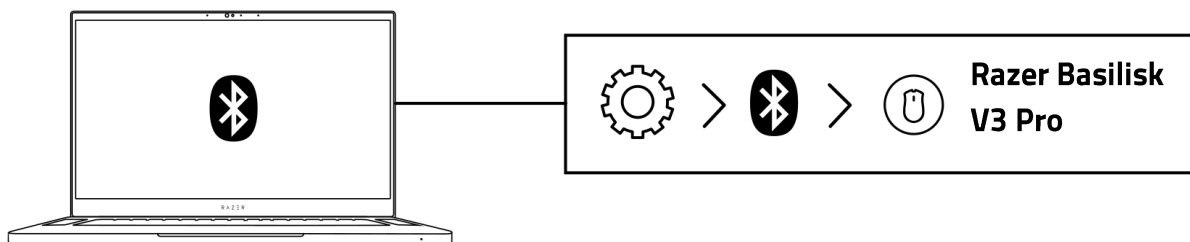

4. Wait until the mouse pairs with your device. The scroll wheel and the Razer logo will briefly turn static blue when paired.

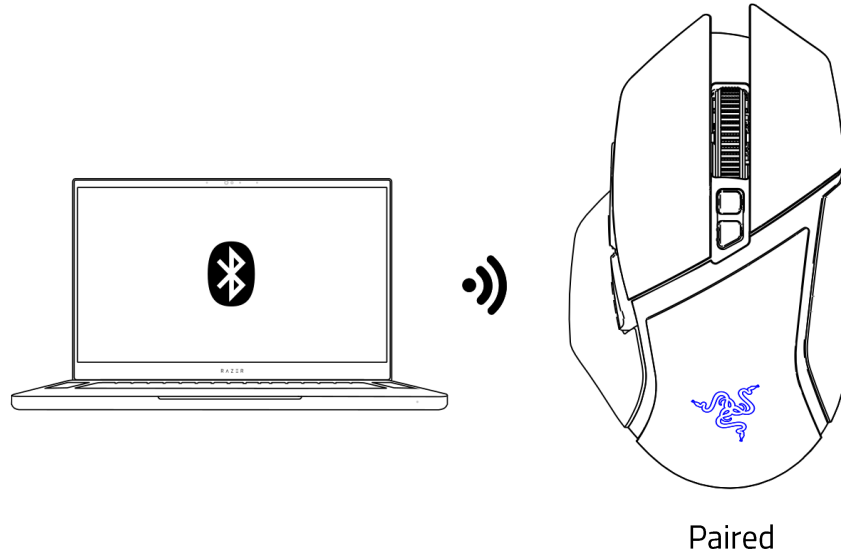

The Razer Basilisk V3 Pro is now ready for use in Bluetooth mode.

6. USING YOUR RAZER BASILISK V3 PRO

PERSONALIZING YOUR MOUSE

Your Razer Basilisk V3 Pro can store up to 5 profiles from the Razer Synapse app, allowing you to use these profiles even on systems without the app installed. Pressing the profile button will cycle through the different profiles, with the profile indicator's color showing which profile is currently selected. [Learn more about Stored profiles](#)

Profile	Designated color
Active Profile	White
Profile 1	Red
Profile 2	Green
Profile 3	Blue
Profile 4	Cyan

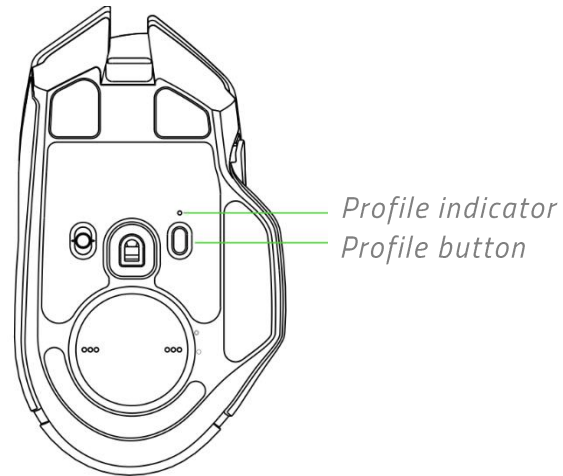

! Install Razer Synapse when prompted or download the installer from razer.com/synapse

MULTI-FUNCTION TRIGGER

The Razer Basilisk V3 Pro has a multi-function trigger that temporarily allows you to change the mouse's sensitivity when held down.

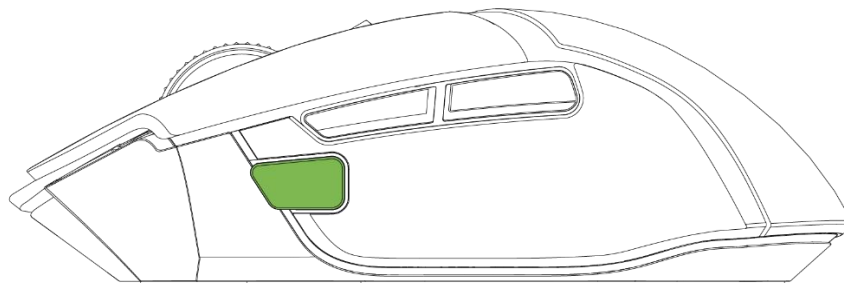

! The multi-function trigger can be customized for different tasks using Razer Synapse.

SWITCHING SCROLL MODES

The scroll mode button allows you to control how you speed through content using the Razer™ HyperScroll Tilt Wheel. Simply press the scroll mode button to switch between Free-Spin Scrolling for unbridled scroll wheel navigation and Tactile Cycling for more precise control of scroll wheel movement.

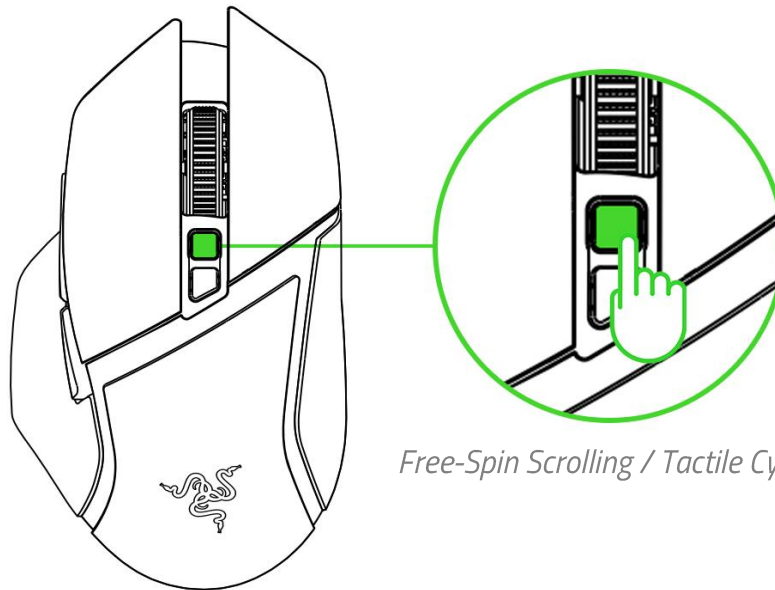

i You can also use Razer Synapse to set the mouse to Smart-reel mode, where the Razer™ HyperScroll Tilt Wheel will automatically switch between Free-spin Scrolling mode and Tactile Cycling mode. [Learn more about Smart-Reel](#)

7. CONFIGURING YOUR RAZER BASILISK V3 PRO VIA RAZER SYNAPSE

i *Internet connection is required for installation, updates, and cloud-based features. Registering for a Razer ID account is recommended but optional. All listed features are subject to change based on the current software version, the connected device(s), and supported apps and software.*

SYNAPSE TAB

The Synapse tab is your default tab when you first launch Razer Synapse. This tab allows you to navigate the Dashboard subtab.

Dashboard

The Dashboard subtab is an overview of your Razer Synapse, where you can access all your Razer devices, modules, and online services.

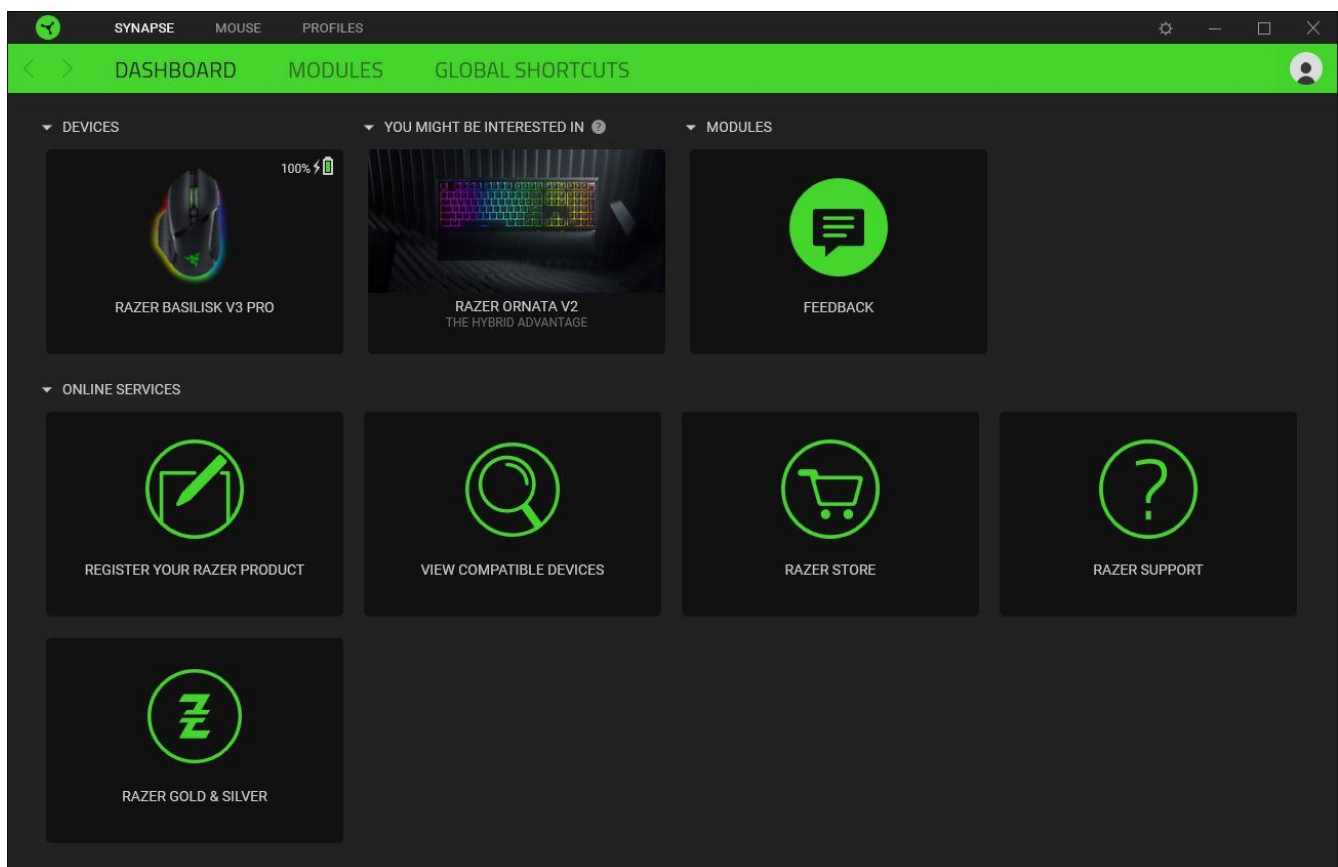

Modules

The Modules subtab displays all installed and available modules for installation.

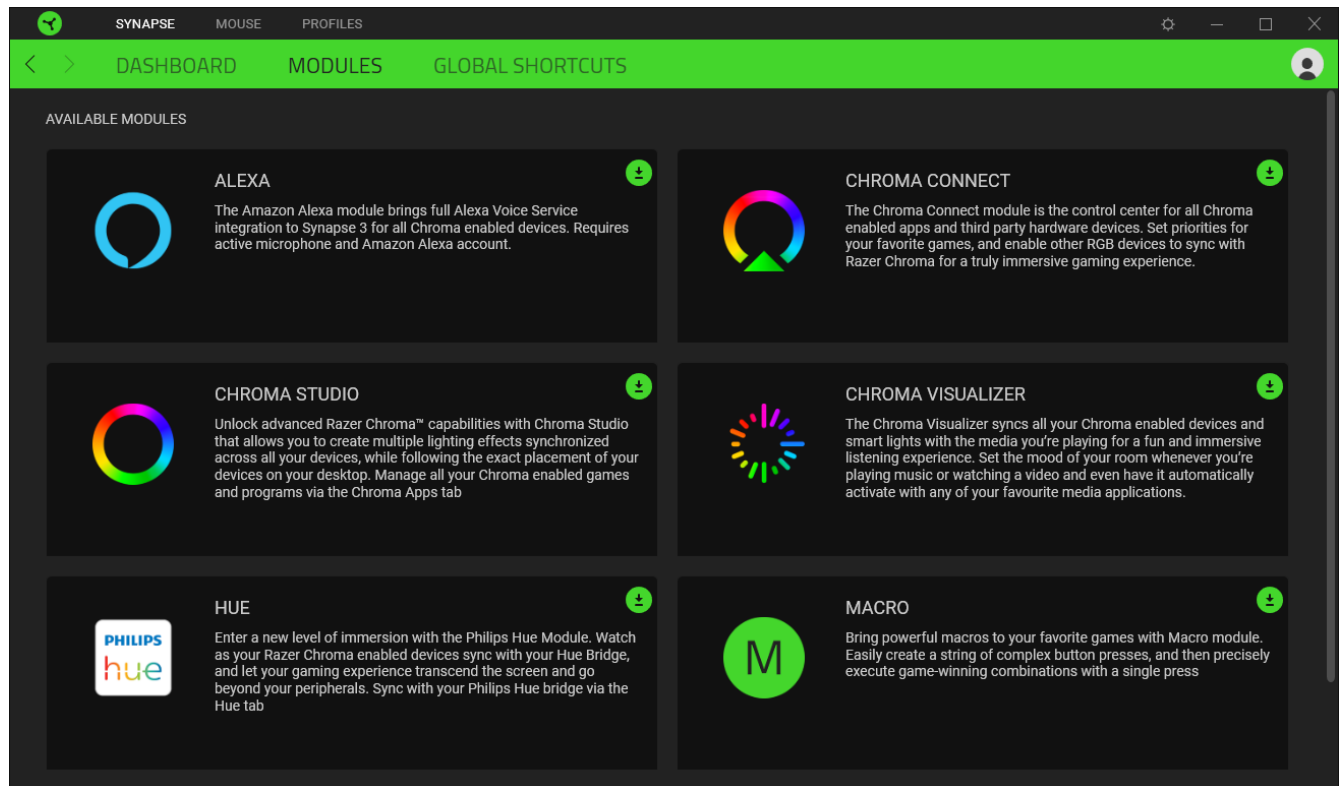

Global Shortcuts

Bind operations or Razer Synapse functions to custom key-combinations from any Razer Synapse-enabled device inputs, which apply across all device profiles. [Learn more about Profiles](#)

! *Only Razer Synapse-enabled device inputs will be recognized.*

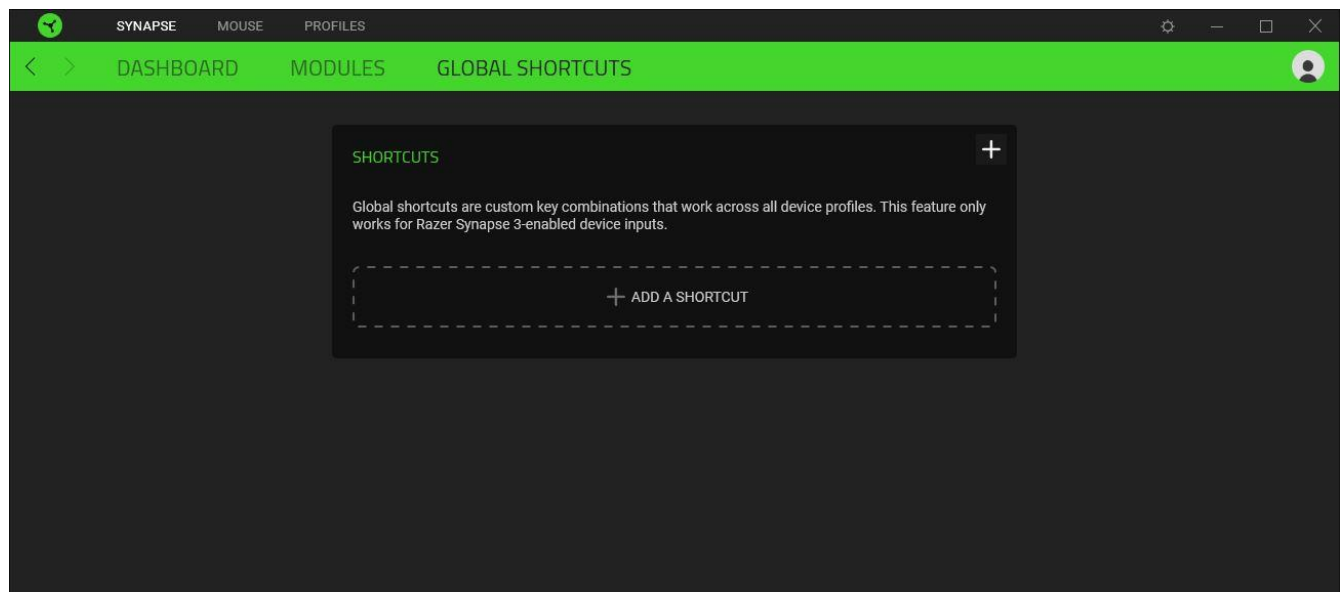

MOUSE TAB

The Mouse tab is the main tab for your Razer Basilisk V3 Pro. From here, you can change your device's settings, such as button assignment, DPI sensitivity, and lighting. Changes made under this tab are automatically saved to your system and cloud storage.

Customize

The Customize subtab is for modifying your mouse's button assignments.

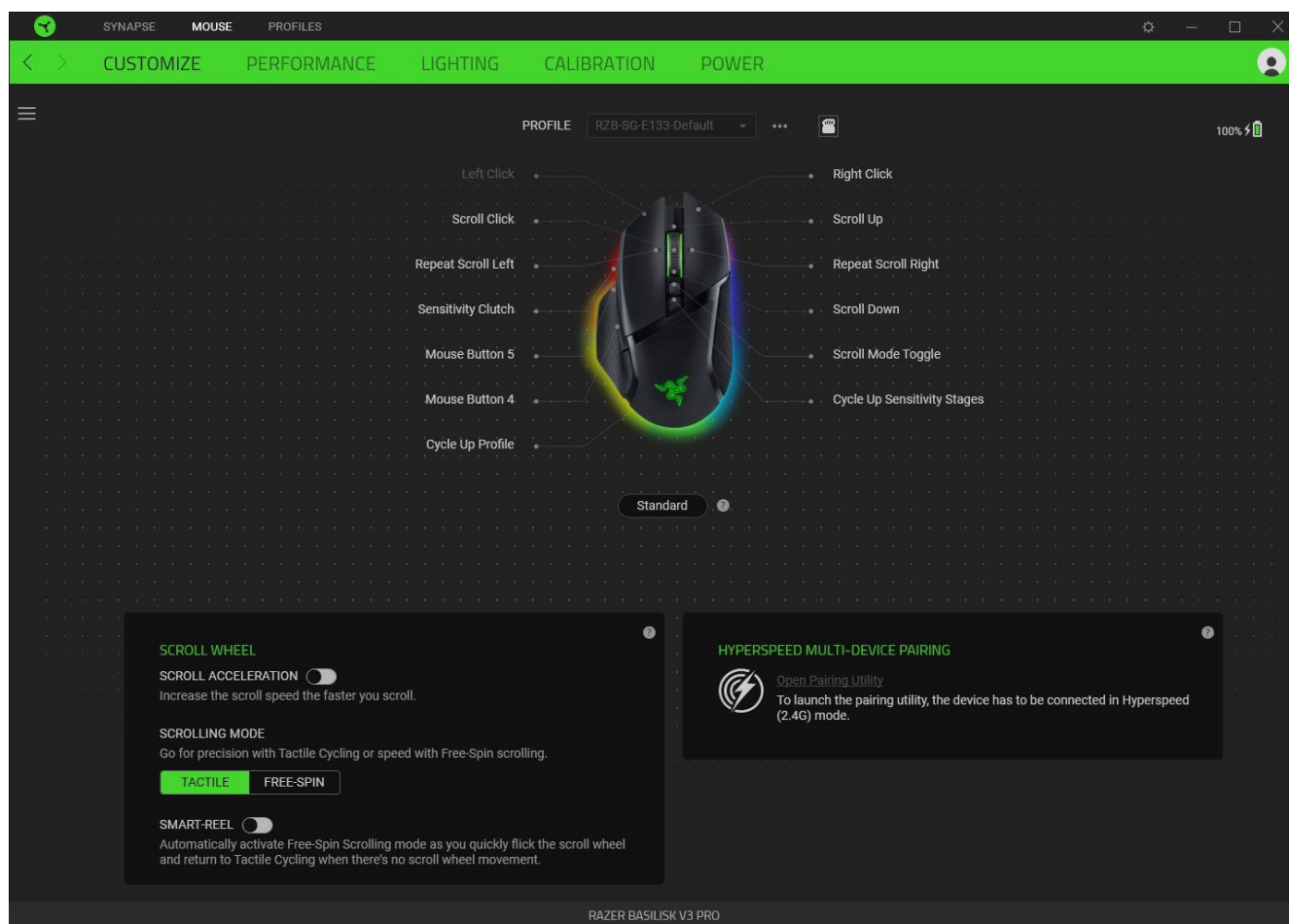

Profile

Profile is a data storage for keeping all your Razer peripheral's settings. By default, the profile name is based on your system's name. To add, rename, duplicate, or delete a profile, simply press the Miscellaneous button (●●●).

Standard / Hypershift

Hypershift mode is a secondary set of button assignments activated when the Hypershift key is held down. By default, the Hypershift key is assigned to the fn key of your Razer Synapse-supported keyboard. However, you can also set any mouse button as a Hypershift key.

Scroll wheel

Customize the way the Razer™ HyperScroll Tilt Wheel speeds through content.

Scroll acceleration

Enable Razer Synapse to detect how fast you scroll and virtually amplify the scroll wheel's movement the faster you scroll through content.

Scrolling mode

Switch between Tactile mode to enjoy more precision with satisfying feedback or Free-spin mode to speed through content with ease.

Smart-Reel

Smart-reel enables the mouse to switch between Free-Spin and Tactile mode automatically. When enabled, the scroll wheel will automatically activate Free-Spin mode when performing fast scrolling movements and revert to Tactile mode when there's no scroll movement.

HyperSpeed Multi-Device Pairing

Use this feature to pair an additional HyperSpeed-compatible device with the wireless USB dongle of your Razer Basilisk V3 Pro. As its wireless USB dongle can support a keyboard and mouse simultaneously, you'll be able to remove the usage of separate dongles for each peripheral.



Your Razer Basilisk V3 Pro must be connected via HyperSpeed (2.4 GHz) wireless mode to use this feature. Each peripheral can only connect to one dongle at a time.

Stored Profiles

Your Razer Basilisk V3 Pro can store up to 5 profiles from the Razer Synapse app, allowing you to use these profiles even on systems without the app installed. To assign a profile to any available on-board memory slots, click the On-board Profiles button (📁) and drag the profile you want to assign to the preferred memory slot.

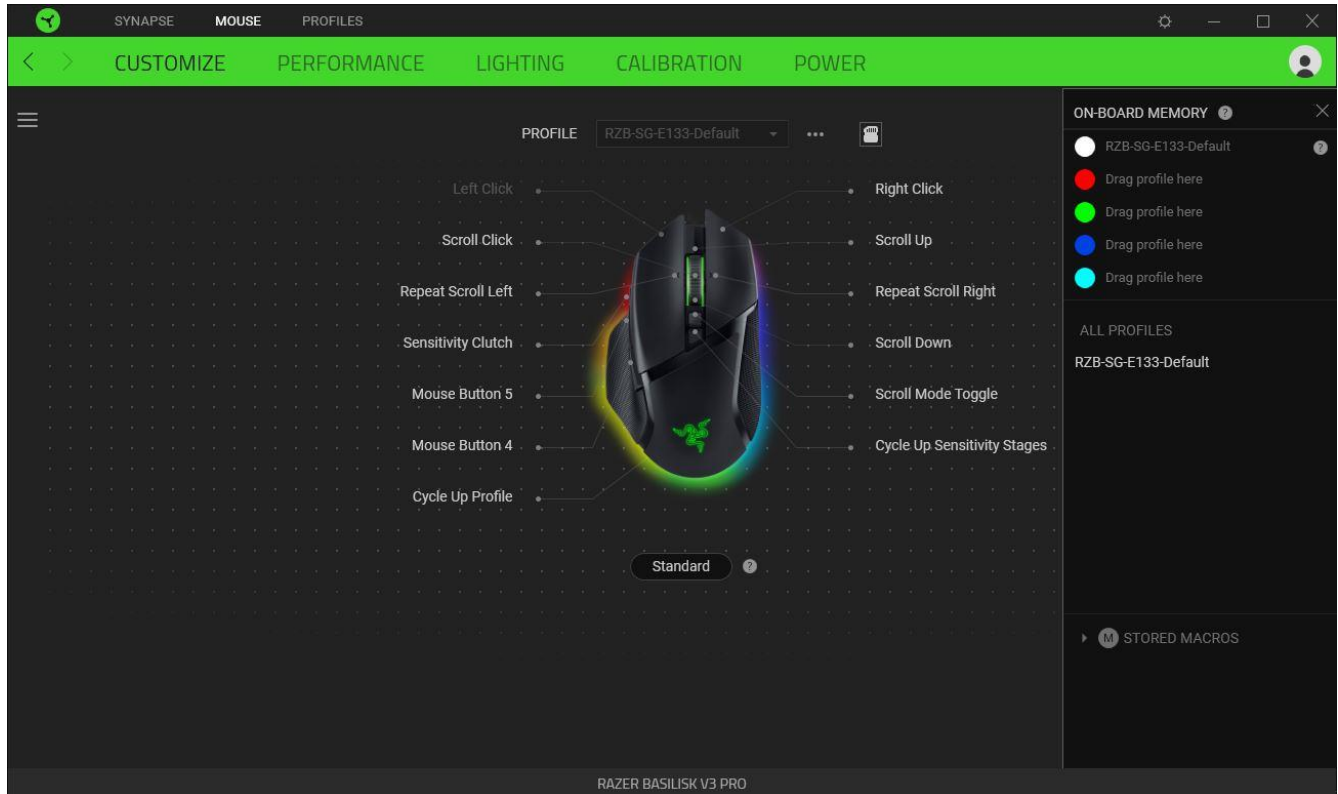

! *The polling rate will also automatically change as you switch between profiles.*

Sidebar

Clicking the Sidebar button (☰) will reveal all current button assignments for your Razer Basilisk V3 Pro.

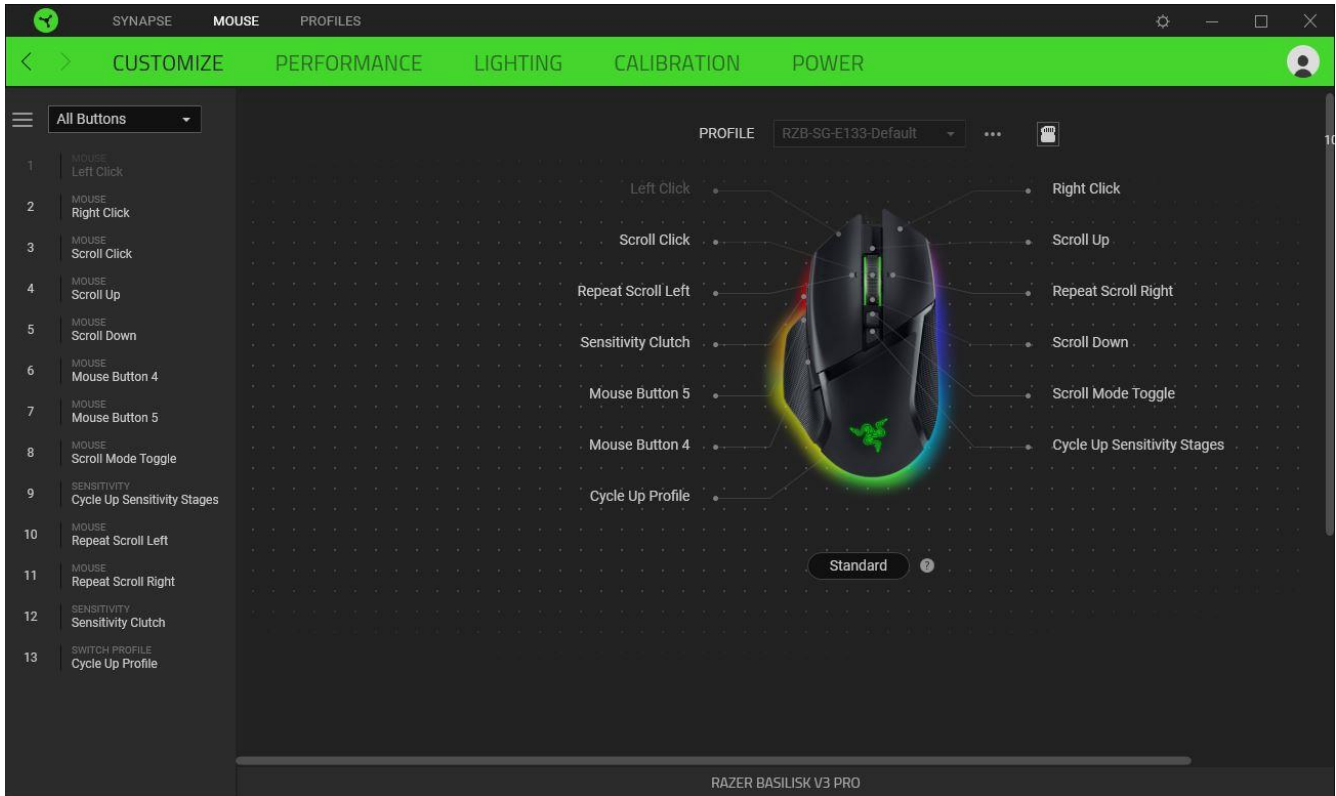

Alternatively, you can skip to a specific button assignment by selecting it on the Customize tab.

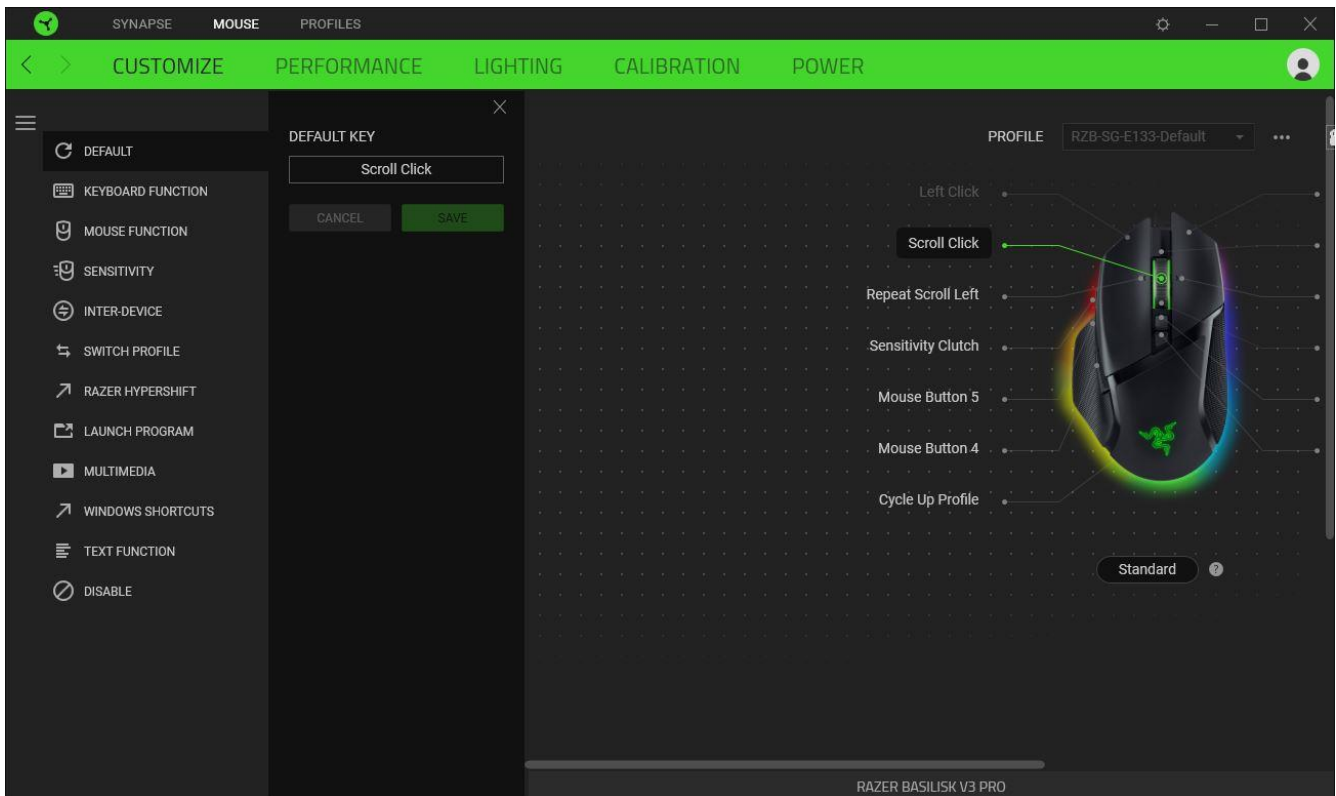

Upon selecting a button assignment, you may then change it to one of the following functions:

Default

This option enables you to return the mouse button to its original setting.

Keyboard Function

This option changes the button assignment into a keyboard function. You can also enable Turbo mode, which allows you to emulate a repeated keyboard function while the button is held down.

Mouse Function

This option substitutes the current button assignment for another mouse function. Listed below are the functions which you can choose from:

- Left Click - Performs a left mouse click using the assigned button.
- Right Click - Performs a right mouse click using the assigned button.
- Scroll Click - Activates the universal scrolling function.
- Double Click - Performs a double left click using the assigned button.
- Mouse Button 4 - Performs a "Backward" command for most internet browsers.
- Mouse Button 5 - Performs a "Forward" command for most internet browsers.
- Scroll Up - Performs a "Scroll Up" command using the assigned button.
- Scroll Down - Performs a "Scroll Down" command using the assigned button.
- Scroll Left - Performs a "Scroll Left" command using the assigned button.
- Scroll Right - Performs a "Scroll Right" command using the assigned button.

You can also choose to enable Turbo mode in some of the mouse functions, which allows you to emulate repeatedly pressing and releasing said function while the button is held down.

Sensitivity

This function allows you to manipulate the DPI setting of your Razer Basilisk V3 Pro with a touch of a button. Listed below are the Sensitivity options and their description:

- Sensitivity Clutch - Changes the sensitivity to a predefined DPI while the designated button is held down. Releasing the button will return it to the previous sensitivity.
- Sensitivity Stage Up - Increases the current sensitivity by one stage.
- Sensitivity Stage Down - Decreases the current sensitivity by one stage.

- On-The-Fly Sensitivity - Pressing the designated button and moving the scroll wheel either up or down will increase or decrease the current DPI.
- Cycle Up Sensitivity Stages - Increases the current sensitivity stage by one. Once it reaches the highest sensitivity stage, it will return to stage 1 when the button is pressed again.
- Cycle Down Sensitivity Stages - Decreases the current sensitivity stage by one. Once it reaches stage 1, it will return to the highest sensitivity stage when the button is pressed again. [Learn more about Sensitivity Stages](#)

M Macro

A Macro is a prerecorded sequence of keystrokes and button presses that is executed with precise timing. You can conveniently execute a chain of commands by setting the button function to Macro. This function will only be visible when the Macro module is installed.

Inter-device

Inter-device allows you to change the functionality of other Razer Synapse-enabled devices. Some of these functionalities are device-specific such as using your Razer gaming keyboard to change the Sensitivity Stage of your Razer gaming mouse.

Switch Profile

Switch Profile lets you quickly change profiles and load a new set of button assignments. An on-screen notification will appear whenever you switch profiles.

Switch Lighting

Switch Lighting allows you to switch between all advanced lighting effects easily. This function will only be visible when the Chroma Studio module is installed.

Razer Hypershift

Setting the button to Razer Hypershift will allow you to activate Hypershift mode as long as the button is held down.

Launch Program

Launch Program lets you open an app or a website using the assigned button. When you select Launch Program, two choices will appear, which require you to search for a specific app you want to open or write the website address you want to visit.

Multimedia

This option allows you to assign multimedia controls to your Razer device. Listed below are the multimedia controls you can choose from:

- Volume Down - Decreases the audio output.
- Volume Up - Increases the audio output.
- Mute Volume - Mutes the audio.
- Mic Volume Up - Increases the microphone volume.
- Mic Volume Down - Decreases the microphone volume.
- Mute Mic - Mutes the microphone.
- Mute All - Mutes both microphone and audio output.
- Play / Pause - Play, pause, or resume playback of the current media.
- Previous Track - Play the previous media track.
- Next Track - Play the next media track.

Windows Shortcuts

This option allows you to assign your preferred button to a Windows Operating System shortcut command. For more information, please visit: support.microsoft.com/kb/126449

Text Function

Text Function enables you to type a prewritten text with a touch of a button. Simply write your desired text on the given field, and your text will be typed whenever the assigned button is pressed. This function has full Unicode support, and you can also insert special symbols from character maps.

Disable

This option renders the assigned button unusable. Use Disable if you do not want to use the selected button or if it interferes with your gaming.

Performance

The Performance subtab allows you to modify the sensitivity, acceleration, and polling rate.

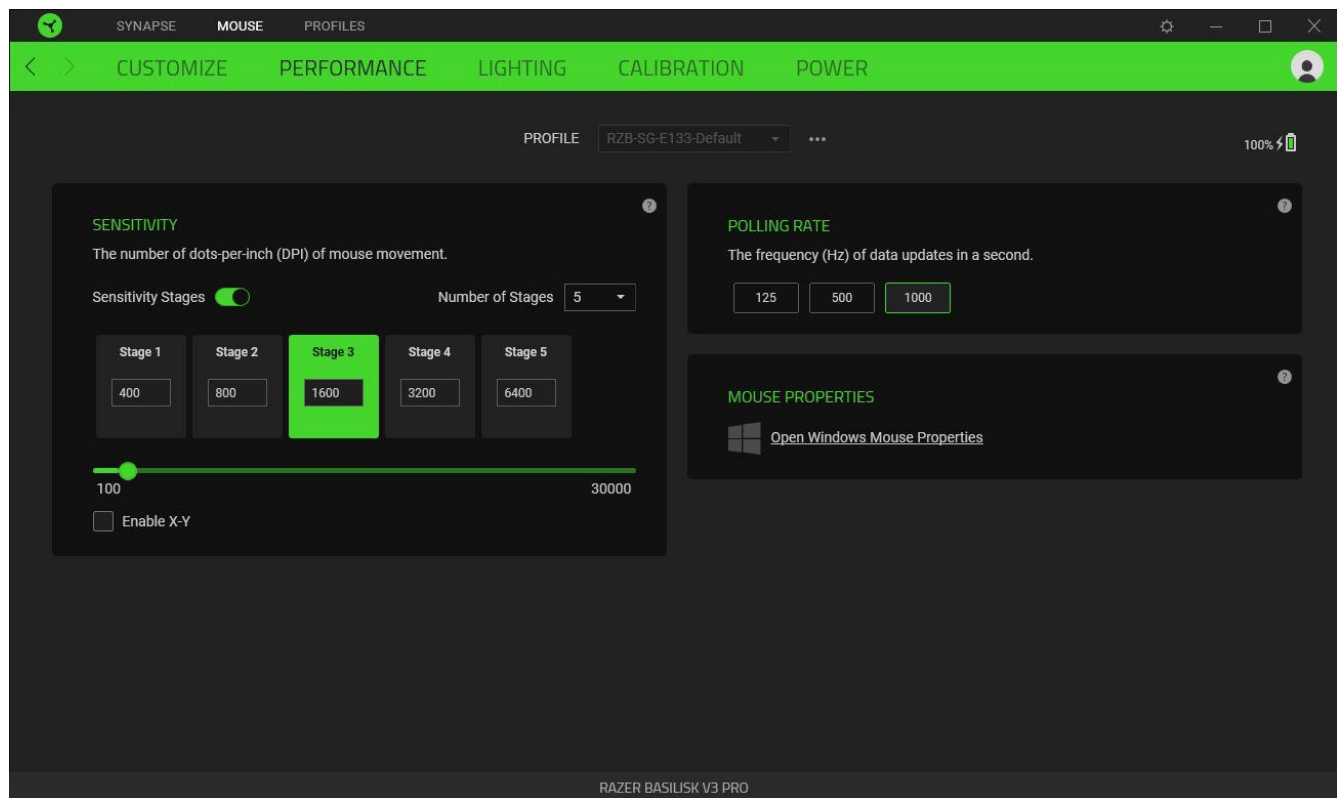

Sensitivity

Sensitivity refers to the distance the cursor will travel based on how far the mouse moved. The higher the DPI, the farther the cursor will travel, given the same mouse movement distance.

Sensitivity Stages

A sensitivity stage is a preset sensitivity value. You can create up to 5 different sensitivity stages, which you can cycle through using the sensitivity stage up/down buttons. You may use the Enable X-Y Sensitivity concurrently with this option.

Enable X-Y Sensitivity

By default, the X-axis (horizontal) and Y-axis (vertical) use the same sensitivity values. However, you may set different sensitivity values to each of the axes by selecting the Enable X-Y Sensitivity option.

Polling Rate

The higher the polling rate, the more often the computer receives information about the status of your mouse, effectively reducing input latency and improving your mouse pointer's reaction time. You can switch between 125Hz, 500Hz, and 1000Hz by selecting your desired polling rate from the options provided.

Mouse Properties

From here, you can access the Windows Mouse Properties, where you modify operating system settings that can directly affect your Razer Basilisk V3 Pro.

Lighting

The Lighting subtab enables you to modify your Razer device's light settings.

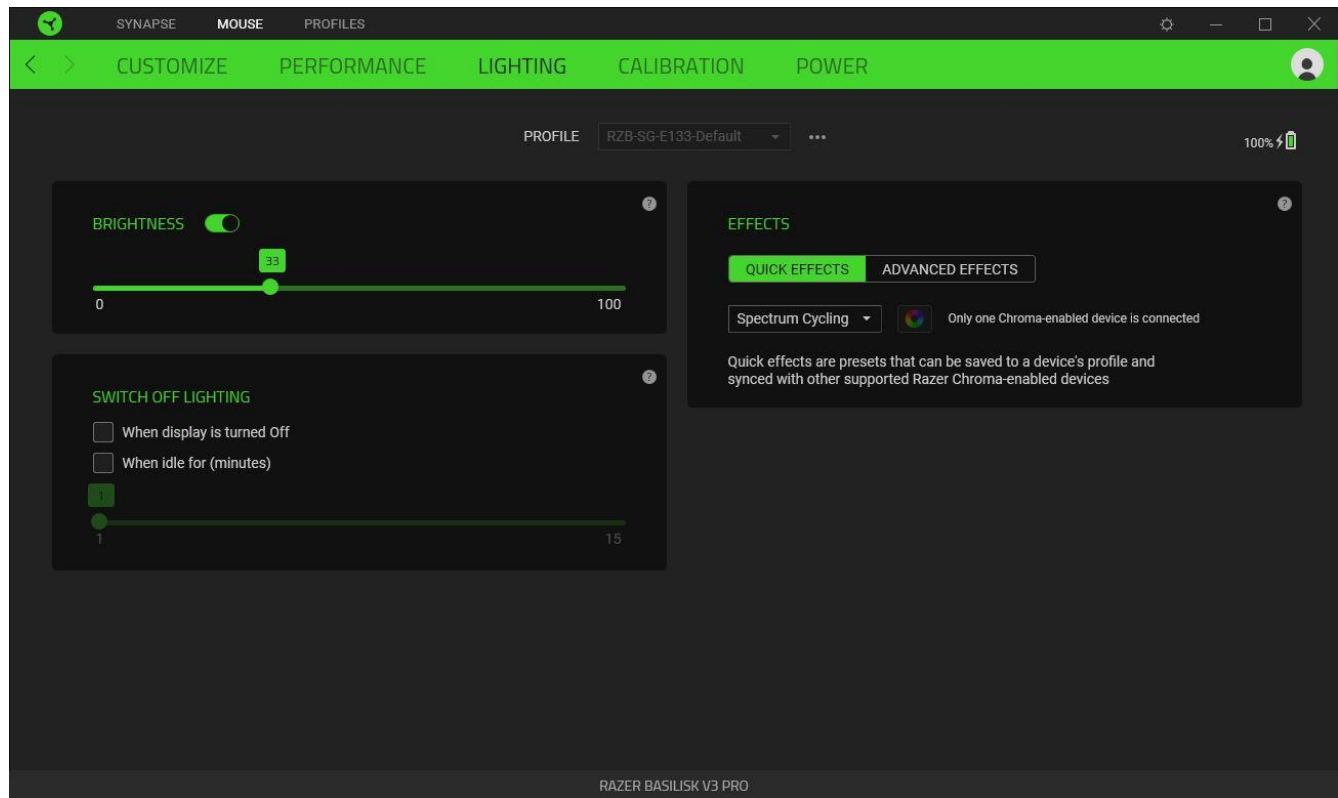

Brightness

You can turn off your Razer device's lighting by toggling the Brightness option or increase/decrease the luminance using the slider.







Switch Off Lighting

This power-saving tool allows you to disable your device's lighting in response to your system's display turning off and/or automatically power down when your Razer Basilisk V3 Pro has been idle for a set amount of time.

Quick effects

Several quick effects can be selected and applied to your mouse's lighting, as listed here:

	Name	Description	How to set up
	Audio meter	The LEDs will light up according to the audio level with a default spectrum of colors	Select a Color Boost level

	Breathing	The lighting will fade in and out of the selected color(s)	Select up to 2 colors or randomize colors
	Fire	The LEDs will light up in warm colors to mimic the motion of flames	No further customization required
	Reactive	The LEDs will light up when you click any of the mouse buttons	Select a color and a duration
	Spectrum cycling	The lighting will cycle between 16.8 million colors indefinitely	No further customization required
	Starlight	Each LED will have a chance of fading in and out at a random time and duration	Select up to 2 colors or randomize colors and select a duration
	Static	The LEDs will remain lit in the selected color	Select a color
	Wave	The lighting will scroll in the direction selected	Select either left-to-right or right-to-left wave direction

If you have other supported Razer Chroma-enabled devices, you can synchronize their quick effects with your Razer device by clicking the Chroma Sync button ().

 *Only devices that support the selected lighting effect will synchronize.*

Advanced Effects

The Advanced Effects option allows you to choose a Chroma Effect you want to use on your Razer Chroma-enabled peripheral. To start making your own Chroma Effect, simply press the Chroma Studio button ().

Calibration

The Calibration subtab allows you to optimize your Razer Precision Sensor to any surface for better tracking.

Smart Tracking

Smart Tracking lets you set the distance at which the sensor stops tracking when it is lifted from its surface to avoid unwanted cursor movement. You may assign different values to the lift-off and landing distances by selecting the Enable Asymmetric Cut-Off.

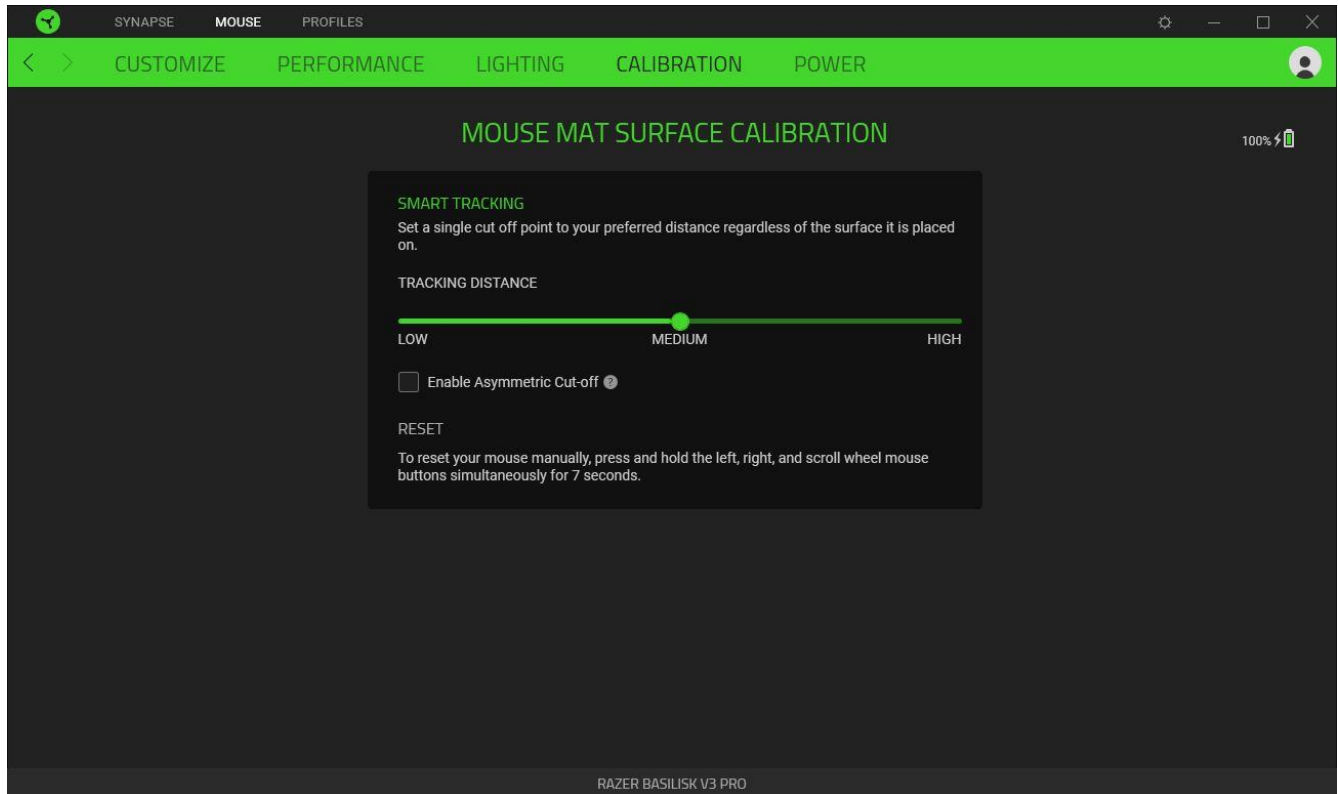

Power

The Power subtab allows you to manage your device's energy consumption when running on batteries. You can also set your device to enter sleep mode when idle for a certain amount of time.

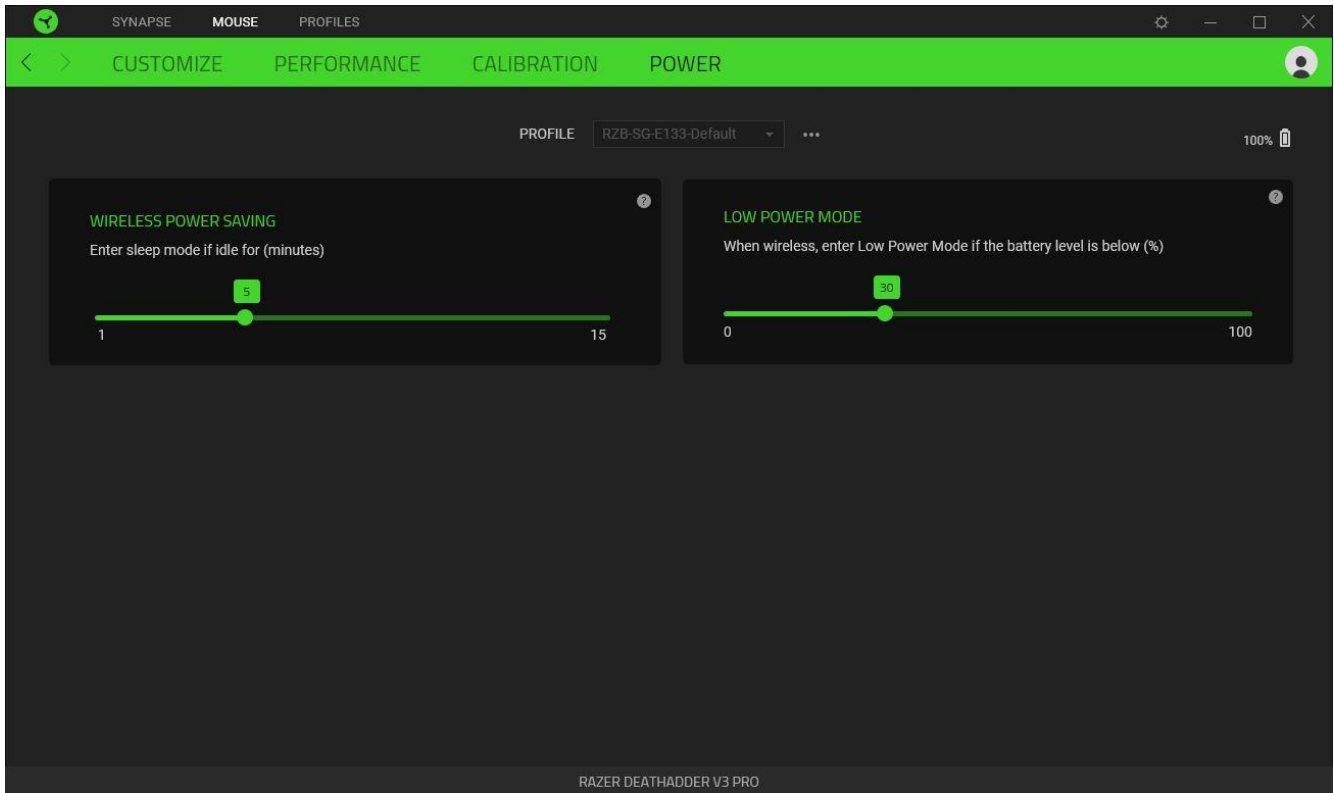





PROFILES TAB

The Profiles tab is a convenient way to manage all your profiles and link them to your games and applications.

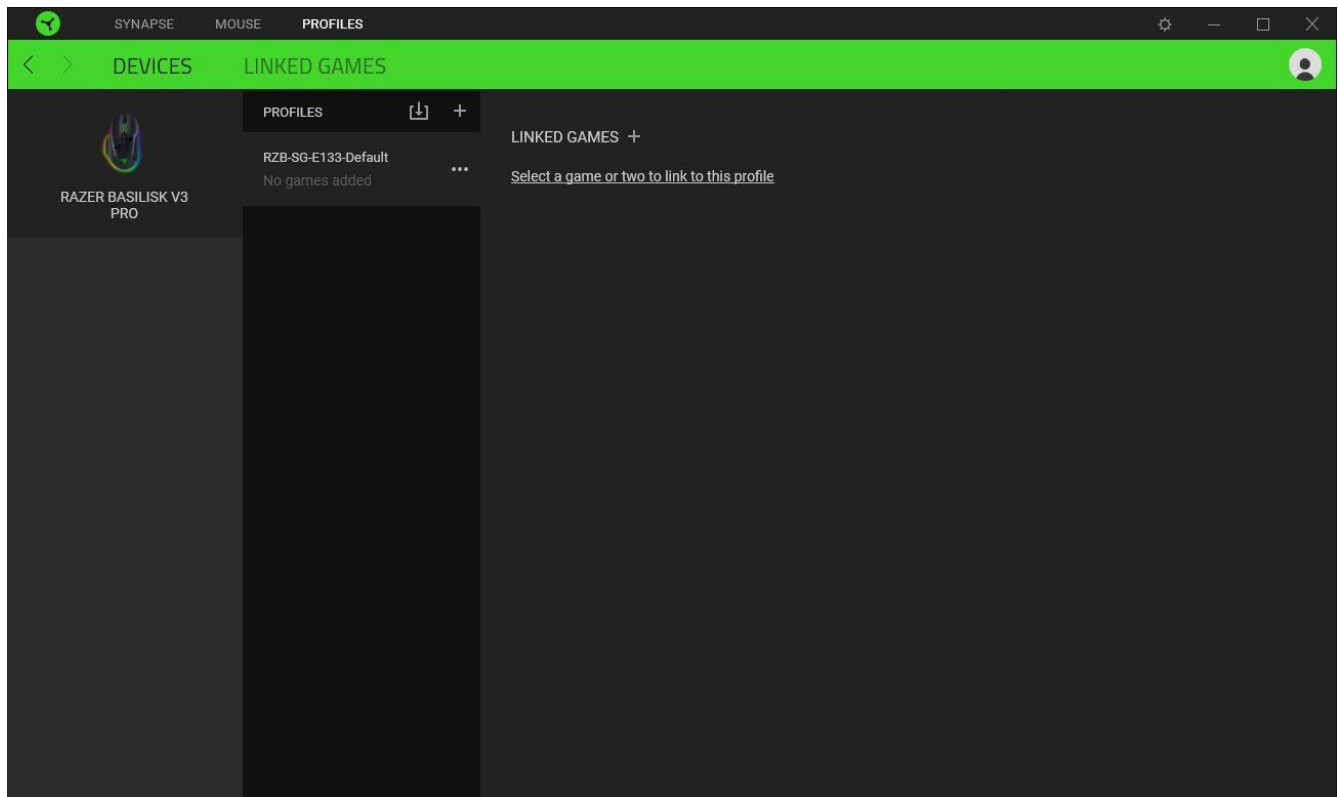
Devices

View which games are linked to each device's profiles or which Chroma Effect is linked to specific games using the Devices subtab.



You can import Profiles from your computer or the cloud through the import button () or create new profiles within the selected device using the add button (). To rename, duplicate, export, or delete a profile, simply press the Miscellaneous button (). Each profile can be set to activate when you run an application using the Linked Games option.

Linked Games

The Linked Games subtab allows you to add games, view devices linked to games, or search for added games. You can also sort games based on alphabetical order, last played, or most played. Added games will still be listed here, even if they are not linked to a Razer device.

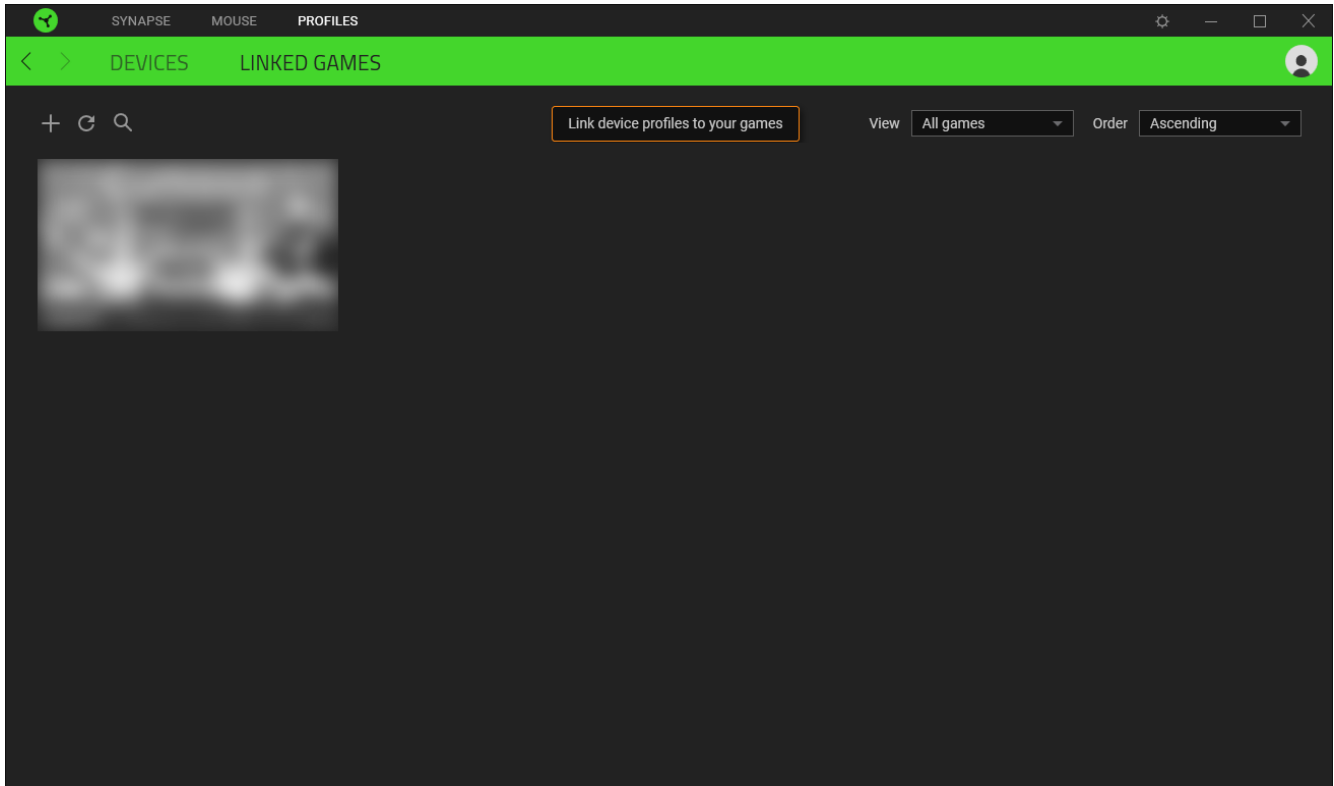

To link games to connected Razer devices or Chroma Effects, simply click on any game from the list, and then click **Select a device and its profile to launch automatically during gameplay** to select the Razer device or Chroma Effect it will link with. Once connected, you may click the Miscellaneous button (●●●) of the corresponding Chroma Effect or device to select a specific Chroma Effect or profile.

SETTINGS WINDOW

The Settings window, accessible by clicking the (⚙️) button on Razer Synapse, enables you to configure the startup behavior and display language of Razer Synapse, view the master guides of each connected Razer device, or perform a factory reset on any connected Razer device.

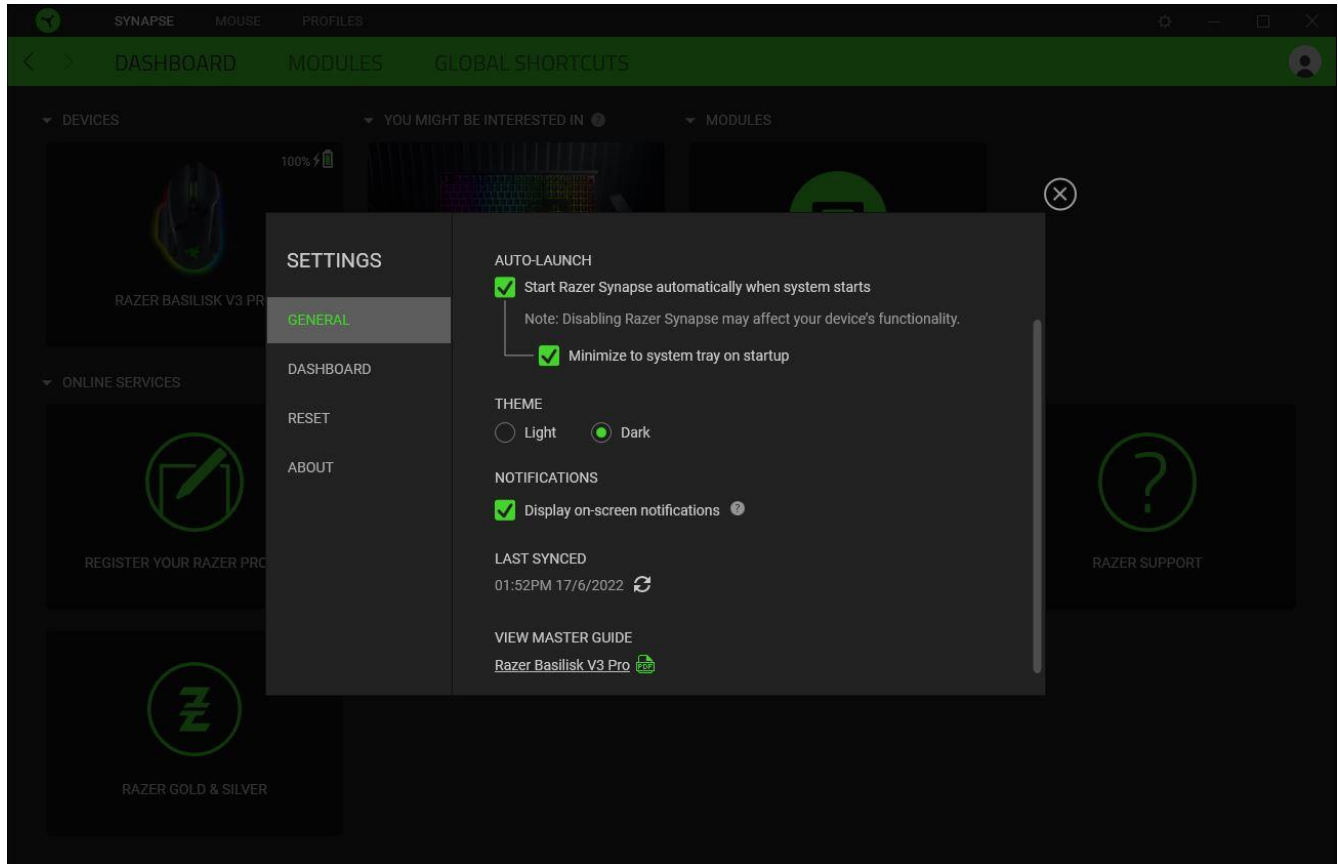

General tab

The General tab lets you change the software's display language, startup behavior, theme, and on-screen notifications display. You may also manually sync your profiles to the cloud (↻) or view the master guide of all connected Razer devices and installed modules.

Dashboard tab

Use the Dashboard tab to customize which Razer device recommendations based on your setup, and the games you play will appear on the Dashboard.

Reset tab

The Reset tab allows you to perform a factory reset on all connected Razer devices with on-board memory and/or reset Razer Synapse tutorials to acquaint yourself again with Razer Synapse's new features on its next launch.

 *All profiles stored on the selected device's on-board memory will be erased when you reset a Razer device.*

About tab

The About tab displays brief software information and copyright statement, and provides relevant links for its terms of use. You may also use this tab to check for software updates, or as quick access to Razer's social communities.

8. SAFETY AND MAINTENANCE

SAFETY GUIDELINES

To achieve maximum safety while using your Razer Basilisk V3 Pro we suggest that you adopt the following guidelines:

Should you have trouble operating the device properly and troubleshooting does not work, unplug the device and contact the Razer hotline or go to support.razer.com for support.

Do not take apart the device and do not attempt to operate it under abnormal current loads. Doing so will void your warranty.

The Razer Basilisk V3 Pro requires a USB connection that can supply sufficient power to charge the device. The charging process may be affected when connecting to a non-powered USB hub or non-powered USB, mostly found on keyboards and peripherals.

Keep the device away from liquid, humidity, or moisture. Operate the device only within the specific temperature range of 0°C (32°F) to 40°C (104°F). Should the temperature exceed this range, unplug and/or switch off the device to stabilize the temperature to an optimal level.

COMFORT

Research has shown that long periods of repetitive motion, improper positioning of your computer peripherals, incorrect body position, and poor habits may be associated with physical discomfort and injury to nerves, tendons, and muscles. Below are some guidelines to avoid injury and ensure optimum comfort while using your Razer Basilisk V3 Pro.

- Position your keyboard and monitor directly in front of you with your mouse next to it. Place your elbows next to your side, not too far away, and your keyboard within easy reach.
- Adjust the height of your chair and table so that the keyboard and mouse are at or below elbow-height.
- Keep your feet well supported, posture straight and your shoulders relaxed.
- During gameplay, relax your wrist and keep it straight. If you do the same tasks with your hands repeatedly, try not to bend, extend or twist your hands for long periods.
- Do not rest your wrists on hard surfaces for long periods. Use a wrist rest to support your wrist while gaming.
- Do not sit in the same position all day. Get up, step away from your desk and do exercises to stretch your arms, shoulders, neck, and legs.

If you experience any physical discomfort while using your mouse, such as pain, numbness, or tingling in your hands, wrists, elbows, shoulders, neck, or back, please consult a qualified medical doctor immediately.

MAINTENANCE AND USE

The Razer Basilisk V3 Pro requires minimum maintenance to keep it in optimum condition. Once a month, we recommend you unplug the device from the computer and clean it using a soft cloth or cotton swab to prevent dirt buildup. Do not use soap or harsh cleaning agents.

To get the ultimate experience in movement and control, we highly recommend a premium mouse mat from Razer. Some surfaces will cause undue wear on the feet requiring constant care and eventual replacement.

Do note that the sensor of the Razer Basilisk V3 Pro is 'tuned' or optimized, especially for the Razer mouse mats. This means that the sensor has been tested extensively to confirm that the Razer Basilisk V3 Pro reads and tracks best on Razer mouse mats.

BATTERY WARNING

The Razer Basilisk V3 Pro contains a Li-ion rechargeable battery. In general, the life expectancy of such batteries is dependent upon usage. If you suspect that the Li-ion rechargeable battery inside the Razer Basilisk V3 Pro may be drained (has a low charge), try charging it.

Caution: Do not open, mutilate, or expose to conducting materials (metal), moisture, liquid, fire, or heat. Doing so may cause batteries to leak or explode, resulting in personal injury. Battery life varies with usage.

9. LEGALESE

COPYRIGHT AND INTELLECTUAL PROPERTY INFORMATION

©2022 Razer Inc. All rights reserved. Razer, the triple-headed snake logo, Razer logo, "For Gamers. By Gamers.", and "Razer Chroma" logo are trademarks or registered trademarks of Razer Inc. or affiliated companies in the United States and other countries. All other trademarks are the property of their respective owners.

The Bluetooth® word mark and logos are registered trademarks owned by Bluetooth SIG, Inc., and any use of such marks by Razer is under license.

Windows and the Windows logo are trademarks of the Microsoft group of companies.

Razer Inc. ("Razer") may have copyright, trademarks, trade secrets, patents, patent applications, or other intellectual property rights (whether registered or unregistered) concerning the product in this guide. Furnishing of this guide does not give you a license to any such copyright, trademark, patent or other intellectual property right. The Razer Basilisk V3 Pro (the "Product") may differ from pictures whether on packaging or otherwise. Razer assumes no responsibility for such differences or for any errors that may appear. Information contained herein is subject to change without notice.

LIMITED PRODUCT WARRANTY

For the latest and current terms of the Limited Product Warranty, please visit [razer.com/warranty](https://www.razer.com/warranty).

LIMITATION OF LIABILITY

Razer shall in no event be liable for any lost profits, loss of information or data, special, incidental, indirect, punitive or consequential or incidental damages, arising in any way out of distribution of, sale of, resale of, use of, or inability to use the Product. In no event shall Razer's liability exceed the retail purchase price of the Product.

GENERAL

These terms shall be governed by and construed under the laws of the jurisdiction in which the Product was purchased. If any term herein is held to be invalid or unenforceable, then such term (in so far as it is invalid or unenforceable) shall be given no effect and deemed to be excluded without invalidating any of the remaining terms. Razer reserves the right to amend any term at any time without notice.