

MID CITY ENGINEERING

1322 W WALTON ST, CHICAGO, IL 60642 | T: (312) 421-1114 • F: (312) 421-5558

SmartKey Starter® Installation Manual: ML '14-'15, GL '14-'15, CLA & GLA '15-'19, GLS '16-'19 GLE '16-'19, G Wagon '16-'18, Infiniti Q30 & QX30 '16-'19 SKSNG166D4

Installation for the **SKSNG166D4** involves the following procedures. The procedures are defined in this manual and sorted into sections. The sections are as follows:

- 1) Jumper modification on EIS (Electronic Ignition Cylinder)
- 2) T-Harness behind the ignition cylinder
- 3) Keyless Go harness installation
- 4) Key box installation
- 5) Smart phone control and / or RF remote connections (*optional*)
- 6) Options settings (*optional*)

Note: Page 23 of this manual contains resources including website and contact information, a link to our troubleshooting guide, and more.

Tools needed:

T-20 Driver

Drill

E14 Torx Socket - ML only, Keyless Go only

T45 Torx Bit- Keyless Go only

T40 Torx Bit- Keyless Go only

Panel Removal Tool- Keyless Go only

Pick tool- Keyless Go only

Section 1: EIS Jumper Modification

View and download EIS mod. instructional video here: <https://goo.gl/ALiKb1>

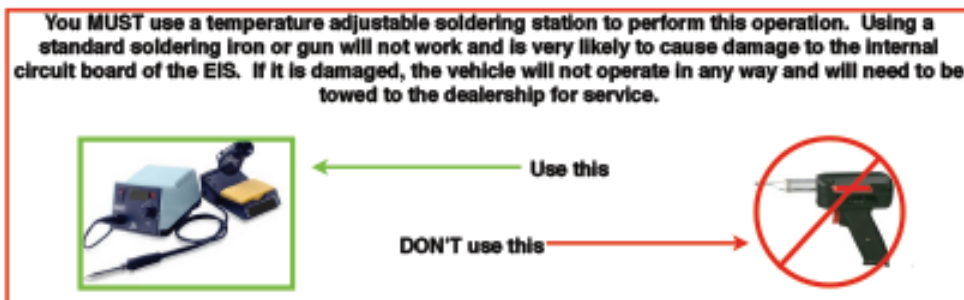

This jumper is a requirement for all SKSNG166D4 installations to allow full plug and play of the Smartkey Starter®. If you are not comfortable with fine soldering on a circuit board do not attempt to learn using these instructions. Damage to the EIS is possible if jumper installation is not done properly. Please contact Midcity Engineering if you would like to have the work done for you.

CAUTIONEIS is an electrostatic sensitive device.
To prevent damage, use proper grounding and handling techniques.**Note: for EIS removal, go to section 2 and follow instructions for T-Harness Installation**

1. Remove three (3) T-8 screws from the rear of the EIS case. Remove them completely from the case, do not simply loosen them and leave them in place (see picture).
2. Using the pry tool, release the clips on one side of the EIS case while lifting up on the back panel.
3. Work around the EIS until all clips are released and the rear cover is removed.
4. Gently remove the circuit board from the front half of the case.
5. Locate the empty pin 8 in the set of 8 pins (see picture). The pin locations are marked inside the plug housing on the rear panel of the EIS that was removed in step 3.
6. Using the soldering station, fill the empty solder pad at pin 8 with solder. Do not over fill, just enough to cover the opening.
7. Using tweezers, insert the extra EIS pin into the pin 8 solder pad while heating the opening with the soldering station.
Make sure the pin is parallel with the rest of the pins and it is fully inserted.
8. Remove heat from the pin and verify that it is properly held in place.
9. Tin each end of the short length of 30awg wire.
10. Solder one end of the wire to the pin 8 that was installed in steps 6-8. This wire should be attached at the very base of the pin closest to the circuit board.
11. Solder the other end of the wire to the solder point shown in the picture below. It is the first solder point next to the white optical sensor on the same side of the board as the pin that was just installed in steps 6-8.
12. Secure the wire to the board so that it won't get caught up when the EIS is reassembled or get in the way of any moving parts. See picture below for best placement.
13. Using a Multimeter, you can test your work by probing the test points as shown in the picture below to verify proper continuity. In other words, you should have continuity between the new pin 8 and the tab on the optical sensor.
- 14)Put the circuit board back into the front of the EIS housing.
15. Snap the rear panel in place making sure the new pin fits properly through the pin slot.
16. Reinstall the three (3) T-8 screws.
17. Snap in the white screw cap where the sticker was broken to access the screw.

See reference pictures for EIS modification on pages 3 and 4.

Attention: Video of EIS modification can be found here: <https://goo.gl/ALiKb1>



Original EIS removed from vehicle

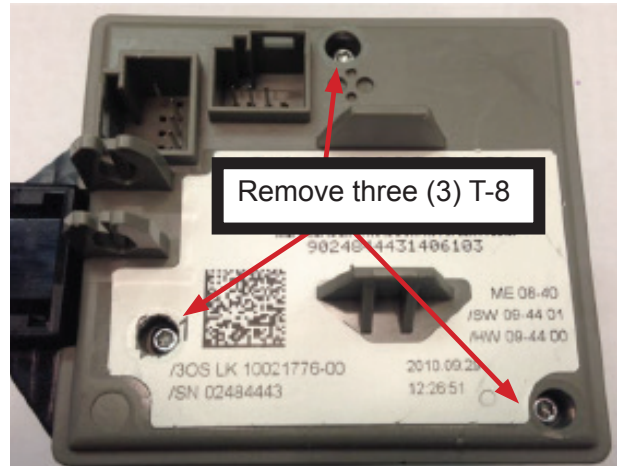

Remove three (3) T-8

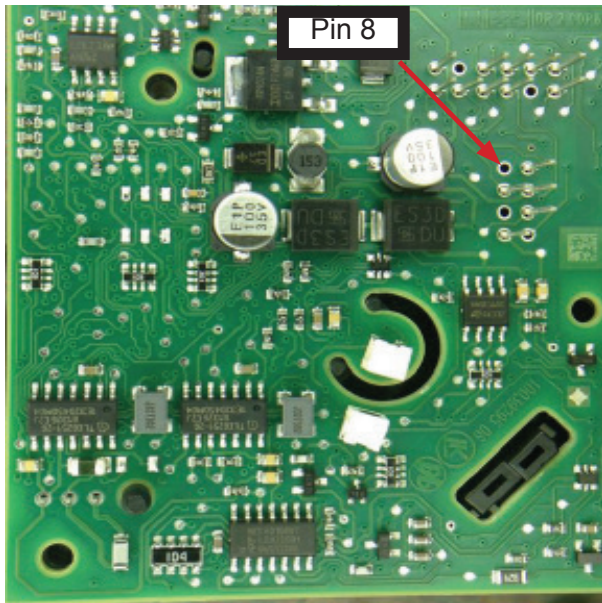

Circuit board removed from case

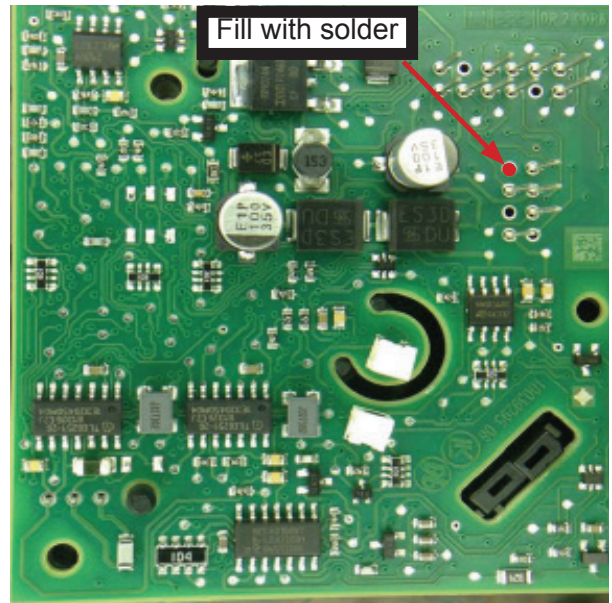

Fill Pin 8 location with solder before inserting pin

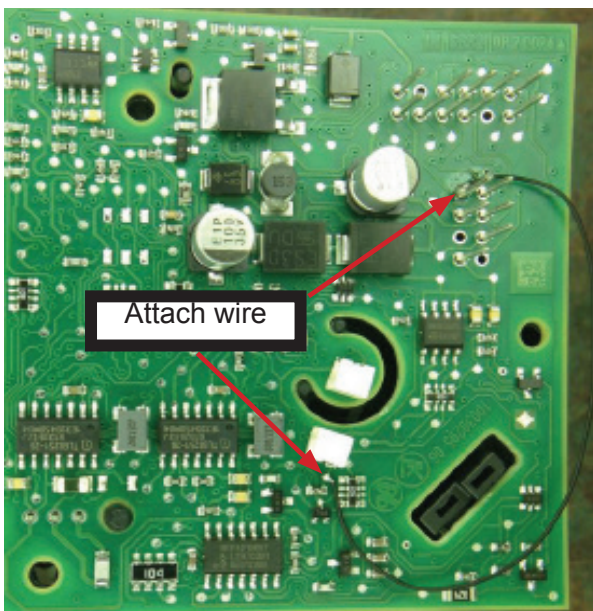

Pin inserted and wire soldered

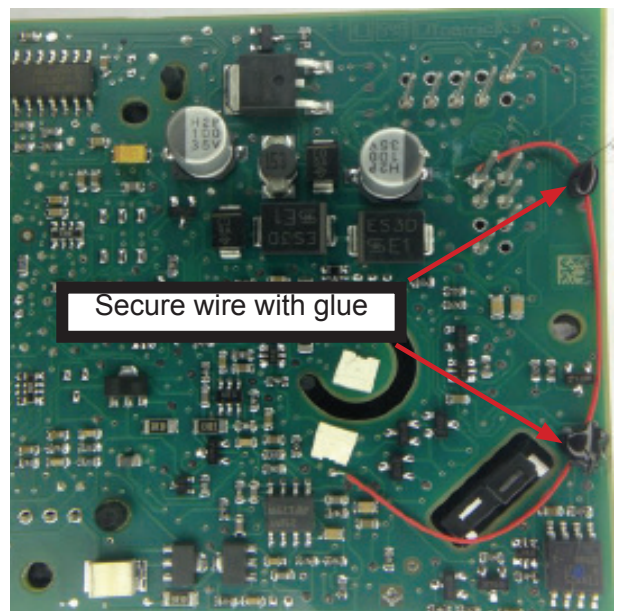

Wire secured in place with glue

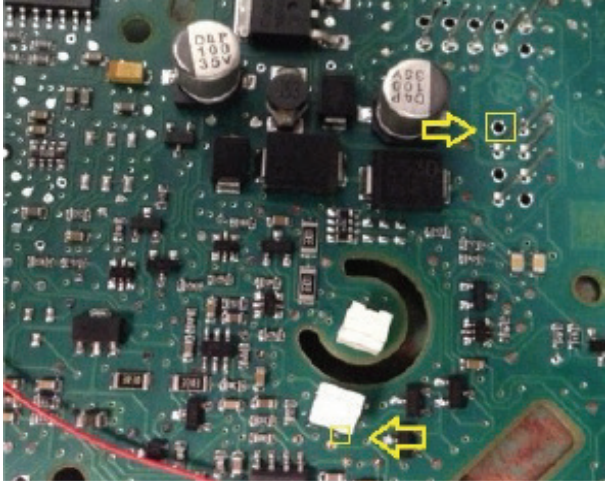

Test points after jumper is installed



Re-assembled with screw cap in place

View and download EIS mod. instructional video here: <https://goo.gl/ALiKb1>

If you have any questions about the modification procedure or would like to send EIS to Mid City Engineering for modification free of charge, please contact Mid City Engineering at 312-421-1114 or sales@midcityengineering.com

Section 2: T-Harness Installation (refer to wiring diagram on page 9)

ML, GL, GLE and GLS

1. Remove three (3) T-20 screws from the driver's under dash panel.
2. Lower dash panel down and move air vent from the clips that hold it in place.
3. Reach up to the rear of the EIS. There are two retaining clips. One on the top and one on the bottom of the EIS.
4. Grasp the wiring harness while squeezing the retaining clips together and push from the front to remove the EIS.
5. Pull the EIS with harness attached out of the dash to access the wiring.
6. Un-plug both plugs (blue and green) from the EIS.
7. Connect the Smartkey Starter® harness in line with the plugs and connect the opposite end into the rear of the EIS (**see diagram on page 9**).
8. Once ALL connections are secured, make sure the the SmartKey Starter® module has power (indicated by LEDs on module). Note: you may need to hit 'unlock' on the OEM fob for LEDs to illuminate.

9. Start the vehicle **with the push button** to verify your work. If the vehicle starts and runs, you've made all the connections correctly.

10. Run engine for 30 seconds

11. Shut the vehicle off.

12. Push the panic button once on the OEM remote key fob to test the Smartkey Starter® . **Note: Push button must be inserted in ignition in order for the SK-SNG166D4 to work.**

13. Once you are satisfied with its operation, shut down the Smartkey Starter® by pushing the panic button once.

14. Locate mounting location for the module away from any moving parts or heat sources. **Note: do not mount the module to its final location until the the key box installation is complete (section 5) and the remote start and any external devices are tested.**

15. Place warning label on OBD access panel

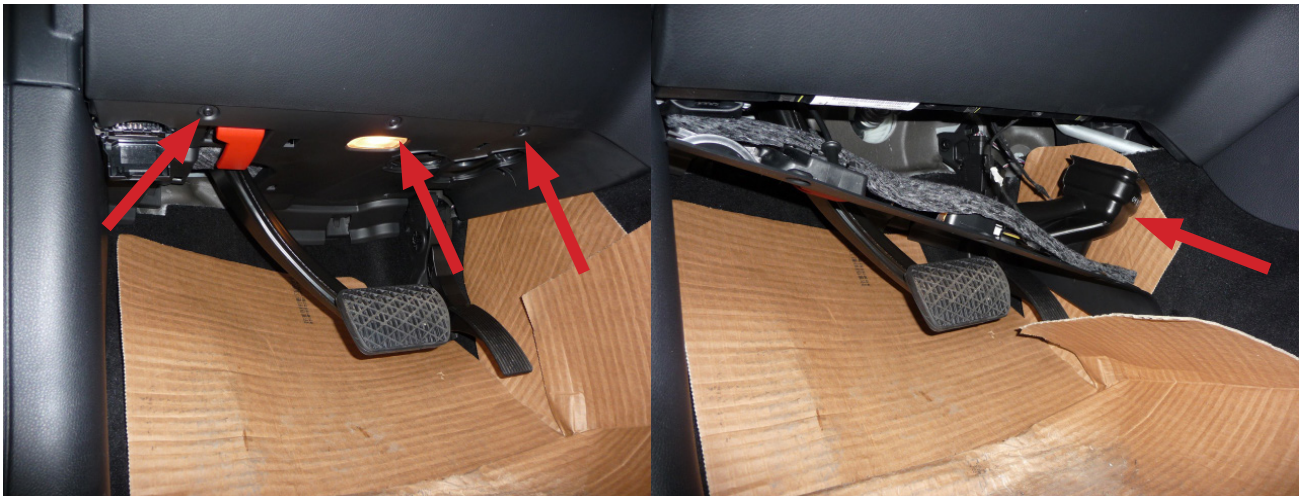

Remove (3) T-20

Lower panel and move vent



EIS Removed

T-Harness Installed

CLA, GLA, Q30 and QX30

1. Lower the steering column and extend it to its maximum.
 2. Gently pry out on the bezel around the gauges and release all the clips.
 3. Un-snap the top rear half of the steering column shroud by pulling up- starting at the part closest to the firewall.
 4. Un-plug the HVAC sensor from the bottom right of the trim bezel and set the bezel with column cover aside in a safe place.
 5. You now have access to reach the rear of the EIS to make the T-harness connections as shown in the T-Harness wiring diagram. Additionally, you can remove the gauge cluster by removing two (2) T-20 from the bottom and releasing the clips on top. This may free up additional space for accessing the EIS and will provide a place to mount the Smartkey Starter® module behind the gauge cluster.
 6. Reach in the behind the EIS and unplug the two plugs, one (1) green or tan plug and one (1) blue plug, and un-plug them.
 7. Connect the Smartkey Starter® harness in line with the plugs and connect the opposite end into the rear of the EIS (*see diagram on page 9*)
- Note: A subset of CLA/GLA/Q30/QX30 will have twelve (12) pin tan plugs instead of green and will have an alternate keying. In order to accomodate this, shave the small keys from the top of the twelve (12) pin green plug on the SmartKey Starter® T-Harness (see pictures on next page for reference).**
8. Route the Smartkey Starter® harness to a location where the starter can be mounted away from heat and moving parts.
 9. Connect the Smartkey Starter® to the T-harness
 10. Once ALL connections are secured, make sure the the SmartKey Starter® module has power (indicated by LEDs on module) note: may need to hit
 11. Start the vehicle **with the push button** to verify your work. If the vehicle starts and runs, you've made all the connections correctly.
 12. Run engine for 30 seconds
 13. Shut the vehicle off.
 14. Push the panic button once on the OEM remote key fob to test the Smartkey Starter® . **Note: Push button must be inserted in ignition in order for the SK-SNG166D4 to work.**
 15. Push the panic button on once on the OEM remote key fob to test the Smartkey Starter® *Note: may need to hit 'lock' or 'unlock' first if KG harness is not yet hooked up.*
 16. Once you are satisfied with its operation, shut down the Smartkey Starter® by pushing the panic button once.
 17. Locate mounting location for the module away from any moving parts or heat sources. **Note: do not mount the module to its final location until the the key box installation is complete (section 5) and the remote start and any external devices are tested.**
 18. Place warning label on OBD access panel

CLA, GLA, Q30 and QX30 contd.



Begin to release bezel



Remove steering column cover



Remove bezel and unplug HVAC sensor

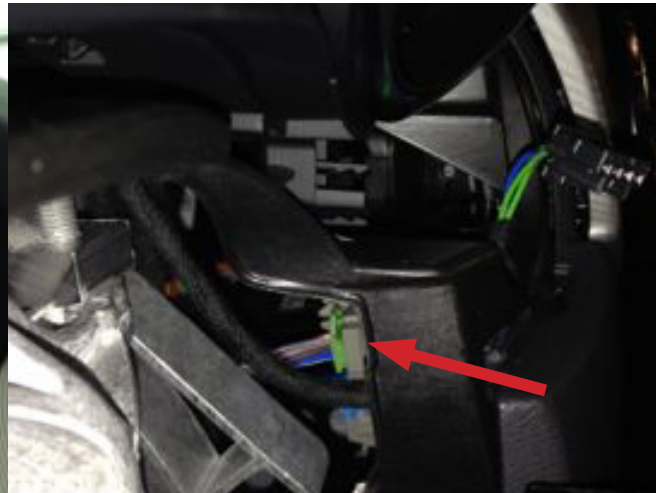

EIS connections

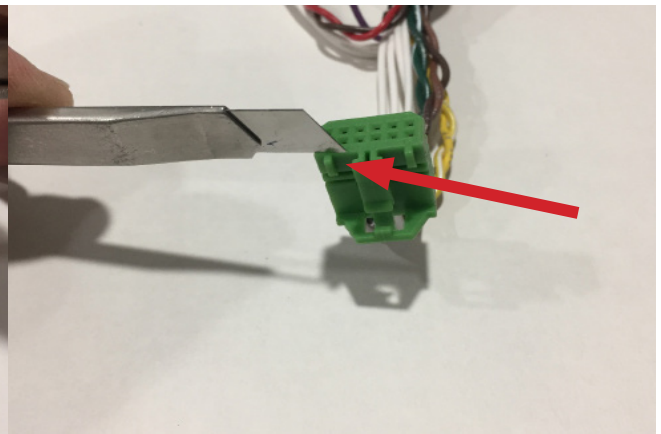
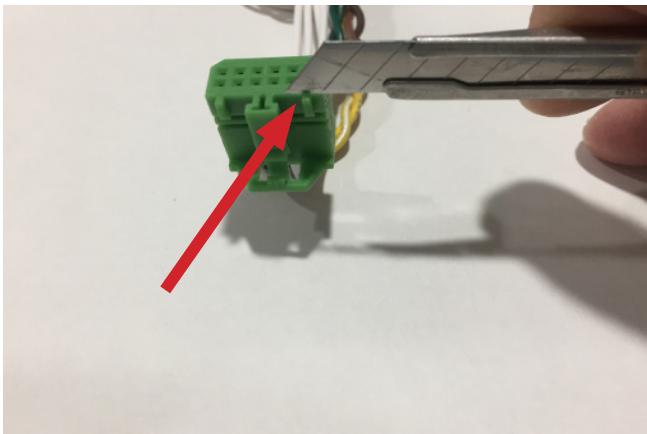

If tan twelve pin plug does not fit, remove small keys from plugs using razor blade (**subset of CLA/GLA/Q30/QX30 with alternate keying**)

G Wagon (Note: SKSNG166D4 only compatible with 2016-2017 G Wagon if OEM Keyless start retrofit is installed first. Call 312-421-1114 for details on adding OEM Keyless Start)

1. Lower the steering column and extend it to its maximum.
2. Grasp the plastic trim below the instrument cluster and pull toward you.
3. Continue removing the boot around the steering column and pull it away from the dash as far as it will go.
4. Reach in the behind the EIS and unplug the two plugs, one (1) green plug and one (1) blue plug, and un-plug them.
5. Connect the Smartkey Starter® harness in-line with the plugs and connect the opposite end into the rear of the EIS (**see diagram on page 9**)
6. Route the Smartkey Starter® harness to a location where the starter can be mounted away from heat sources and moving parts.
7. Connect the Smartkey Starter® to the T-harness.
8. Once ALL connections are secured, make sure the the SmartKey Starter® module has power (indicated by LEDs on module).
9. Start the vehicle **with the push button** to verify your work. If the vehicle starts and runs, you've made all the connections correctly.
10. Run engine for 30 seconds
11. Shut the vehicle off.
12. Push the panic button once on the OEM remote key fob to test the Smartkey Starter® . **Note: Push button must be inserted in ignition in order for the SK-SNG166D4 to work.**
13. Once you are satisfied with its operation, shut down the Smartkey Starter® by pushing the panic button once.
14. Locate mounting location for the module away from any moving parts or heat sources. **Note: do not mount the module to its final location until the the key box installation is complete (section 5) and the remote start and any external devices are tested.**
15. Place warning label on OBD access panel



Remove steering wheel boot

EIS plug location at back of EIS

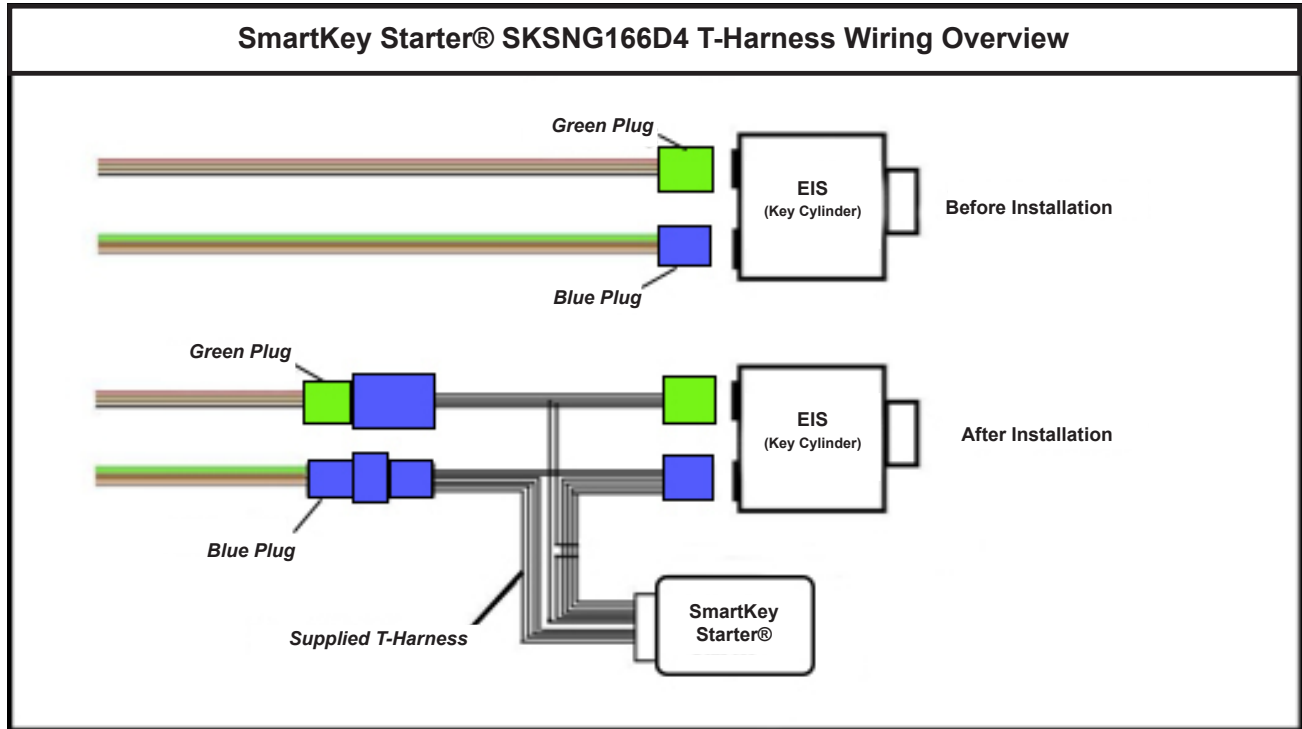

 **DO NOT MOUNT THE MODULE NEAR ANY HEAT SOURCES IN THE VEHICLE. SPECIFIC LOCATIONS TO AVOID ARE THE HEATER CORE AND THE TRANSMISSION TUNNEL.**

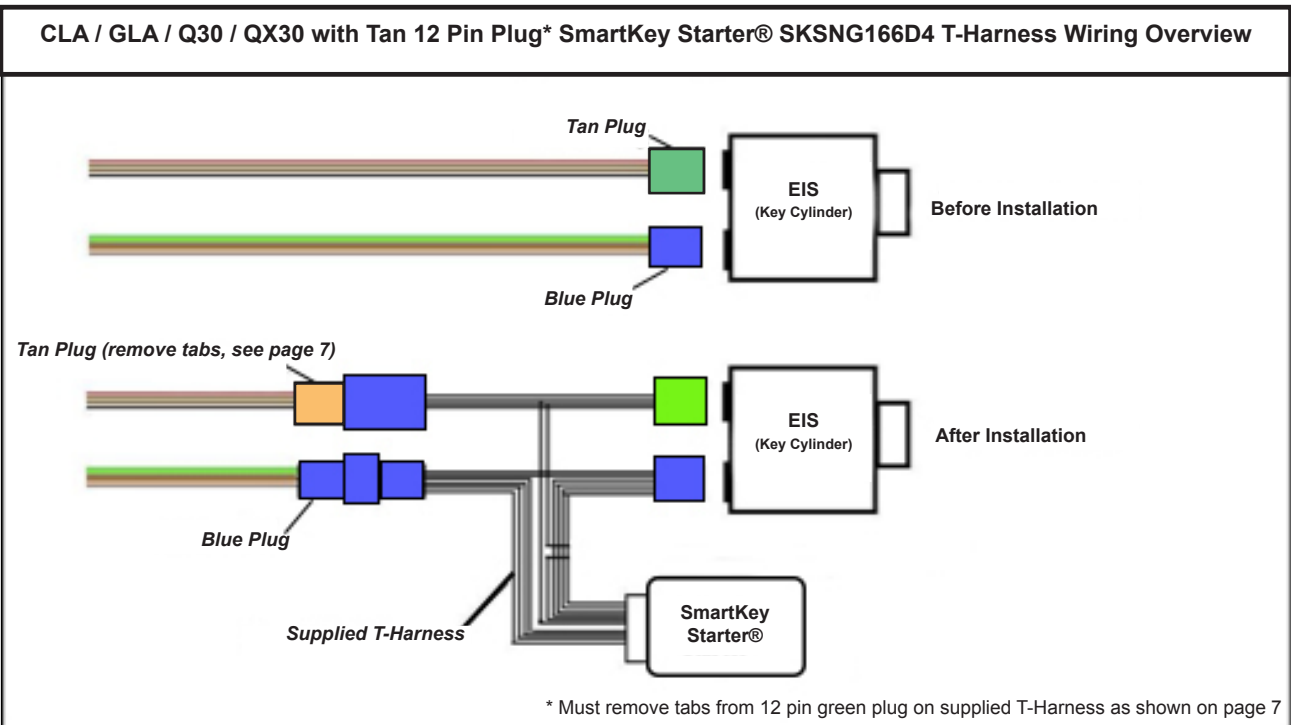

Section 3: Keyless Go Jumper Harness (KG20166) Installation

ML and GLE

1. Remove the driver's rear door sill plate.
2. Fold the driver's rear seat bottom forward.
3. Remove two (2) bolts holding the seat bottom to the floor.
4. Remove the driver's side rear seat bottom from the vehicle.
5. Remove one (1) bolt holding the center seat back bracket and (1) bolt holding the seat belt.
6. Fold the rear driver's side seat back down.
7. Pry up the covers for the tie down loops in the cargo area.
8. Remove the bolts from each tie down and remove the hooks from their mounts.
9. Remove the cargo cover.
10. Remove the foam inserts directly behind the rear seats.
11. Remove two (2) additional bolts that hold the driver's side rear seat back.
12. Un-clip the wire harness that is clipped to the driver's side rear seat bracket.
13. Flip the driver's side rear seat back into the cargo area making sure the wire harness doesn't get pinched or pulled beyond its limit.
14. Pull up the carpet to access the KeylessGo module on the floor.
15. Route the supplied KeylessGo harness (KG20166) from the Smartkey Starter® module to the rear seat area.
16. Un-plug the main connector from the KeylessGo module.
17. Remove the shroud from the main KeylessGo connector.
18. Remove the brown and brown/red wires from the KeylessGo plug. Make a note of the wire locations in the plug.
19. Insulate the ends of the removed wires.
20. Using the supplied W166 KG jumper harness (KG20166), populate the brown and brown/red wires into the locations where the factory wires were removed.
21. Re-install the shroud for the KeylessGo main plug and plug it back in.
22. Close all doors, hood and hatch to test the remote start.
23. Remote start the vehicle. If everything is connected properly, you should be able to lock and unlock the vehicle using the touch sensors on the door handles while the remote start is running.
24. Unlock and enter the vehicle. Push the start button one time. The lights should flash three times to confirm key take over.
25. Turn off the vehicle.
26. Secure the KG20 harness to existing wiring.
27. Lay the carpet back in place.

28. Re-mount the seat back and seat belt. Make sure the wire harness is clipped back into place.
29. Fold the seat back down and install the foam inserts and the cargo cover.
30. Re-install the cargo tie down hooks.
31. Fold the seat back up.
32. Re-install the seat bottom and bolt it in place.
33. Re-install the sill plate.



Remove sill plate

Unbolt seat bottom



Seat bottom removed

Unbolt seat back

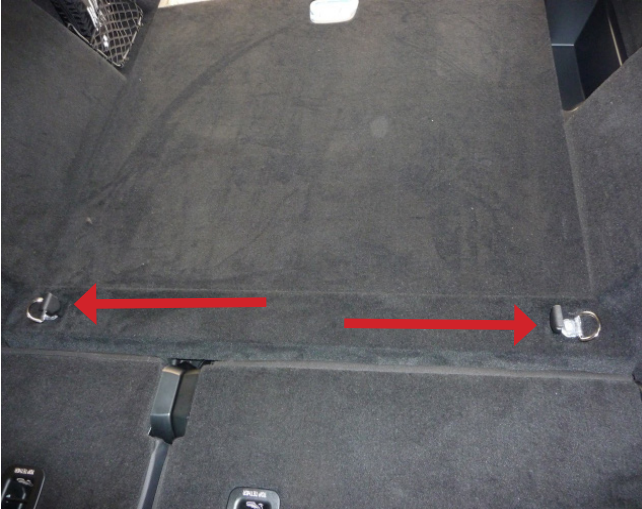

Unbolt Cargo tie downs



Remove cargo cover



Remove foam inserts



Unbolt seat bracket

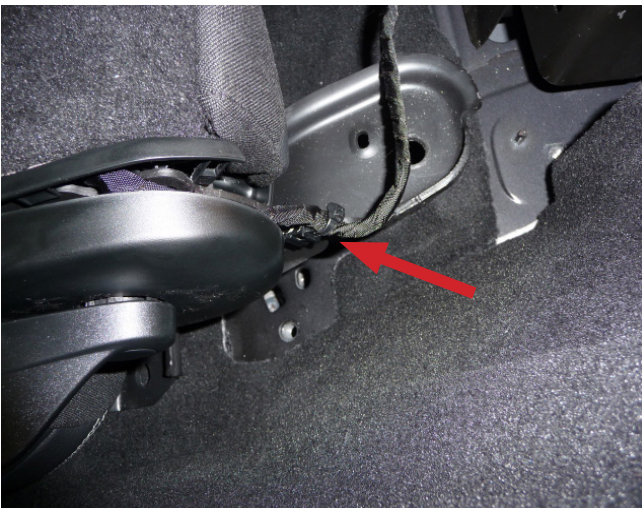

Unclip wire harness



Flip seat back into cargo area



Pull up carpet



Unplug KeylessGo module

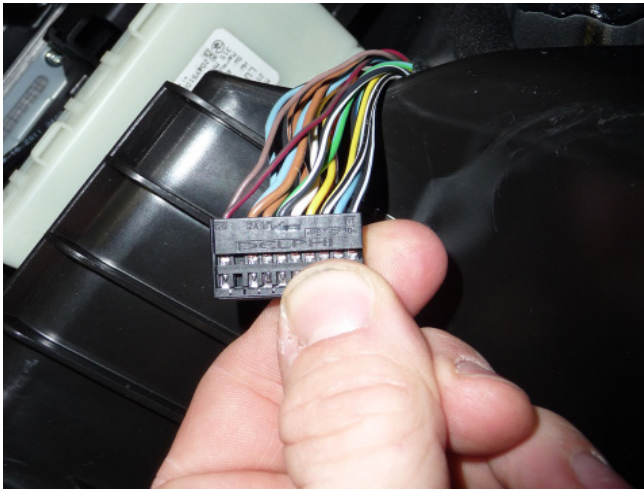

Shroud removed from plug

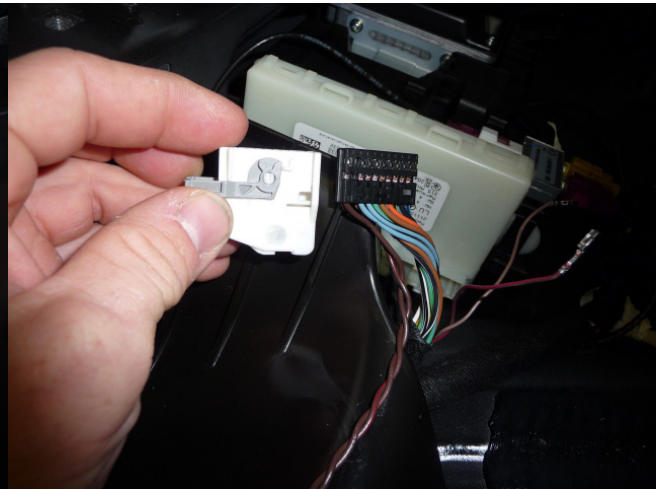

New pins installed, reinstall shroud



Plug Keyless Go module in



Note: 2014+ w166 KG module has slightly different plug configuration (pictured)

GL and GLS

1. Remove driver's rear door sill.
2. Fold driver's middle row seat all the way forward.
3. Remove torx bolt holding seat belt to rear side panel.
4. Pull back weather strip on the back side of the rear door opening.
5. Remove (1) T-30 torx from inside the rear retractable cover mount.
6. Pop side panel partially out.
7. Route the 166 KG adapter to the rear side panel area.
8. Reach in and unplug connector on KG module (see picture).
9. Remove the shroud from that connector
10. Remove the brown and brown/red pins from the black connector making a note of their position
11. Install the pins from the 166 KG adapter into the spots where the factory wires were removed.
12. Reinstall the shroud for that plug.
13. Re-install the plug into the module.
14. Pop the side panel back into place.
15. Re-install (1) T-30 Torx and cosmetic cover.



Remove door sill



Remove seat belt



Remove screw cover



Remove T-30



Pull back weather strip



Pop out side panel



Remove white plug (*note: see alternative module configuration on [next page](#)*)



Plug removed



Shroud removed



KG harness properly installed into plug



Note: 2014+ w166 KG module has slightly different plug configuration (pictured)

CLA, GLA, Q30 and QX30

1. Remove carpeting and access wire trough in drivers side cargo area
2. Route the KG20166 adapter to the trunk area
3. Reach in and unplug connector on KG module (see picture).
4. Remove the shroud from that connector
5. Remove the brown and brown/red pins from the black connector making a note of their position
6. Install the pins from the KG jumper harness (KG20166) adapter into the spots where the factory wires were removed.
7. Reinstall the shroud for that plug.
8. Re-install the plug into the module.

Note: there is an alternative KG jumper harness installation procedure at the CAN distribution block behind the instrument cluster. Follow procedure in video here https://youtu.be/zUia4us_19U (connections must be hard-wired)



Remove carpeting and access wire trough



Keyless Go module

Section 4: Key box installation

1. Remove the metal key blade from the Smartkey, if present.
2. Remove the battery cover using the flat blade screwdriver by pressing on the tab inside the key (see picture).
3. Remove the battery from the key.
4. Insert the battery emulator with the arrow facing the tip of the key by angling the positive side down into the key first.
5. Push the battery emulator fully into the battery slot.
6. Insert the key into the key box with the buttons facing down on the foam.!
7. Put the lid on the box and secure it with the four (4) screws provided using the #1 philips.
8. Connect the 2 pin plug to the 2 pin port on the SmartKey Starter labeled® 'KEY'



Remove battery cover



Remove battery



Battery removed



Insert battery emulator- bottom first



Push battery emulator fully into place



Key positioning in box

Section 5: External Device Connections

The Smartkey Starter® NG module allows for multiple external devices (such as RF remotes or telematics controllers) to be connected without additional programming.

Compustar Drone Connection

1. Connect the Black data cable from the Drone to the Black port labeled 'DRONE' on the SmartKey Starter®

DO NOT USE BLUE PORT FOR DRONE CONNECTION. DRONE DATA CABLE MUST PLUG INTO BLACK PORT MARKED RS232 OR DRONE AS INDICATED ON THE BOTTOM LABEL

2. Verify that the Drone has power and cellular connection. **The blue LED on the Drone will indicate power and connection to SKS module. Once the Drone has a cellular connection, the blue LED will flash slowly.**

3. Activate the Drone using the Drone Mobile smart phone application or www.dronemobile.com (see picture below for hardware selection)



Compustar Drone connection

D
STEP 5
☰

Select Hardware

Remote Start, Security or Combo
(Compustar, Arctic Start, FTX etc.)

Select Installed Features

Siren

Shock Sensor

Temp Sensor

Compustar Drone activation hardware selection

Compustar RF Remote Connection and Programming Instructions

The SmartKey Starter® NG module has two (2) blue Compustar antenna ports. To connect Compustar RF antenna, use corresponding antenna port on the SKS NG module (either six (6) pin blue plug or four (4) pin blue plug).

NOTE: Compustar AM Remotes are not supported

To program any compatible Compustar remote control, complete the above installation steps and verify standard operation. ***Read entire procedure prior to attempting to program remotes- programming procedure must be completed in under 10 seconds.***

1. If the vehicle is equipped with a Push start button on the dash (push buttons in the gear selector lever do not come out in this manner, nor are they applicable in this case), grasp the button and pull it out of the ignition switch.
2. Insert the key in the ignition switch and cycle it five (5) times from 'OFF' to (only one click in the clockwise direction) and back to off. The lights will flash once.
3. Press 'lock' or button 1 on the remote control and the lights will flash to confirm programming. Up to four (4) Compustar remotes can be programmed to one SKS unit.
4. Once all remotes have been programmed, wait for a single light flash confirmation signifying the module has exited programming mode.
5. Verify the operation of the new remote.
6. Insert KeylessGo button back into ignition (if applicable) when finished.



Compustar RF remote antenna connection

Directed RF Remote Connection Instructions

The Smartkey Starter® is equipped with a (4) pin and a (3) pin connector

The (4) pin connector is designed to accept a D2D cable from an XL202 RF translator module to provide the ability for adding long range remotes and 2 way capability to the Smartkey Starter®.

There is no programming required for the module. The remotes need to be programmed to the XL202 which should have instructions provided with it.

Directed Smart Start Connection

1. Plug the three (3) pin ESP cable with the black plug directly into the three (3) pin white plug on the SmartKey Starter® NG module labeled 'Smart Start'

Note: If not using an XL202 for remotes, SmartStart unit power can be tapped from the D2D port of the NG module. To do this, remove and insulate the blue and green wires from the D2D connector on the SmartStart harness then connect to the white four (4) pin D2D port on the SmartKey Starter® NG module labeled 'D2D.'

If using XL202 for Directed remote connections, follow steps 2 and 3 for power and ground connections to the SmartKey Starter® T-Harness.

2. Power should be connected to any solid red wire on the top row (clip side) of the main harness.

3. Connect ground to any solid brown wire in the bottom row directly below the solid red wires on the SmartKey Starter® T-Harness.

NOTE: DO NOT CONNECT TO A BROWN WIRE TWISTED WITH A BROWN/RED STRIPE WIRE.



Directed XL202 connection

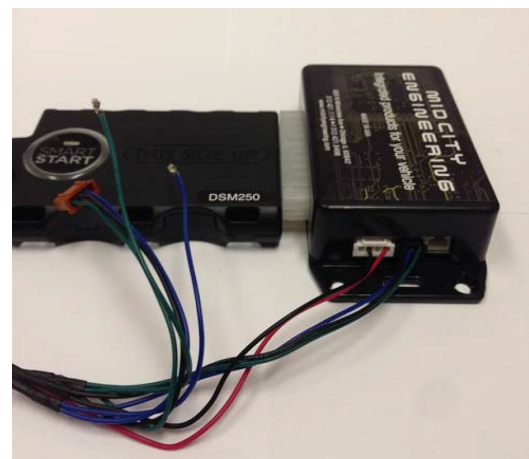

Directed SmartStart Connection

Section 4: Option Programming

Remote starter option programming is performed in the vehicle using the steering wheel controls. To perform option programming, first the vehicle must be in ACC (first position) and all the doors must be closed. The instrument cluster must be in the 'AUDIO' or 'RADIO' menu. The options menu will appear where the radio information typically appears. To access the menu, the 'MUTE' button on the steering wheel must be pressed for about 2 seconds until "REMOTE START: ON/OFF" appears on the cluster. This is the first option setting. "REMOTE START: ON" means the remote start is enabled. "REMOTE START: OFF" means that the remote start is disabled (valet mode). The remote start should be turned on before the vehicle is serviced. Once in the menu, press and release the 'MUTE' button to cycle through each option. The setting will save automatically after the menu times out. To scroll to the next menu option, press and release the 'VOL -' button on the steering wheel. To scroll up through the options, press and release the 'VOL +' button'

Option Settings Procedure

1. Get in driver seat and close all doors
2. Put vehicle in ACC
 - For Keyless Go vehicles (push button start), press push button once without foot on the brake
 - For non-Keyless Go vehicles (key start), insert key and turn to the first position
3. Using the arrows on the steering wheel, turn the instrument cluster to the 'AUDIO' or 'RADIO' setting
4. Press and hold the 'MUTE' button on the steering wheel for approximately 2 seconds until the "REMOTE START: ON/OFF" appears in the instrument cluster. This is the first menu option.
5. Use the 'VOL -' button on the steering wheel to scroll through the available option settings and use 'VOL +' to scroll back up through the option settings
6. When the desired option setting to change appears in the cluster, press and release the 'MUTE' button cycle through the available settings. When the desired setting is reached, either press and release the button automatically when the menu times out.

THERE IS A DEMO VIDEO OF THE MENU AND ALL AVAILABLE FEATURES HERE:

<https://youtu.be/zMvR-gKYGSw>

SmartKey Starter® Resources

For technical support, please refer to our SKSNG166D3 troubleshooting guide. You can view and download the troubleshooting guide here: <http://www.midcityengineering.com/troubleshooting-guides/>

Our SmartKey Starter® frequently asked questions page can be found here: <http://www.midcityengineering.com/smartkey-starter-faq/>

If you need further information or assistance, please contact Mid City Engineering at 312-421-1114 or send an email to sales@midcityengineering.com

SKS NG owners manual can be downloaded here: <https://goo.gl/V8kSZE>

Please refer to SKS NG owners manual for warranty information (link above)

SKS NG Soft Reset Procedure

This procedure will reset the SKS NG module, but not reset the options settings or memory. For full reset procedure, use options setting procedure.

1. Remove push to start button.
2. Insert key, but do not turn (see photo above).
3. Simultaneously press and release the 'OK' and 'MUTE' buttons on the steering wheel.
4. The parking lights should flash one time. The system is now reset.

Troubleshooting Diagnostic Flashes

If a failure occurs during remote start, the parking lights / mirror lights should flash between five (5) and ten (10) times. The number of light flashes corresponds with an error code. See table below to begin troubleshooting process ***Please count light flashes carefully and multiple times to ensure accuracy- identifying the right error code is the first step in successful troubleshooting of the SKS module.***

of Light

<u>Flashes</u>	<u>Error</u>	<u>Resolution</u>
5	Module out of sync with the key	Check model number of SKS unit.
6	Brake pedal depressed	Make sure that brakes are functioning properly and that there is no pressure on the brake pedal.
7	Hood open	Close hood making sure that both hood latches are closed. Check to make sure hood latch is functioning properly.
8	RPM over normal idle	Check all harnessing and connectors for bent or loose pins and wires. Perform the NG Soft Reset Procedure as described on the previous page. Un-plug the module and plug back in. If error persists, contact Mid City Engineering at 312-421-1114.
9	Push button or key not recognized / present	Insert Keyless Start button in ignition cylinder. Make sure the Keyless Go jumper harness (KG20166) is hooked up properly. Check key box connections.
10	Communication error	Check all harnessing and connectors for bent or loose pins and wires. Perform the NG Soft Reset Procedure as described on the previous page. Un-plug the module and plug back in. If error persists, contact Mid City Engineering at 312-421-1114.

SKSNG166D4 Reference Gallery



w166 T-Harness and KG20166

SKS NG Module

Key Box

EIS mod. kit

Full contents of SKSNG166D4

Mid City Engineering Contact Information

1322 W. Walton St.

Chicago, IL 60642

www.midcityengineering.com

sales@midcityengineering.com

SKSNG166D4 Vehicle coverage

Mercedes

ML 2014-2015

GL 2014-2016

GLE 2016-2019

GLS 2016-2019

G Wagon 2016-2018 (Keyless Start retrofit required for 2016-2017 G Wagon, call Mid City Engineering at 312-421-1114 or sales@midcityengineering.com for more information)

CLA 2015-2019

GLA 2015-2019

Infiniti

Q30 2016-2019

QX30 2016-2019