



REVOLUTION® PET UPRIGHT CARPET CLEANER 3579 SERIES

Important Safety Instructions.....	2
What's in the Box?	2
Assembly	3
Filling the Clean Water Tank.....	3
Cleaning Carpets and Area Rugs.....	4
Cleaning with Hose and Tools.....	5
Emptying the Dirty Water Tank.....	7
After-Cleaning Care.....	7
Replacing the Belts and Brush Rolls.....	8
Troubleshooting.....	8
Warranty.....	8

Product Overview

- | | |
|----------------------------|----------------------|
| 1. Upper Handle | 9. Dirty Water Tank |
| 2. Spray Trigger | 10. Float Stack |
| 3. Cord Clip | 11. Recline Pedal |
| 4. Easy Fill / Formula Cap | 12. Belt Access Door |
| 5. Clean Water Tank | 13. Nozzle |
| 6. Carry Handle | 14. Foot |
| 7. Cleaning Mode Switch | |
| 8. Power Button | |

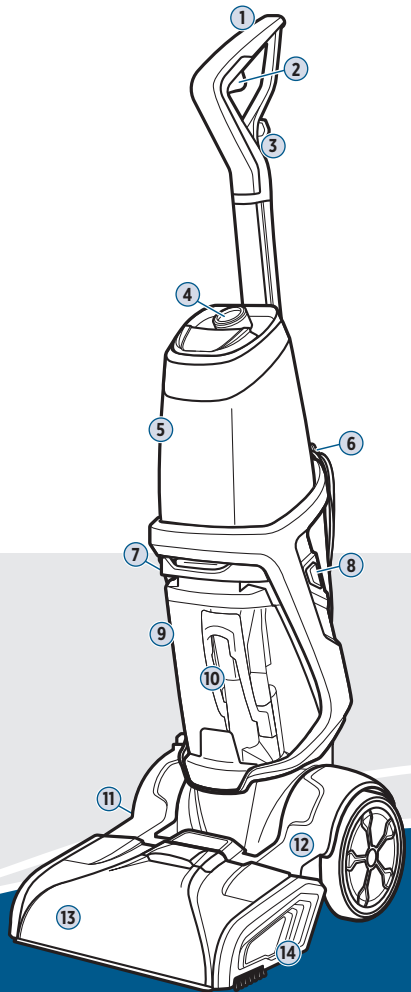

Meet your new BISSELL product!

Go to support.BISSELL.com for a comprehensive walkthrough of your new purchase, including videos, tips, support, and more. Want to get started right away? This guide has all the information you need to set up your new product. Let's take a look...

IMPORTANT SAFETY INSTRUCTIONS



READ ALL INSTRUCTIONS BEFORE USING YOUR APPLIANCE.

When using an electrical appliance, basic precautions should be observed, including the following:



WARNING

TO REDUCE THE RISK OF FIRE, ELECTRIC SHOCK OR INJURY:

- Connect to a properly grounded outlet only. See grounding instructions. Do not modify the three-prong grounded plug.
- Do not leave appliance when it is plugged in. Unplug from outlet when not in use and before servicing.
- Use indoors only.
- Do not allow to be used as a toy. Close attention is necessary when used by or near children.
- Do not use for any purpose other than described in this user guide. Use only manufacturer's recommended attachments.
- Do not use with damaged cord or plug. If appliance is not working as it should, or has been dropped, damaged, left outdoors, or dropped into water, have it repaired at an authorized service center.
- Do not pull or carry by cord, use cord as a handle, close a door on cord, or pull cord around sharp edges or corners.
- Do not run appliance over cord. Keep cord away from heated surfaces.
- Do not unplug by pulling on cord. To unplug, grasp the plug, not the cord.
- Do not handle plug or appliance with wet hands.
- Do not put any object into openings. Do not use with any opening blocked; keep openings free of dust, lint, hair, and anything that may reduce air flow.
- Keep hair, loose clothing, fingers, and all parts of body away from openings and moving parts of the appliance and its accessories.
- Turn OFF all controls before plugging or unplugging appliance.
- Use extra care when cleaning on stairs.
- Do not use to pick up flammable or combustible materials (lighter fluid, gasoline, kerosene, etc.) or use in areas where they may be present.
- Do not use appliance in an enclosed space filled with vapors given off by oil-based paint, paint thinner, some moth-proofing substances, flammable dust, or other explosive or toxic vapors.
- Do not use to pick up toxic material (chlorine bleach, ammonia, drain cleaner, etc.).
- Do not pick up anything that is burning or smoking, such as cigarettes, matches or hot ashes.
- Do not pick up hard or sharp objects such as glass, nails, screws, coins, etc.
- Do not use without filters in place.
- Use only BISSELL® cleaning formulas intended for use with this appliance to prevent internal component damage. See the "Cleaning Formulas" section of this guide.
- Do not immerse. Use only on surfaces moistened by the cleaning process.
- Keep appliance on a level surface.
- Do not carry the appliance while in use.
- Always install float before any wet pick-up operation.
- Unplug before connecting TurboBrush® Tool.
- Plastic film can be dangerous. To avoid danger of suffocation, keep away from children.
- Liquid must not be directed towards equipment containing electrical components.
- Use only the type and amount of liquids specified under the operations section of this guide.

SAVE THESE INSTRUCTIONS

THIS MODEL IS FOR HOUSEHOLD USE ONLY. COMMERCIAL USE OF THIS UNIT VOIDS THE MANUFACTURER'S WARRANTY.

WARNING

Improper connection of the equipment-grounding conductor can result in a risk of electrical shock. Check with a qualified electrician or service person if you aren't sure if the outlet is properly grounded. **DO NOT MODIFY THE PLUG.** If it will not fit the outlet, have a proper outlet installed by a qualified electrician. This appliance is designed for use on a nominal 120-volt circuit and has a grounding attachment plug that looks like the plug in the illustration. Make certain that the appliance is connected to an outlet having the same configuration as the plug. No plug adapter should be used with this appliance.

GROUNDING INSTRUCTIONS

This appliance must be connected to a grounded wiring system. If it should malfunction or break down, grounding provides a safe path of least resistance for electrical current, reducing the risk of electrical shock. The cord for this appliance has an equipment-grounding conductor and a grounding plug. It must only be plugged into an outlet that is properly installed and grounded in accordance with all local codes and ordinances.

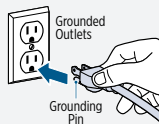

IMPORTANT INFORMATION

If your appliance has a motorized brush roll, do not leave machine running in the same spot without the handle fully upright.

What's in the Box?

Standard accessories may vary by model. To identify what should be included with your purchase, please refer to the "Carton Contents" list located on the carton top flap.

Handle (screw attached)	Base & Dirty Water Tank	Clean Water Tank	Carry Handle	Trial Formula(s)	Accessory Bag & Hose	Tools (vary by model)

Assembly

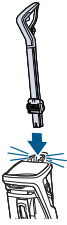

1. Insert handle at the top of the base until it clicks.

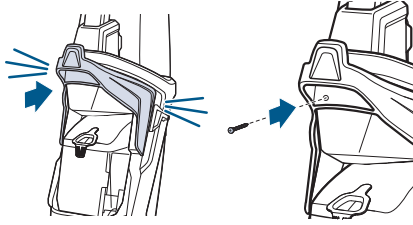

2. Align carry handle with slots on either side of base until it clicks into place. Use a Phillips-head screwdriver to insert screw (taped to handle).

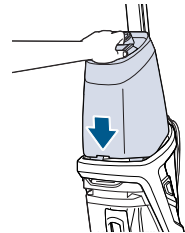

3. Align the clean water tank with grooves and slide into place.

Filling the Clean Water Tank

This machine is compatible with BISSELL® formulas made for upright carpet cleaners. Always use genuine BISSELL formulas in your machine. Other formulas may harm the machine.



1. Choose your formula.* Scan the QR code with your smartphone camera or visit BISSELL.com for formulas.

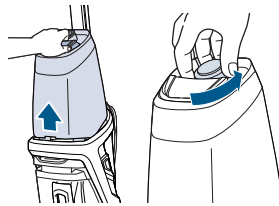

2. Lift the clean water tank up to remove from the machine. Unscrew the cap.

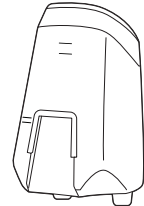

3. Use MAX/DEEP Clean or Express Clean lines for regular formula. Use **easy fill** lines for ANTIBACTERIAL formula.



Regular Formula



easy fill
ANTIBACTERIAL Formula

4. Fill the tank with warm tap water (140°F/60°C MAX) to the WATER line. Do not use boiling water. Do not heat water or tank in microwave. Add formula to FORMULA line.

Optional: Add 2 oz of OXY Boost. OXY Boost is not compatible with **easy fill** ANTIBACTERIAL formula.

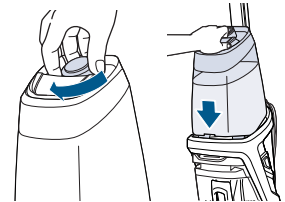

5. Screw the cap back on and slide tank into place.

⚠ WARNING To reduce the risk of fire and electric shock due to internal component damage, use only BISSELL cleaning formula intended for use with this machine.

NOTICE BISSELL ANTIBACTERIAL formula is only for BISSELL machines with Easy Fill System.

Cleaning Carpets and Area Rugs

Visit support.BISSELL.com for helpful how-to carpet cleaning videos.

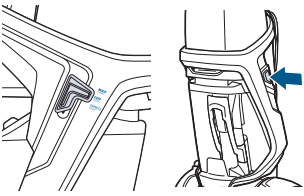
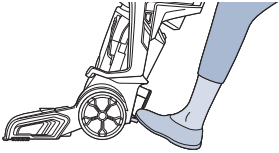
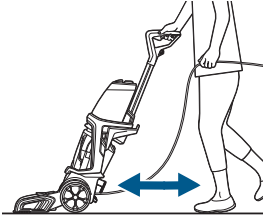

- Remove any solids and use a dry vacuum cleaner before using your deep cleaner.
- To prevent damage to Berber carpets, avoid repeated strokes in the same area. Before cleaning area rugs, check the manufacturer's tag and test an inconspicuous spot for colorfastness. Don't use on silk or delicate rugs.
- Stay off carpet until dry.

		
<p>1. Plug into a properly grounded outlet. Select cleaning mode using the chart below. Press the power button to turn the machine ON.</p>	<p>2. Press the recline pedal with your foot. Hold spray trigger for 10 seconds to wet the brush roll.</p>	<p>3. Make passes based on your selected cleaning mode (see chart below). When finished, turn machine OFF.</p>

Cleaning Modes & Instructions

<p>MAX or DEEP Clean Mode Delivers a deep clean to your carpet.</p> <p>Suggested Pace: 8 inches per second</p> <ol style="list-style-type: none">1. Hold spray trigger<ul style="list-style-type: none">• One pass forward• One pass back2. Release the spray trigger<ul style="list-style-type: none">• One pass forward• One pass back	<p>MAX or DEEP Clean Mode with BISSELL® ANTIBACTERIAL Formula</p> <p>Suggested Pace: 8 inches per second</p> <ol style="list-style-type: none">1. Hold spray trigger<ul style="list-style-type: none">• One pass forward• One pass back• One pass forward2. Release the spray trigger<ul style="list-style-type: none">• One pass back	<p>Express Clean Mode Provides a lighter clean that dries in about 30 minutes.</p> <p>Suggested Pace: 12 inches per second</p> <ol style="list-style-type: none">1. Hold spray trigger<ul style="list-style-type: none">• One pass forward• One pass back2. Release the spray trigger<ul style="list-style-type: none">• One pass forward• One pass back3. With trigger released, make passes until little water comes through the nozzle.
--	--	---

Cleaning with Hose and Tools

Tools vary by model. Visit BISSELL.com to purchase additional tools.

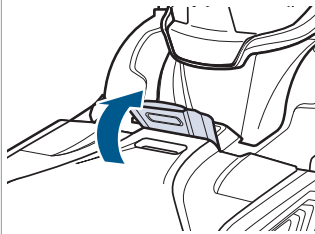

1. Lift the accessory hose door toward the machine to open.

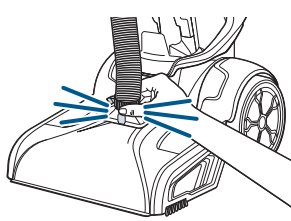

2. Insert the hose and snap into place with colored release clip facing away from machine.

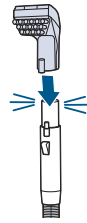

3. Attach the tool to the end of the hose.

Deep Stain Tool; 3", 4" and 6" Tools; and Spraying Crevice Tool

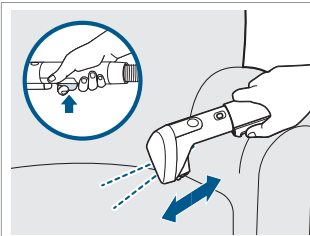

1. Point the tool about 1 inch above the spot or stain and press the spray trigger.

Deep Stain Tool: Set the tool directly on the surface and pull the trigger. Always keep tool in contact with carpet to avoid over-spraying.

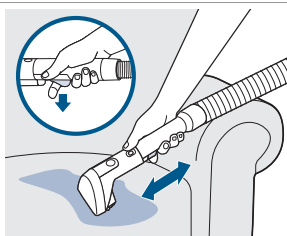

2. Release spray trigger and gently scrub the stain.

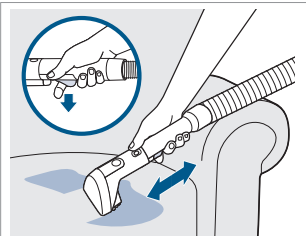

3. Suction the stain by placing tool onto surface and slowly moving backwards.

3-in-1 Stair Tool

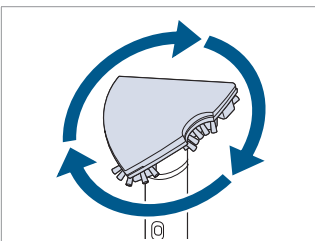

1. Twist tool to desired position. The downward facing edge is the active cleaning mode.

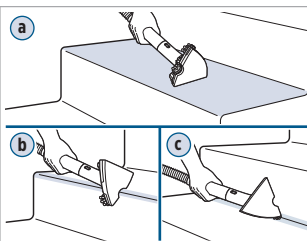

2. Use to clean stairs three ways:
a. Flat edge: stair tread
b. Indented area: outer corner
c. Pointed edge: inner corner

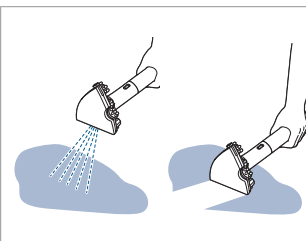

3. Point the tool about 1 inch above the stain and press the spray trigger. Suction the stain by placing tool onto surface and slowly moving backwards.

CONTINUED ON NEXT PAGE ➔

Stain Trapper Tool

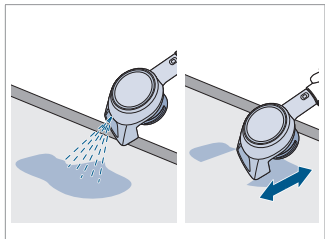
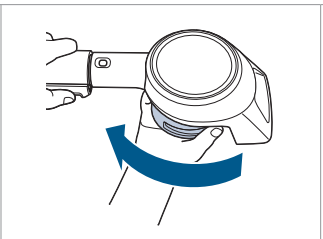
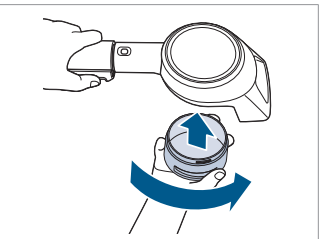
		
<p>1. Point the tool about 1 inch above the spot or stain and press the spray trigger. Suction up the stain by placing tool onto surface and slowly moving backwards.</p>	<p>2. To empty the tool tank, rotate clockwise. Pour dirty liquid into sink or toilet and rinse. Allow time to air dry.</p>	<p>3. Return the tank to the tool by lining up the grooves and twisting it into place.</p>

2-in-1 Upholstery Tool

	 <p>Dry Suction Channel</p>	 <p>Wet Suction Channel</p>
<p>Switch between dry and wet settings and turn machine ON.</p>	<p>Dry Cleaning Vacuum up debris from carpet or upholstery.</p>	<p>Wet Cleaning 1. Hold down trigger to activate spray. 2. Release trigger and suction up the stain.</p>

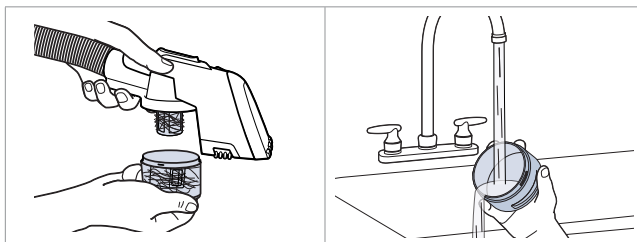

Emptying the Dirt Bin

- 1.** Twist dirt bin to open. Empty debris into a garbage bin.
- 2.** Rinse dirt bin. Let dry completely before reinstalling.

⚠ WARNING To reduce the risk of fire, electric shock or injury, turn power OFF and disconnect plug from electrical outlet before performing maintenance or troubleshooting.

Emptying the Dirty Water Tank

↖ For more helpful maintenance tips, check out support.BISELL.com.

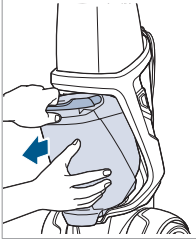

1. Press tank handle and tilt tank toward you. Grab handle and tank with both hands and pull up and away to remove.

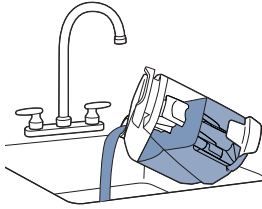

2. Empty the tank. **Quick empty:** Pull the rubber tab and tilt to pour. When closing, ensure tab is sealed tight. **Final clean and rinse:** Unscrew ring at bottom of tank. Remove and rinse float stack. Reinstall float stack by aligning arrows and lock into place. Twist and lock ring to keep water from leaking.

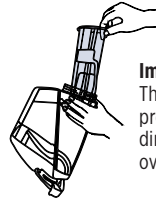

Important:
The float stack prevents your dirty tank from overflowing.



3. Clean the red filter below the tank by wiping off any remaining dirt or debris.

After-Cleaning Care

↖ For more helpful maintenance tips, check out support.BISELL.com.



Rinsing the Machine

1. Rinse out the clean water tank to remove formula. Fill tank with warm tap water. Twist cap back on tightly.
2. Turn machine ON and press trigger for 15 seconds while making back and forth passes on a section of carpet. Release the trigger and extract the water. See above to clean the dirty water tank.

Cleaning the Nozzle

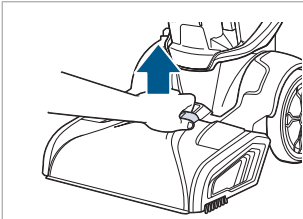

1. Turn machine OFF. Pull the accessory hose door up to remove nozzle.

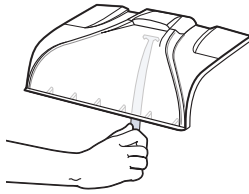

2. Rinse the nozzle. Use the clean out tool to unclog debris.

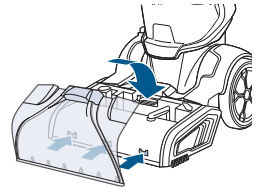

3. Align nozzle from bottom and rotate to snap into place.

Cleaning the Brush Rolls

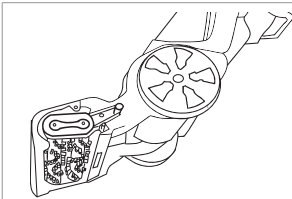

4. Turn machine OFF. Lay machine on it's side or back.

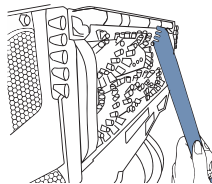

5. Use the comb to brush out debris or hair from brush rolls.

⚠ WARNING To reduce the risk of fire, electric shock or injury, turn power OFF and disconnect plug from electrical outlet before performing maintenance or troubleshooting.

Replacing the Belts and Brush Rolls

▶ Scan the QR code or visit support.BISSELL.com for videos.

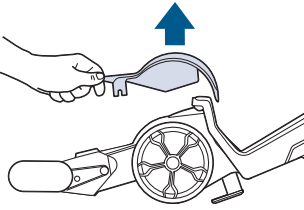

1. Unplug machine and remove both tanks. Remove nozzle and brush roll cover (see steps in "After-Cleaning Care"). Press the recline pedal and lay machine on its back.

2. Use a flathead screwdriver to press into the slot at the back and then front of the belt access door. Lift to remove. Use a Phillips-head screwdriver to remove the screw under the wheel, slide down to remove.

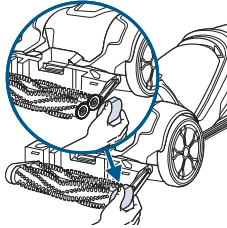

3. Lay machine on its back. Use a Phillips-head screwdriver to remove the screw on the brush roll endcap.

4. If the gear belt is broken or if replacing brush rolls, remove the belt. Be careful the washers at the end of the brush rolls do not fall off or get lost.

5. Align brush rolls with belt at other end. To ensure alignment, hold the end of one brush roll and twist. Check that washers are in place. Reassemble the belt and endcap, securing with screws.

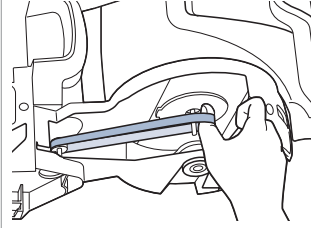

6. If the flat belt is broken, gently remove. If it needs replacing for any reason, remove the gear belt before removing the flat belt. With machine on its side, feed the new belt through the opening and wrap around red pulley.

7. Lay machine on its back. Stretch the flat belt to wrap around the metal axle.

8. Slide the wheel back into the slot and secure with screw.

9. Snap the belt access door back into place.

Troubleshooting

For a comprehensive walkthrough of your product and support tips visit support.BISSELL.com. Any other servicing should be performed by an authorized service representative.



Warranty

Limited 5-year warranty, may vary by state. Visit support.BISSELL.com or call 1-800-237-7691 for complete warranty information.

♥ Every Purchase Saves Pets™

BISSELL proudly supports BISSELL Pet Foundation® and its mission to help save homeless pets. When you buy a BISSELL® product, you help save pets, too. We're proud to design products that help make pet messes, odors and pet homelessness disappear.

Visit BISSELLsavespets.com to learn more.

