

# Important Safety Instructions

## IMPORTANT SAFETY INSTRUCTIONS

ZE

**WARNING:** If the instructions contained in this manual are not followed precisely, fire or explosion may result causing property damage, personal injury or loss of life.

- Do not store or use gasoline or other flammable vapors or liquids near this or any other appliance.

### WHAT TO DO IF YOU SMELL GAS

- Do not try to light any appliance.
- Do not touch any electrical switches.
- Do not use any telephones in your building.
- Immediately call your gas supplier from a neighbor's phone. Follow the gas supplier's instructions.
- If you cannot reach your gas supplier, call the fire department.
- Installation and service must be performed by a qualified installer, service company or gas supplier.



**READ AND SAVE THESE INSTRUCTIONS** - Your safety and the safety of others are very important.

We have provided many important safety messages throughout this manual and on the appliance.

Read all the instructions before using the appliance and always obey all safety messages.



### RECOGNIZE SAFETY INFORMATION

This is a safety alert symbol. This symbol alerts you to potential hazards that can result in severe personal injury or loss of life.

### UNDERSTAND SIGNAL WORDS

A signal word - DANGER, WARNING or CAUTION - is used with the safety alert symbol. DANGER denotes the most serious hazards. It means you could lose your life or be seriously injured if you do not immediately follow the instructions. WARNING means you could lose your life or be seriously injured if the instructions are not followed. CAUTION indicates a potentially hazardous situation which, if not avoided, could result in minor to moderate injury.

# Important Safety Instructions

The safety messages will inform you of potential hazards, on how to avoid the risk of injury and what can occur if the instructions are not followed.

**IMPORTANT: Observe all codes and ordinances in force.**

**WARNING:** For your safety, the instructions contained in this manual must be followed to minimize the risk of fire or explosion and to prevent property damage, personal injury or loss of life.

- This conversion kit must be installed by a qualified service agency in accordance with the manufacturer's instructions and all applicable codes and requirements of the authority having jurisdiction.
- If the information in these instructions is not followed exactly, a fire, an explosion or production of carbon monoxide may result causing property damage, personal injury or loss of life.
- The qualified service agency is responsible for the proper installation of this kit. The Installation is not correct and complete until the operation of the converted appliance is checked as specified in the manufacturer's instructions supplied with the kit.
- For an installation at altitudes above 2000 ft (610 mt) contact the Service Centre.

Installation shall not be considered correct and complete until the operation of the converted appliance is checked as specified in the manufacturer's instructions supplied with this kit.

## WARNING



## FIRE HAZARD

Securely tighten all gas connections. If connected to LP, have a qualified technician ensure that the gas pressure does not exceed a 14" W.C.P. Examples of qualified technicians include licensed heating personnel, authorized gas company personnel and authorized service personnel.

**FAILURE TO DO SO CAN RESULT IN LOSS OF LIFE, EXPLOSION, OR FIRE.**

**Caution:** Before proceeding with the conversion, the gas supply must be shut off prior to disconnecting the electrical power.



## 1 List of components

This conversion kit consists of the following components:

- One label for LPG injectors

## KIT INJECTORS FOR L.P.G. GAS

N°: 691131353 FOR MODEL

Injecteurs kit pour le gaz P.L.

N°: 691131353 pour le modèle

# CPF36UGG

913092708

- One injector  $\varnothing$  0.60 mm for the **Auxiliary** burners.
- One injector  $\varnothing$  0.80 mm for the **Semi-rapid** burner.
- One injector  $\varnothing$  0.88 mm for the **Reduced Rapid** burner.
- One injector  $\varnothing$  0.98 mm for the **Rapid** burner.
- One injector  $\varnothing$  0.54 mm for the **Ultra-rapid Dual** burner (internal crown).
- One injector  $\varnothing$  1.10 mm for the **Ultra-rapid Dual** burner (external crown).
- Two injectors  $\varnothing$  1.20 mm for **Oven and Broiler** burners.

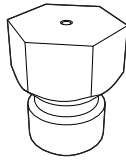

- One warning label change injectors

THIS APPLIANCE WAS CONVERTED ON:  
Cet appareil a été converti le:

\_\_\_\_\_ (DAY, MONTH, YEAR) (jour, mois, année)

TO GAS/au gaz \_\_\_\_\_ WITH KIT N°/avec le kit n°: \_\_\_\_\_

BY/par \_\_\_\_\_

(name and address of organization making this conversion)  
(nom et adresse de l'organisme effectuant cette conversion)

WHICH ACCEPTS THE RESPONSIBILITY THAT THIS  
CONVERSION HAS BEEN PROPERLY MADE

Qui accepte la responsabilité que cette conversion  
a été effectuée de manière adéquate

THIS PRESSURE REGULATOR HAS BEEN  
CONVERTED FOR USE WITH GAS: \_\_\_\_\_

Ce régulateur de pression a été converti pour

l'utilisation avec le gaz: \_\_\_\_\_ Cod. 92849A078

- One seal gasket  
12.5x18.5x2 (mm).

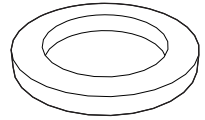



# Conversion Kit

## 2 Gas connection

Check that the main gas supply line to the range is shut off and that the power supply cord is disconnected.

To Range

Shutoff Valve  
"open" position

Gas Supply Line



## 3 Adaptation to different types of gas

To adapt the regulator to the type of gas used, the following must be done:

1. Unscrew the cover of the pressure regulator.
2. Unscrew the spring retainer from the cover.
3. Screw the spring retainer back on according to the type of gas used (see the following illustrations).

- **Natural Gas:** Set pressure to 5" W.C.P. Incoming line pressure of 6" - 10 1/2" W.C.P maximum.

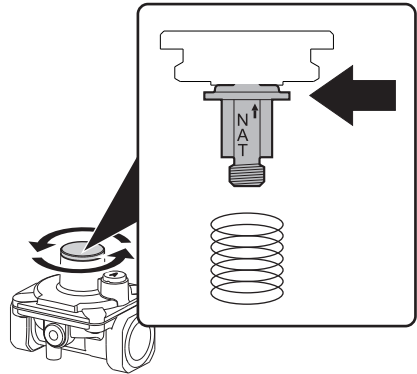

- **LP Gas:** Set pressure to 10" W.C.P. Incoming line pressure 11" - 13" W.C.P. maximum.

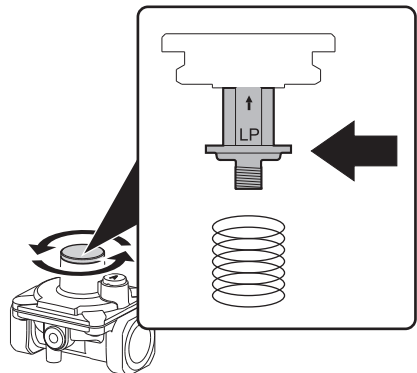



- Incoming line pressure upstream from the regulator must be 1" (2.5 cm) W.C.P. higher than the manifold pressure in order to check the regulator.

The range must be isolated from the gas supply piping system by turning off the respective manual shut-off valve during any pressure testing of the gas supply piping system at test pressures equal to or greater than 1/2 PSIG (3.5 kPa).

## 4 Replacing the rangetop's burners nozzles:

1. Remove all the grates and all the burner caps (1) and heads (2);

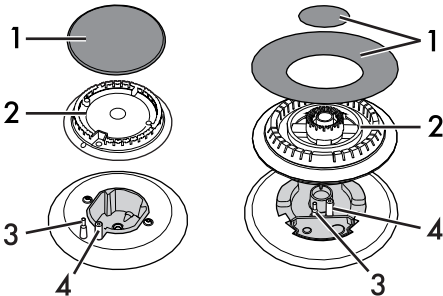

2. Unscrew the burner nozzles with a 7 mm socket wrench;

3. Replace the nozzles according to the type of gas to be used and the description in section 3.2 "Burner and nozzle characteristics table".

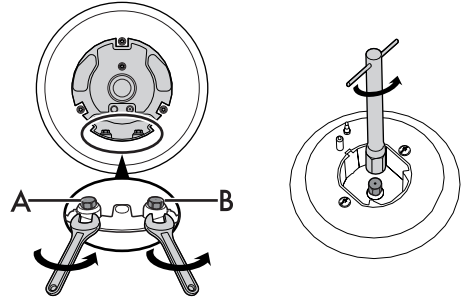

Ultra-rapid Dual burner

(A) Internal crown - (B) External crown

4. Put the burners back in their correct position. Make sure that the holes of the flame-spreader crowns are aligned with the thermocouples (3) and igniters (4).



## Conversion Kit

### 5 Replacing the oven burner nozzle

1. Open the oven door and remove all of the accessories from inside the oven.
2. Remove the shelf.

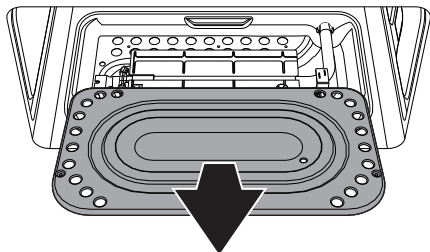

3. Remove the oven burner fastening screws from the base.

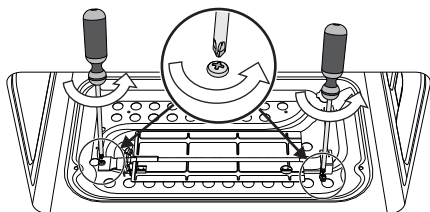

4. Lift the burner at the side and pull it towards you to remove it from its seat.

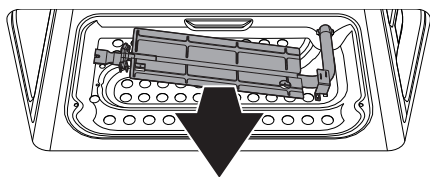

5. Replace the nozzle using a 7 mm socket wrench; install the most suitable one for the type of gas used.

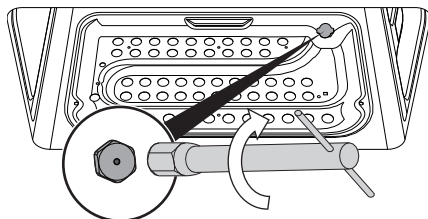
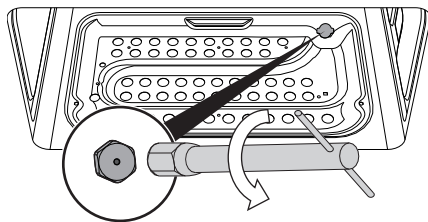

The tightening torque of the nozzle must be 4 Nm.

6. After having replaced the nozzle, put the burner back in its seat.



Take care not to damage the thermocouple or the igniter when doing this.

7. Tighten the burner fastening screws.
8. Replace the shelf in its seat.



Take care not to damage the thermocouple or the igniter when doing this.



## 6 Replacing the gas grill nozzle

1. Open the door and remove all accessories inside the oven.
2. Loosen the screws fastening the gas burner with grill to the upper part of the oven.

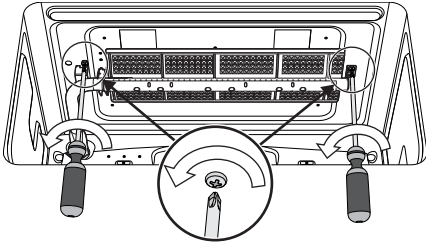

3. Push the burner until the nozzle is accessible.

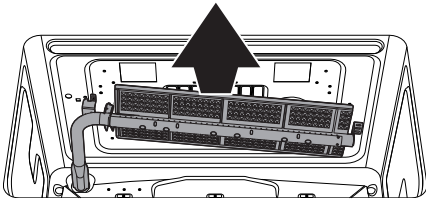

4. Replace the nozzle with the most suitable one for the type of gas used using a 7 mm socket wrench.

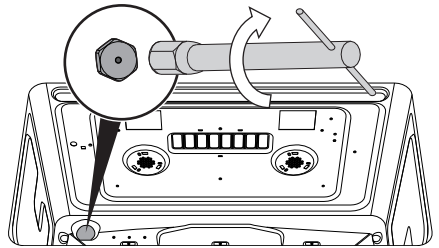
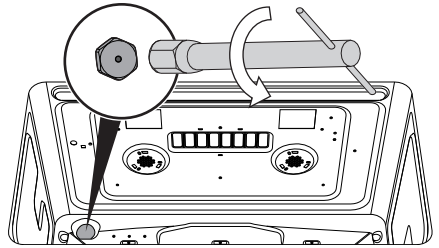

The tightening torque of the nozzle must be 4 Nm.

5. After having replaced the nozzle, put the burner back in its seat.



Take care not to damage the thermocouple or the igniter when doing this.

6. Tighten the burner fastening screws.



## Conversion Kit

### 7 Test the appliance

Follow these instructions to leak test the appliance:

Use a brush and liquid detergent to test all gas connections for leaks. Bubbles around connections indicate a leak. If a leak appears, shut off the gas valve controls and adjust the connections. Then check the connections again. Remove all the detergent product from the range. Replace the parts on the burner and turn the knobs on the gas tap valves.

### **NEVER TEST FOR GAS LEAKS WITH A MATCH OR OTHER FLAMES.**

Check that the flame at the maximum flame position has a blue color. It should be clean and soft in character. No blowing or lifting of flame should occur. Occasional orange flashes are normal and reflect different elements in the air or gas.

Wipe away all the detergent product from the range.

Replace the parts on the burner and turn the knobs on the gas tap valves.

### 8 Minimum adjustment

#### **For natural Gas:**

Light the burner and turn the knob to the minimum position . Remove the gas tap knob and turn the adjustment screw at the side of the tap rod until the desired minimum flame is achieved.

Refit the knob and verify that the burner flame is stable (when turning the knob rapidly from the maximum to the minimum position the flame must not go out).

Repeat this operation on the remaining gas taps on the cooktop.

#### **For LP Gas:**

Turn off the burners and unplug the appliance from the electrical power supply.

For regulating the minimum with LP, the screws at the side of the tap rod must be turned clockwise all the way. Once the regulation has been completed, replace the seal on the by-passes using paint or similar materials. Follow the instructions given in point 9 to locate the adjustment screws.



# Conversion Kit



## 9 Burner and nozzle characteristics tables

To adjust the range for LP gas or to return to Natural Gas use, refer to the charts below.

Natural Gas	AUX	SR	RR	R	DUAL int	DUAL est	Oven	Broiler
QT (BTU)	4500	8000	10500	12000	4000	16000	17000	17000
Injector Ø (mm)	0.90	1.20	1.40	1.52	0.90	1.75	180	180
QR (BTU)	1200	1600	2400	2400	800	4200	-	-
LP	AUX	SR	RR	R	DUAL int	DUAL est	Oven	Broiler
QT (BTU)	4200	7500	9500	11000	3500	14500	17000	17000
Injector Ø (mm)	0.60	0.80	0.88	0.98	0.54	1.10	120	120
QR (BTU)	1200	1600	2400	2400	800	4200	-	-
By-pass (mm)	0.33	0.39	0.45	0.45	0.30	0.63	-	-

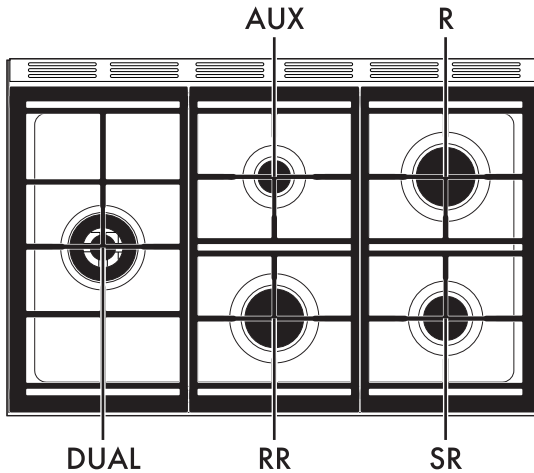

**NOTE:** Save the nozzles that were removed from the appliance along with these instructions for possible future use.

### WARNING



### FIRE HAZARD

Use a soapy solution to check that it is leak-tight.

Never test for gas leaks with a match or other flames.

Failure to follow this instruction can result in loss of life or fire.





# Conversion Kit

## 10 Combustion products

The combustion products may be extracted by means of hoods connected to a natural draught chimney whose efficiency is certain or via forced extraction. An efficient extraction system requires precision planning by a specialist qualified in this area and must comply with the positions and distances indicated by the applicable standards.

When the job is complete, the installer must issue a certificate of conformity.

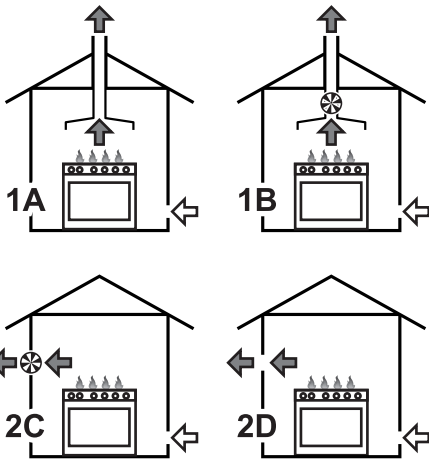
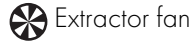

1 Extraction using a hood

2 Extraction without a hood

A Single natural draught chimney

B Single chimney with extractor fan

C Directly outdoors with wall- or window-mounted extractor fan

D Directly outdoors through wall

## 11 Final operations

- Completely fill out the conversion label (part no. 92849A078) and attach it to the rear of the appliance. Do not cover any other labels with the conversion label.
- Over time the gas taps may become difficult to turn and get blocked. Clean them internally and replace the lubrication grease.



Lubrication of the gas taps should be performed by a specialised technician.

- Save the nozzles removed from the unit along with these instructions for possible future use.
- For installation of the appliance at high altitude, please consult your local gas company for their recommendation on the correct orifice sizes and any other necessary adjustments that will provide proper gas combustion at specified altitudes.

## 12 Natural Gas

To convert back to Natural Gas, follow steps 1 through 7 and replace the nozzles in the order in which they were removed.