

# 10.0 ELLIPSE BOLLARD SUBWOOFER

*The 10.0 Ellipse Bollard Subwoofer* contains a 7x10 woofer. Its sleek design that can be easily hidden within a landscape yet looks great when installed out in the open. It has a larger driver area compared to conventional outdoor speakers offering higher performance, higher efficiency, higher fidelity & less compromise. Installation flexibility in many forms for above-ground or in-ground applications. The Bollard features high quality materials and construction built to Defy the Elements™. It is built to be part of a complete patented Coastal Source Plug+Play system or can be easily integrated into existing systems.

U.S. Design Patent D725,552

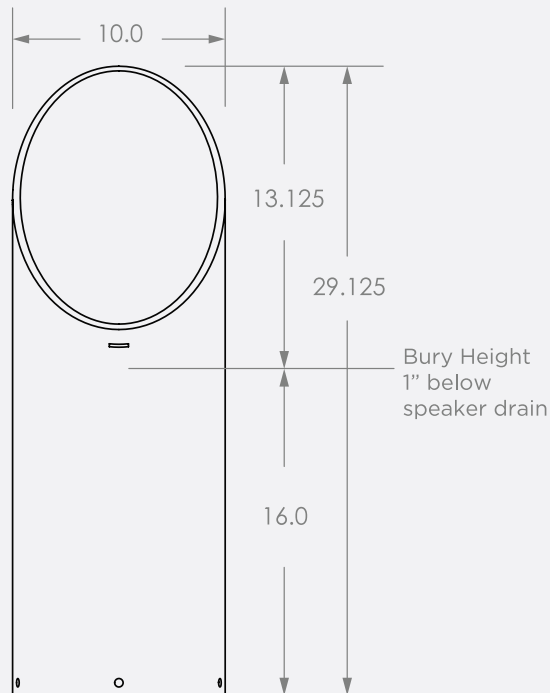

BROWN



## 10.0 ELLIPSE BOLLARD SUBWOOFER SPECIFICATIONS

Size: 29.125in (H) x 10.0in (Ø)

Weight: 17.0 lbs

Construction: Rotomolded color through composite

Finish: Brown

Subwoofer: 7" x 10" Composite w/ Santoprene Surround

Power Handling: 100W Max Power

Minimum Amplifier Response (per speaker): 50 Watts

Frequency Response: 50Hz - 300Hz

Efficiency: 90dB 1w/M

Dispersion: 360°

Impedance: 8 ohms

Mounting: Freestanding, Partial Burial, or Hardscape Mount (optional)

Speaker Connector: CC Male Direct Connector



Warranty: 5-Year Limited Warranty\*

# ORDERING INFORMATION

FIXTURE	FINISH
<b>EB10SW710</b> (10.0 ELLIPSE BOLLARD SUBWOOFER)	<b>BN</b> (BROWN) 
<b>NOTE:</b> Custom colors and designs are available for this product as part of the Designer Series. Contact Coastal Source for details.	

**EB10SW710** — **BN** e.g. **EB10SW710BN** = Brown 10.0 Ellipse Bollard Subwoofer

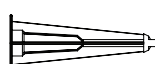
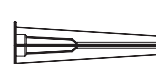
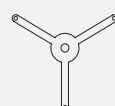
## ACCESSORIES

SKU	ITEM		
BHM10	10.0 Bollard Hardscape Mount		
RTS8xx RTS12xx	Removable Tip Stakes	 8" Stake	 12" Stake
SPTRISTB	Large Tri-Stabilizer		
MMA3/4xx	¾" Male-to-Male Adapter		
THG10BK	Theft Guard		

\*All Coastal Source products bear a 2-year limited warranty for commercial/non-residential installations.