



HUSH SYSTEM



SEAMLESS LOOK



GREASE COLLECTORS



PROFESSIONAL PERFORMANCE



HEAT GUARD

ELICA'S EXCLUSIVE PLUS FEATURES

Scanno available in 28", 34" & 46" sizes and with only 15 5/8" depth make it perfect to discreetly mount it inside any slim cabinet.

While having a powerful performance of 600 and 1200 CFM blower for extraordinary ventilating power. Plus the All-In-One design avoids the need to purchase a stainless liner. Hidden metallic in/out knob controls operate the 4-speed blower and LED Lighting.

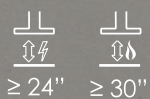
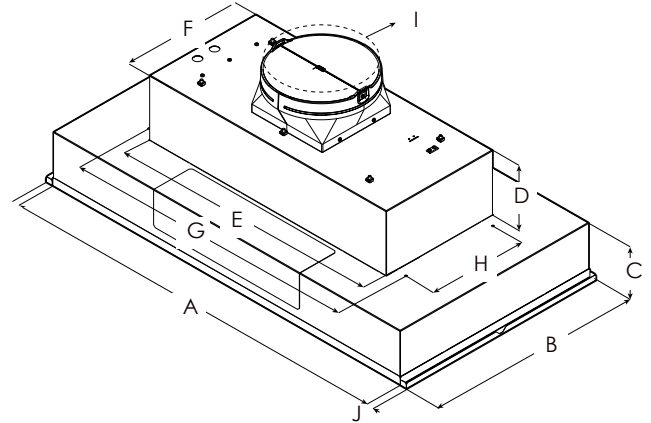





MOUNTING HEIGHT RANGE

	ESC628SS	ESC134SS	ESC146SS
A	28 1/2" / (87.5 cm)	34 1/2" (87.5 cm)	46 1/2" (87.5 cm)
B	15 5/8" (39.8 cm)		
C	5 7/8" (13.8 cm)		
D	6 1/2" (16.4 cm)		
E	22 3/4" (56 cm)	27 7/8" (70 cm)	
F	12 7/16" (31.6 cm)		
G	24 21/64" (62 cm)	29 13/16" (75.7 cm)	
H	10 1/8" (25.7 cm)		
I	10" (25.4 cm)		
J	3/4" (1.9 cm)		

Width:	28" Unit	34" Unit	46" Unit
Model:	ESC628SS	ESC134SS	ESC146SS
Dimensions:	28 1/2"W x 15 5/8 "D x 11 15/16"H	34 1/2"W x 15 5/8 "D x 11 15/16"H	46 1/2"W x 15 5/8 "D x 11 15/16"H
Blower Type (Internal):**	600 CFM (4-speed)	1200 CFM (4-speed)	1200 CFM (4-speed)
Nois (sones):**	7.0 Sones	8.5 Sones	8.5 Sones
Finish:	Stainless Steel		
Controls:	Fully retractable rotating knobs with white backlighting		
Illumination:	2 LED, 7.5 W 3000 Kelvin, 540 lumen		4 LED, 7.5 W 3000 Kelvin, 540 lumen
Grease Filter:	Dishwasher-Safe, Professional Stainless Steel Baffle Filters 2 for 28",34" & 3 for 46"		
Duct Transition:	10" Round with BackDraft Damper (top only)		
Installation Type:	Ducted Installation Only		
Electrical:	120V - 60 Hz, 490 W	120V - 60 Hz, 913 W	120V - 60 Hz, 913 W
KITS:			
1200 CFM External Blower Kit:	KIT0153054		
1200 CFM Inline Blower Kit:	KIT0154387		
10" to 8" transition KIT:	KIT0185271		
Inline Blower Shell Kit:	KIT0179549 (for use with 1200 CFM blowers only)		
External Blower Shell Kit:	KIT0179547 (for use with 1200 CFM blowers only)		
Electronic CFM Reduction Bypass Kit:	KIT0185752 (for 600 CFM Blower),KIT0185099 (for 1200 CFM Blower)		
WARRANTY:***	Two (2) Years Parts & In-Home Labor. Earn an additional One (1) Year of Parts & In-Home Labor by registering on elica.com.		

PLUS FEATURES

- 
HUSH SYSTEM - An exclusive sound deadening technology that effectively reduces sound levels by over 35%
- 
STAINLESS STEEL BAFFLE FILTERS WITH GREASE COLLECTORS - Designed for high airflow cooking, the "S" shape design traps high volumes of grease
- 
SEAMLESS CRAFTSMANSHIP - Heavy gauge stainless steel "Seamless" construction that delivers refined elegance.
- 
PROFESSIONAL PERFORMANCE - Special features and high performances for models with aspiration capacity between 600 and 1200 CFM's
- 
HEAT GUARD - Senses extreme temperatures (>158 F°) and automatically adjusts the blower speed to HIGH



Model	Certified Ratings	High Speed	Working Speed	Duct Size
ESC146SS	CFM	860	320	10" (Vertical)
ESC134SS	Sones	12.5	2	10" (Vertical)
ESC628SS	CFM	500	180	10" (Vertical)
	Sones	9.5	2	10" (Vertical)

* The product images shown are for illustration purposes only and may not be an exact representation of the product.

** Blower performance indicates the performance of the blower by itself. Performance claims are not AHAM certified but were established in accordance with HVI Standardized test procedure. For Certified Ratings, please refer to AHAM Certified Product Directory. Electric Ratings are declared according to UL.

*** For valid warranty extension, register within 3 months from purchase. For USA & Canada Users Only.