









ITEM: 5961-90002-02 Six-Drawer Dresser
 5961-90002-89 Six-Drawer Dresser
 5961-90007-02 Round Mirror
 5961-90007-89 Round Mirror

Thank you for purchasing this quality product. Be sure to unpack carefully looking for small parts which may have come loose during shipment.
 Read all instruction and study the drawing carefully before starting the assembly process.

HARDWARE PACK

PART LIST

NO.	DRAWING	DESCRIPTION	SIZE	Q'TY
A		Flat Washer	1/4"	4PCS
B		Lock Washer	1/4"	4PCS
C		Bolt	1/4"	4PCS
D		Allen Wrench	69mm	1PC
E		Hook	4*53mm	2PCS
F		Plastic Anchor	∅ 9*30mm	2PCS
G		Anti - Tip Kit		1PC

NO.	DRAWING	DESCRIPTION	Q'TY
①		Mirror Support	1PC

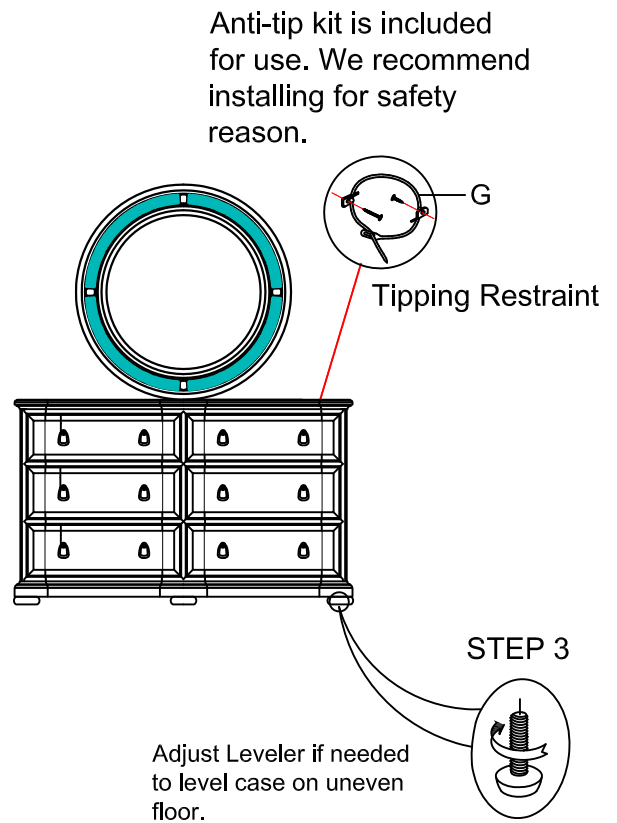
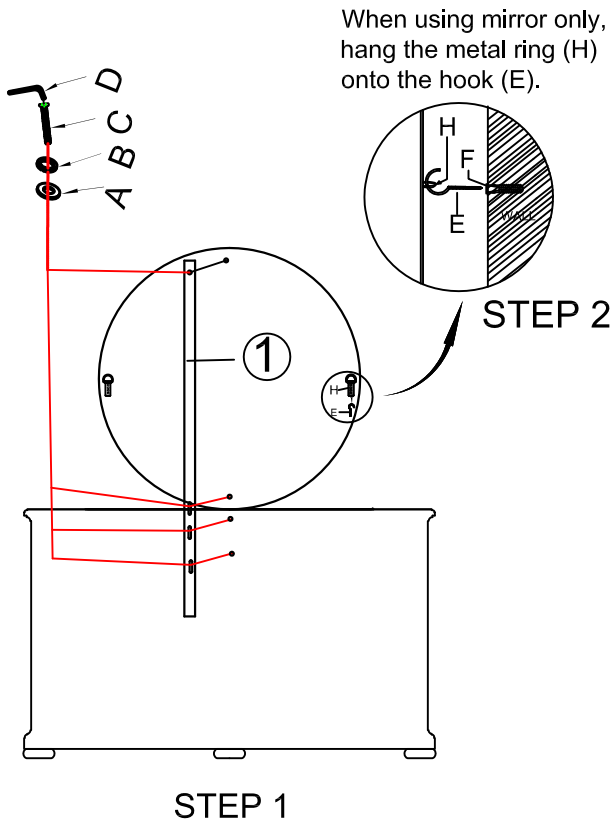

Note: Anti-tip kit restraint is provided. Please follow the instructions enclosed with the pack.