

# AMANA®

---

## STANDARD CLEANING GAS RANGE

### Use & Care Guide

For questions about features, operation/performance, parts, accessories or service, call: **1-866-616-2664** or visit our website at **[www.amana.com](http://www.amana.com)**.

In Canada, call for assistance, installation or service, call: **1-800-807-6777** or visit our website at **[www.amanacanada.ca](http://www.amanacanada.ca)**.

---

---

# TABLE OF CONTENTS

<b>RANGE SAFETY</b> .....	<b>3</b>	<b>OVEN USE</b> .....	<b>8</b>
The Anti-Tip Bracket .....	4	Aluminum Foil .....	8
<b>COOKTOP USE</b> .....	<b>5</b>	Positioning Racks and Bakeware .....	9
Cooktop Controls .....	5	Bakeware .....	9
Surface Burners .....	5	Oven Vent .....	9
Home Canning .....	6	Baking and Roasting .....	10
Cookware .....	6	Broiling .....	10
<b>ELECTRONIC OVEN CONTROL</b> .....	<b>7</b>	<b>RANGE CARE</b> .....	<b>11</b>
Display .....	7	General Cleaning .....	11
Oven Indicator Lights .....	7	Oven Light .....	11
Start .....	7	Oven Door .....	12
Cancel .....	7	Removing the Oven Bottom .....	12
Off/Cancel .....	7	<b>TROUBLESHOOTING</b> .....	<b>13</b>
Tones .....	7	<b>ASSISTANCE OR SERVICE</b> .....	<b>15</b>
Fahrenheit and Celsius .....	7	In the U.S.A. ....	15
Timer .....	7	In Canada .....	15
Warm .....	8	Accessories .....	15
Control Lock .....	8		
Oven Temperature Control .....	8		

# RANGE SAFETY

## Your safety and the safety of others are very important.

We have provided many important safety messages in this manual and on your appliance. Always read and obey all safety messages.



This is the safety alert symbol.

This symbol alerts you to potential hazards that can kill or hurt you and others.

All safety messages will follow the safety alert symbol and either the word "DANGER" or "WARNING."

These words mean:

**⚠ DANGER**

You can be killed or seriously injured if you don't immediately follow instructions.

**⚠ WARNING**

You can be killed or seriously injured if you don't follow instructions.

All safety messages will tell you what the potential hazard is, tell you how to reduce the chance of injury, and tell you what can happen if the instructions are not followed.

**WARNING: If the information in these instructions is not followed exactly, a fire or explosion may result causing property damage, personal injury or death.**

.. Do not store or use gasoline or other flammable vapors and liquids in the vicinity of this or any other appliance.

..WHAT TO DO IF YOU SMELL GAS:

- Do not try to light any appliance.
- Do not touch any electrical switch.
- Do not use any phone in your building.
- Immediately call your gas supplier from a neighbor's phone. Follow the gas supplier's instructions.
- If you cannot reach your gas supplier, call the fire department.

.. Installation and service must be performed by a qualified installer, service agency or the gas supplier.

**⚠ WARNING:**

**Never Operate the Top Surface Cooking Section of this Appliance Unattended**

- Failure to follow this warning statement could result in fire, explosion, or burn hazard that could cause property damage, personal injury, or death.
- If a fire should occur, keep away from the appliance and immediately call your fire department.

**DO NOT ATTEMPT TO EXTINGUISH AN OIL/GREASE FIRE WITH WATER.**

L 6GC>C< /Gas leaks cannot always be detected by smell.

Gas suppliers recommend that you use a gas detector approved by UL or CSA.

For more information, contact your gas supplier.

If a gas leak is detected, follow the "What to do if you smell gas" instructions.

## The Anti-Tip Bracket

The range will not tip during normal use. However, the range can tip if you apply too much force or weight to the open door without the anti-tip bracket fastened down properly.



### **⚠ WARNING**

#### Tip Over Hazard

**A child or adult can tip the range and be killed.**

**Verify the anti-tip bracket has been properly installed and engaged per installation instructions.**

**Re-engage anti-tip bracket if range is moved.**

**Do not operate range without anti-tip bracket installed and engaged.**

**Failure to follow these instructions can result in death or serious burns to children and adults.**

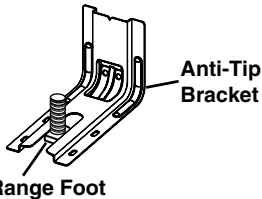

**To verify the anti-tip bracket is installed and engaged:**

- Slide range forward.
- Look for the anti-tip bracket securely attached to floor or wall.
- Slide range back so rear range foot is under anti-tip bracket.
- See installation instructions for details.

## IMPORTANT SAFETY INSTRUCTIONS

**WARNING:** To reduce the risk of fire, electrical shock, injury to persons, or damage when using the range, follow basic precautions, including the following:

- **WARNING:** TO REDUCE THE RISK OF TIPPING OF THE RANGE, THE RANGE MUST BE SECURED BY PROPERLY INSTALLED ANTI-TIP DEVICES. TO CHECK IF THE DEVICES ARE INSTALLED PROPERLY, SLIDE RANGE FORWARD, LOOK FOR ANTI-TIP BRACKET SECURELY ATTACHED TO FLOOR OR WALL, AND SLIDE RANGE BACK SO REAR RANGE FOOT IS UNDER ANTI-TIP BRACKET.
- **WARNING:** NEVER use this appliance as a space heater to heat or warm the room. Doing so may result in carbon monoxide poisoning and overheating of the oven.
- **WARNING:** NEVER cover any slots, holes or passages in the oven bottom or cover an entire rack with materials such as aluminum foil. Doing so blocks air flow through the oven and may cause carbon monoxide poisoning. Aluminum foil linings may also trap heat, causing a fire hazard.
- **CAUTION:** Do not store items of interest to children in cabinets above a range or on the backguard of a range – children climbing on the range to reach items could be seriously injured.

- Proper Installation – The range, when installed, must be electrically grounded in accordance with local codes or, in the absence of local codes, with the *National Electrical Code, ANSI/NFPA 70*. Be sure the range is properly installed and grounded by a qualified technician.
- This range is equipped with a three-prong grounding plug for your protection against shock hazard and should be plugged directly into a properly grounded receptacle. Do not cut or remove the grounding prong from this plug.
- Disconnect power before servicing.
- Injuries may result from the misuse of appliance doors or drawers such as stepping, leaning, or sitting on the doors or drawers.
- Maintenance – Keep range area clear and free from combustible materials, gasoline, and other flammable vapors and liquids.
- Storage in or on the Range – Flammable materials should not be stored in an oven or near surface units.
- Top burner flame size should be adjusted so it does not extend beyond the edge of the cooking utensil.

#### **For self-cleaning ranges –**

- Before Self-Cleaning the Oven – Remove broiler pan and other utensils. Wipe off all excessive spillage before initiating the cleaning cycle.

## SAVE THESE INSTRUCTIONS

# COOKTOP USE

## Cooktop Controls

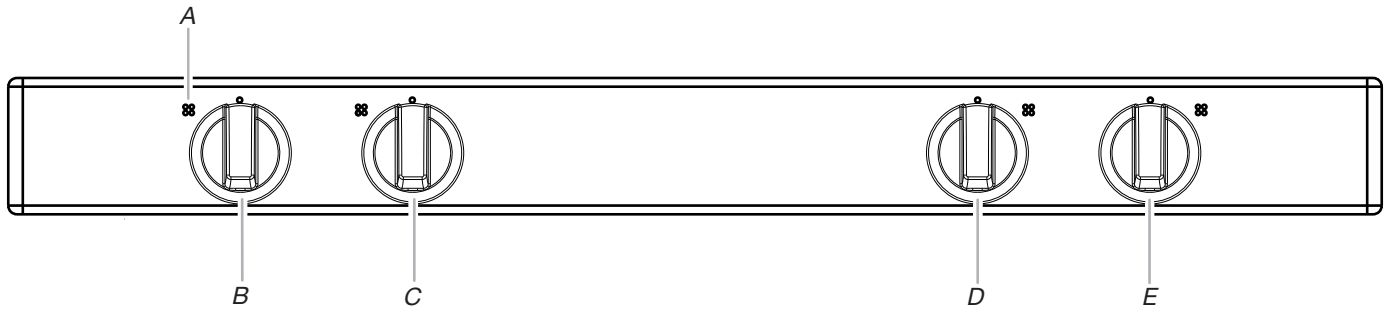

A. Surface burner locator  
B. Left rear burner control knob

C. Left front burner control knob  
D. Right front burner control knob  
E. Right rear burner control knob

**⚠ WARNING**



**Fire Hazard**

**Do not let the burner flame extend beyond the edge of the pan.**

**Turn off all controls when not cooking.**

**Failure to follow these instructions can result in death or fire.**

- All surface burners will click. Only the burner with the control knob turned to LITE will produce a flame.
- Turn knob to anywhere between HI and LO. The clicking will stop. Use the following chart as a guide when setting heat levels.

SETTING	RECOMMENDED USE
LITE	<ul style="list-style-type: none"> <li>Light the burner.</li> </ul>
HI	<ul style="list-style-type: none"> <li>Start food cooking.</li> <li>Bring liquid to a boil.</li> </ul>
MED (medium)	<ul style="list-style-type: none"> <li>Hold a rapid boil.</li> <li>Quickly brown or sear food.</li> <li>Fry or saute foods.</li> <li>Cook soups, sauces and gravies.</li> <li>Stew or steam foods.</li> </ul>
LO	<ul style="list-style-type: none"> <li>Keep food warm.</li> <li>Simmer</li> </ul>

Electric igniters automatically light the surface burners when control knobs are turned to LITE.

Before setting a control knob, place filled cookware on the grate. Do not operate a burner using empty cookware or without cookware on the grate.

**IMPORTANT:** Do not lift the cooktop on sealed burner models. Lifting the cooktop can lead to damage and improper operation of the range.

### To Set Burner Temperature:

- Push in and turn knob counterclockwise to LITE.

### Power failure

In case of prolonged power failure, the surface burners can be lit manually. Hold a lit match near a burner and turn knob counterclockwise to LITE. After burner lights, turn knob to setting.

## Surface Burners

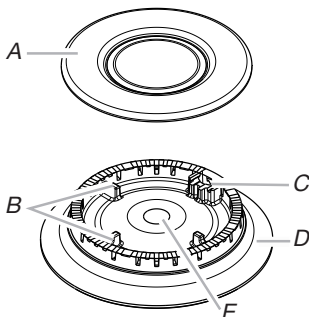

A. Burner cap  
B. Alignment pins  
C. Igniter  
D. Burner base  
E. Gas tube opening

**IMPORTANT:** Do not obstruct the flow of combustion and ventilation air around the burner grate edges.

**Burner cap:** Always keep the burner cap in place when using a surface burner. A clean burner cap will help avoid poor ignition and uneven flames. Always clean the burner cap after a spillover and routinely remove and clean the caps according to the "General Cleaning" section.

**Gas tube opening:** Gas must flow freely throughout the gas tube opening for the burner to light properly. Keep this area free of soil and do not allow spills, food, cleaning agents or any other material to enter the gas tube opening. Keep spillovers out of the gas tube by always using a burner cap.

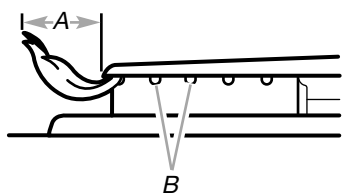

A. 1-1½" (2.5-3.8 cm)  
B. Burner ports

**Burner ports:** Check burner flames occasionally for proper size and shape as shown above. A good flame is blue in color, not yellow. Keep this area free of soil and do not allow spills, food, cleaning agents or any other material to enter the burner ports.

**To Clean:**

**IMPORTANT:** Before cleaning, make sure all controls are off and the oven and cooktop are cool. Do not use oven cleaners, bleach or rust removers.

1. Remove the surface grates.
2. Remove the burner cap from the burner base and clean according to "General Cleaning" section.
3. Clean the gas tube opening with a damp cloth.
4. Clean clogged burner ports with a straight pin as shown. Do not enlarge or distort the port. Do not use a wooden toothpick. If the burner needs to be adjusted, contact a trained repair specialist.

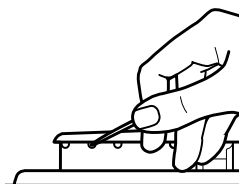

5. Replace the burner cap, making sure the alignment pins are properly aligned with the burner cap.

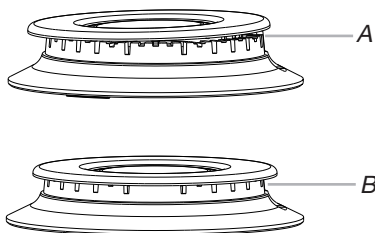

A. Incorrect  
B. Correct

6. Replace the surface grates.
7. Turn on the burner. If the burner does not light, check cap alignment. If the burner still does not light, do not service the burner yourself. Contact a trained repair specialist.

## Home Canning

When canning for long periods, alternate the use of surface burners between batches. This allows time for the most recently used areas to cool.

- Center the canner on the grate above the burner.
- Do not place canner on 2 surface burners at the same time.
- For more information, contact your local agricultural department. Companies that manufacture home canning products can also offer assistance.

## Cookware

**IMPORTANT:** Do not leave empty cookware on a hot surface cooking area, element or surface burner.

Ideal cookware should have a flat bottom, straight sides and a well-fitting lid, and the material should be of medium-to-heavy thickness.

Rough finishes may scratch the cooktop or grates. Aluminum and copper may be used as a core or base in cookware. However, when used as a base they can leave permanent marks on the cooktop or grates.

Cookware material is a factor in how quickly and evenly heat is transferred, which affects cooking results. A nonstick finish has the same characteristics as its base material. For example, aluminum cookware with a nonstick finish will take on the properties of aluminum.

Cookware with nonstick surfaces should not be used under the broiler.

Use the following chart as a guide for cookware material characteristics.

COOKWARE	CHARACTERISTICS
<b>Aluminum</b>	<ul style="list-style-type: none"> <li>■ Heats quickly and evenly.</li> <li>■ Suitable for all types of cooking.</li> <li>■ Medium or heavy thickness is best for most cooking tasks.</li> </ul>
<b>Cast iron</b>	<ul style="list-style-type: none"> <li>■ Heats slowly and evenly.</li> <li>■ Good for browning and frying.</li> <li>■ Maintains heat for slow cooking.</li> </ul>
<b>Ceramic or Ceramic glass</b>	<ul style="list-style-type: none"> <li>■ Follow manufacturer's instructions.</li> <li>■ Heats slowly, but unevenly.</li> <li>■ Ideal results on low to medium heat settings.</li> </ul>
<b>Copper</b>	<ul style="list-style-type: none"> <li>■ Heats very quickly and evenly.</li> </ul>
<b>Earthenware</b>	<ul style="list-style-type: none"> <li>■ Follow manufacturer's instructions.</li> <li>■ Use on low heat settings.</li> </ul>
<b>Porcelain enamel-on-steel or cast iron</b>	<ul style="list-style-type: none"> <li>■ See stainless steel or cast iron.</li> </ul>
<b>Stainless steel</b>	<ul style="list-style-type: none"> <li>■ Heats quickly, but unevenly.</li> <li>■ A core or base of aluminum or copper on stainless steel provides even heating.</li> </ul>

# ELECTRONIC OVEN CONTROL

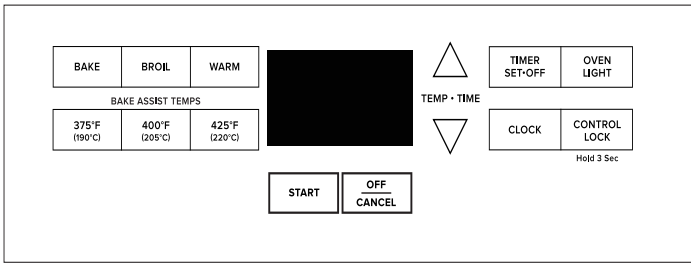

## Display

When power is first supplied to the appliance, a flashing time will appear on the display. Press OFF/CANCEL to clear flashing time from the display.

If flashing time appears, a power failure has occurred. Press OFF/CANCEL and reset the clock if needed.

When the oven is not in use, the display shows the time of day. When performing a cook or timer function, the display will show either hours and minutes, or minutes and seconds.

## Oven Indicator Lights

The indicator lights are located on both sides of the display. The indicator lights light up or flash when the oven is in one of the following modes: Bake, Broil or Timer.

## Start

START begins any oven function. If START is not pressed within 5 seconds after pressing a function pad, the Push to Start (“PSH”) indicator light will flash and the push to start tone will sound as a reminder.

If START is not pressed within 1 minute after pressing a function pad, the oven display will return to the time of day mode and the programmed function will be canceled.

## Off/Cancel

OFF/CANCEL stops any function except the Clock, Timer, and Control Lock.

## Clock

This is a 12 hour clock and does not show a.m. or p.m.

### 12HZi/

Before setting, make sure the oven and Timer are off. Press OFF/CANCEL to cancel the oven, and press TIMER SET/OFF twice to cancel the timer.

1. Press CLOCK.
2. Press the TEMP/TIME “up” or “down” arrow pads to set the time of day.
3. Press CLOCK or START.

## Tones

Tones are audible signals, indicating the following:

### One tone

- Valid pad press
- Oven is preheated (long tone)
- Function has been entered

### Three tones

- Invalid pad press
- Push to start reminder

### Cycling tones

- End of cycle

## Fahrenheit and Celsius

The temperature is preset at Fahrenheit, but can be changed to Celsius.

**To Change:** Press and hold BROIL for 5 seconds. A tone will sound, and “C” will appear on the display. Repeat to change back to Fahrenheit. To exit mode, press OFF/CANCEL or wait 3 seconds.

## Timer

The timer can be set in hours or minutes up to 12 hours and 59 minutes, and counts down the set time either in hours and minutes, or in minutes and seconds. The timer does not start or stop the oven.

### To Set:

1. Press TIMER SET/OFF. The timer indicator light will light up.
2. Press the TEMP/TIME “up” or “down” arrow pads to set the length of time.
3. Press START. When the set time ends, end-of-cycle tones will sound.
4. Press TIMER SET/OFF pad twice anytime to cancel the timer and reminder tones.

If Off/Cancel is pressed, the oven will turn off and the cook function will be disabled.

To display the time of day for 5 seconds when the timer is counting down, press CLOCK.

If Start is not pressed within 5 seconds after pressing Timer Set/Off or Temp/Time arrow pads, the “PSH” indicator light will flash and the push to start tone will sound as a reminder. If no action is taken after 1 minute, the display will return to the time of day or bake or broil mode.

The timer can be reprogrammed to change the time while it is running.

### To Reprogram:

1. Press TIMER SET/OFF.
2. Press the TEMP/TIME “up” or “down” arrow pads to adjust time.
3. Press START.

---

## Warm

### **WARNING**

#### Food Poisoning Hazard

**Do not let food sit in oven more than one hour before or after cooking.**

**Doing so can result in food poisoning or sickness.**

**IMPORTANT:** Food must be at serving temperature before placing it in the warmed oven. Food may be held up to 1 hour; however, breads and casseroles may become too dry if left in the oven during the Warm function. For best results, cover food.

The Warm feature allows hot cooked foods to stay at serving temperature.

#### To Use:

1. Press WARM.
2. Press the TEMP/TIME “up” or “down” arrow keypad until desired temperature is reached. A tone will sound if the minimum or maximum temperature is reached.
3. Press START.
4. Place food in the oven.
5. Press OFF/CANCEL when finished.

**NOTE:** The temperature may be changed at any time by pressing the TEMP/TIME “up” or “down” arrow keypad to reach the desired temperature and then pressing START.

---

## Control Lock

The Control Lock function blocks the control panel pads to avoid unintended use of cook functions.

When the control is locked, only Clock, Oven Light and Timer Set/Off will function.

**To Lock/Unlock Control:** Before locking, make sure the cook functions are off. Press and hold START for 3 seconds, and “Loc” will appear on the display. Repeat to unlock. “Loc” will disappear from the display.

---

## Oven Temperature Control

**IMPORTANT:** Do not use a thermometer to measure oven temperature. Elements will cycle on and off as needed to provide consistent temperature but may run slightly hot or cool at any point in time due to this cycling. Most thermometers are slow to react to temperature change and will not provide an accurate reading due to this cycling.

The oven provides accurate temperatures; however, it may cook faster or slower than your previous oven, so the temperature can be adjusted to personalize it for your cooking needs. It can be changed in Fahrenheit or Celsius.

#### To Adjust Oven Temperature:

1. Press and hold the TEMP/TIME down arrow keypad for 5 seconds until the oven display shows the current setting, for example “0°F CAL” or “00.”
2. Press the TEMP/TIME up or down arrow keypad to increase or to decrease the temperature in 5°F (3°C) amounts. The adjustment can be set between 30°F (18°C) and -30°F (-18°C).
3. Press the START keypad.

---

# OVEN USE

Odors and smoke are normal when the oven is used the first few times, or when it is heavily soiled.

**IMPORTANT:** The health of some birds is extremely sensitive to the fumes given off. Exposure to the fumes may result in death to certain birds. Always move birds to another closed and well-ventilated room.

---

## Aluminium Foil

**IMPORTANT:** To avoid permanent damage to the oven bottom finish and the broiler door handle, do not line the oven bottom with any type of foil or liner.

- On those models with bottom vents, do not block or cover the oven bottom vents.

- For best cooking results, do not cover entire rack with foil because air must be able to move freely.
- To catch spills, place foil on rack below dish. Make sure foil is at least 1/2" (1.3 cm) larger than the dish and that it is turned up at the edges.



## Positioning Racks and Bakeware

**IMPORTANT:** To avoid permanent damage to the porcelain finish, do not place food or bakeware directly on the oven door or bottom.

### RACKS

- Position racks before turning on the oven.
- Do not move racks with bakeware on them.
- Make sure racks are level.

For best performance, cook on one rack. Place the rack so the top of food will be centered in the oven. To move a rack, pull it out to the stop position, raise the front edge, then lift out.

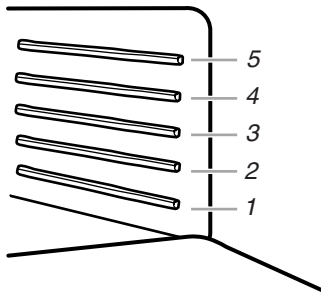

FOOD	RACK POSITION
Cookies, layer cakes, biscuits	2-4
Quick bread, angel food, bundt cakes, pies, pizza	3
Muffins, cupcakes, brownies	4
Large roasts or poultry	2
Casseroles	3

### BAKEWARE

To cook food evenly, hot air must be able to circulate. Allow 2" (5 cm) of space around bakeware and oven walls. Use the following chart as a guide.

NUMBER OF PAN(S)	POSITION ON RACK
1	Center of rack.
2	Side by side or slightly staggered.
3 or 4	Use racks 2 and 4. Position bakeware on racks as shown.

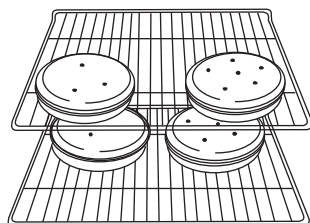

## Bakeware

The bakeware material affects cooking results. Follow manufacturer's recommendations and use the bakeware size recommended in the recipe. Use the following chart as a guide.

BAKEWARE/ RESULTS	RECOMMENDATIONS
<b>Light colored aluminum</b> <ul style="list-style-type: none"> <li>■ Light golden crusts</li> <li>■ Even browning</li> </ul>	<ul style="list-style-type: none"> <li>■ Use temperature and time recommended in recipe.</li> </ul>
<b>Dark aluminum and other bakeware with dark, dull and/or nonstick finish</b> <ul style="list-style-type: none"> <li>■ Brown, crisp crusts</li> </ul>	<ul style="list-style-type: none"> <li>■ May need to reduce baking temperatures slightly.</li> <li>■ Use suggested baking time.</li> <li>■ For pies, breads and casseroles, use temperature recommended in recipe.</li> <li>■ Place rack in center of oven.</li> </ul>
<b>Insulated cookie sheets or baking pans</b> <ul style="list-style-type: none"> <li>■ Little or no bottom browning</li> </ul>	<ul style="list-style-type: none"> <li>■ Place in the bottom third of oven.</li> <li>■ May need to increase baking time.</li> </ul>
<b>Stainless steel</b> <ul style="list-style-type: none"> <li>■ Light, golden crusts</li> <li>■ Uneven browning</li> </ul>	<ul style="list-style-type: none"> <li>■ May need to increase baking time.</li> </ul>
<b>Stoneware/ Baking stone</b> <ul style="list-style-type: none"> <li>■ Crisp crusts</li> </ul>	<ul style="list-style-type: none"> <li>■ Follow manufacturer's instructions.</li> </ul>
<b>Ovenproof glassware, ceramic glass or ceramic</b> <ul style="list-style-type: none"> <li>■ Brown, crisp crusts</li> </ul>	<ul style="list-style-type: none"> <li>■ May need to reduce baking temperatures slightly.</li> </ul>

## Oven Vent

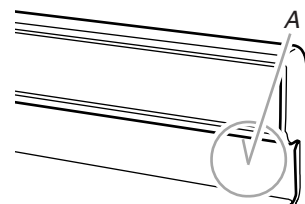

A. Oven vent

The oven vent releases hot air and moisture from the oven, and should not be blocked or covered. Blocking or covering the oven vent will cause poor air circulation, affecting cooking and cleaning results. Do not set plastics, paper or other items that could melt or burn near the oven vent.

---

## Baking and Roasting

**IMPORTANT:** To avoid damage to the interior finish, do not place food or cookware on the oven door or oven bottom.

Before baking and roasting, position racks according to the “Positioning Racks and Bakeware” section.

### To Bake or Roast/

1. Press **BAKE**.  
Press **TEMP/TIME** or **TEMP/HOUR** “up” or “down” arrow pads to set a temperature other than 350°F (175°C) in 5° amounts. The bake range can be set between 170°F and 500°F (75°C and 260°C).
2. Press **START** or **START/ENTER**.  
The temperature can be changed at any time after this step by pressing the **TEMP/TIME** or **TEMP/HOUR** “up” or “down” arrow pads. **START** does not need to be pressed again. If baking/roasting while the Timer is counting down, the set baking/roasting temperature can be displayed for 5 seconds by pressing **BAK**.
3. Press **OFF/CANCEL** or **CANCEL/OFF** when finished.

### Preheating

After **Start** is pressed, the oven will enter a timed preheat cycle. The bake indicator light will light up. The Electronic Oven Control automatically selects the preheat cycle time based on the oven temperature selected. The cycle time will not change if the temperature is reset before the cycle countdown ends. Preheat is complete and the oven is ready to use when a 1 second tone sounds, the cycle countdown ends, and the set temperature is displayed.

Preheat temperatures are affected by varying factors such as room temperature and peak energy usage times. It is normal for the temperature showing on the display and the actual oven temperature to differ.

Waiting an additional 10 minutes after the preheat time ends to put food in the oven is suggested when baking foods with leavening ingredients, such as yeast, baking powder, baking soda and eggs.

**IMPORTANT:** When the oven is baking, the burner in the broiler drawer will be on. Do not store anything in the broiler drawer.

---

## Broiling

### BROILER

The broiler is located below the oven door. Use an oven rack for broiling. To remove a rack, pull it out to the stop position, raise the front edge, then lift out. Reverse the steps to replace a rack. Always broil with both the broiler and the oven doors closed.

When broiling, preheat the oven for 5 minutes before putting food in unless recommended otherwise in the recipe. Position food on grid in a broiler pan.

- To avoid damage to the broiler, do not step on or apply weight to the broiler door while it is open.
- Preheat the broiler before use. Completely close broiler door during broiling.
- Do not use broiler cavity for storage.
- Broiling uses direct radiant heat to cook food. Changing the temperature when broiling allows more precise control when cooking. The lower the temperature, the slower the cooking. Thicker cuts and unevenly shaped pieces of meat, fish and poultry may cook better at lower broiling temperatures
- For best results, use a broiler pan and grid. It is designed to drain juices and help avoid spatter and smoke.

If you would like to purchase a broiler pan, one may be ordered. Please refer to the cover for contact information. Ask for Part Number 4396923.

- Pull out the rack to the stop position before turning or removing food. Use tongs to turn food to avoid the loss of juices. Very thin cuts of fish, poultry or meat may not need to be turned.

### To Broil:

1. Open the broiler door and pull the rack out to the stop position.
2. Place food on a grid in a broiler pan, then place it in the center of the oven rack.
3. Push the oven rack back to the original position. Close the door to ensure proper broiling temperature.
4. Press **BROIL**.  
The **BROIL** indicator light will light up.
5. Press **START**.  
The indicator light will light up. The temperature setting can be changed at any time during broiling. If broiling while the Timer is counting down, the set broiling temperature can be displayed for 5 seconds by touching **BROIL**.
6. Press **OFF/CANCEL** or **CANCEL/OFF** when finished broiling.

---

# RANGE CARE

---

## General Cleaning

**IMPORTANT:** Before cleaning, make sure all controls are off and the oven and cooktop are cool. Always follow label instructions on cleaning products. Do not wipe down any of the inside surfaces until the oven has completely cooled down. To avoid breaking the glass, do not apply a cool damp cloth to the inner door glass before it has completely cooled.

Soap, water and a soft cloth or sponge are suggested first unless otherwise noted.

---

### EXTERIOR PORCELAIN ENAMEL SURFACES (on some models)

---

Food spills containing acids, such as vinegar and tomato, should be cleaned as soon as the entire appliance is cool. These spills may affect the finish.

#### Cleaning Method:

- Glass cleaner, mild liquid cleaner or nonabrasive scrubbing pad:  
Gently clean around the model and serial number plate because scrubbing may remove numbers.
- Affresh® Kitchen and Appliance Cleaner Part Number W10355010 (not included):  
See the “Assistance or Service” section to order.

---

### COOKTOP CONTROLS

---

To avoid damage to the cooktop controls, do not use steel wool, abrasive cleansers or oven cleaner.

To avoid damage, do not soak knobs.

When replacing knobs, make sure knobs are in the Off position.

On some models, do not remove seals under knobs.

#### Cleaning Method:

- Warm, soapy water:  
Pull knobs straight away from control panel to remove. Gently clean cooktop controls because scrubbing may remove graphics or text.

---

### CONTROL PANEL

---

To avoid damage to the control panel, do not use abrasive cleaners, steel-wool pads, gritty washcloths or abrasive paper towels.

#### Cleaning Method:

- Glass cleaner and soft cloth or sponge:  
Apply glass cleaner to soft cloth or sponge, not directly on panel. Gently clean control panel because scrubbing may remove graphics or text.
- Affresh® Kitchen and Appliance Cleaner Part Number W10355010 (not included):  
See the “Assistance or Service” section to order.

---

### PORCELAIN-COATED GRATES AND CAPS

---

Food spills containing acids, such as vinegar and tomato, should be cleaned as soon as the cooktop, grates and caps are cool. These spills may affect the finish.

To avoid chipping, do not bang grates and caps against each other or hard surfaces such as cast iron cookware.

Do not reassemble caps on burners while they are wet.

#### Cleaning Method:

- Nonabrasive plastic scrubbing pad and mildly abrasive cleanser:  
Clean as soon as cooktop, grates and caps are cool.
- Dishwasher (grates only, not caps):  
Use the most aggressive cycle. Cooked-on soils should be soaked or scrubbed before going into a dishwasher.
- Gas Grate and Drip Pan Cleaner Part Number 31617: See the “Assistance or Service” section to order.

---

### SURFACE BURNERS

---

See the “Surface Burners” section.

---

### OVEN DOOR EXTERIOR

---

#### Cleaning Method:

- Glass cleaner and a soft cloth or sponge:  
Apply glass cleaner to soft cloth or sponge, not directly on panel. Do not soak soft cloth or sponge.
- Affresh® Kitchen and Appliance Cleaner Part Number W10355010 (not included):  
See the “Assistance or Service” section to order.

---

### OVEN CAVITY

---

Food spills should be cleaned when oven cools. At high temperatures, foods react with porcelain and staining, etching, pitting or faint white spots can result.

On some models, the oven door can be removed. See the “Oven Door” section first.

#### Cleaning Method:

- Steel-wool pad
- Oven cleaner: Follow product label instructions.

---

### OVEN RACKS AND ROASTING RACKS

---

#### Cleaning Method:

- Steel-wool pad

---

## Oven Light

The oven light is a standard 40 W appliance bulb. When the oven door is closed, press OVEN LIGHT to turn on the light.

Before replacing, make sure the oven and cooktop are cool and the control knobs are off.

#### To Replace:

1. Unplug range or disconnect power.
2. Turn bulb counterclockwise to remove from socket.
3. Replace bulb.
4. Plug in range or reconnect power.

---

## Oven Door

For normal range use, it is not suggested to remove the oven door. However, if removal is necessary, make sure the oven is off and cool. Then, follow these instructions. The oven door is heavy.

### To Remove:

1. Open the oven door. Insert the hinge locks into both hinge hangers. See following illustration. Do not unlock hinges while the door is removed from the range.

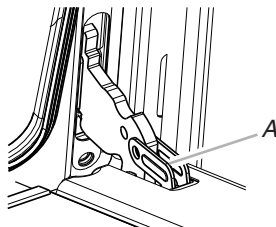

A. Hinge lock

2. Grasp the door on the sides with your fingers on the front of the door and your thumbs on the inside surface.

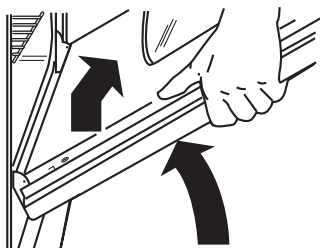

3. Pull door straight up, then toward you. Do not unlock the hinges until the door is replaced on the range.

### To Replace:

1. Grasp the door on the sides with your fingers on the front of the door and your thumbs on the inside surface.

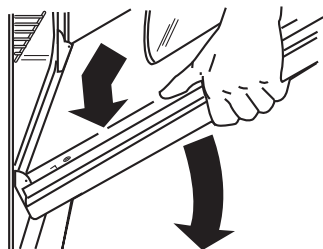

2. Hold oven door so that the top edge of each door slot is horizontal. Insert door hinge into the hinge slots.

3. Tilt top of door toward range. Insert bottom door hinge notch down onto front frame edge.

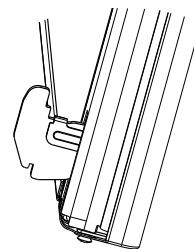

4. Open the door completely and unlock the hinges.

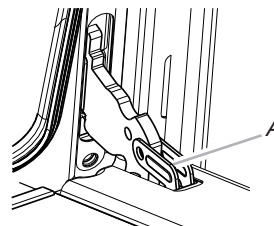

A. Hinge lock

5. Close the door slowly to assure door side panel clearance and proper hinge engagement.

---

## Removing the Oven Bottom

The oven bottom can be removed for standard cleaning of the oven.

Before cleaning, make sure the oven is completely cool.

### To Remove:

1. Remove the oven racks.
2. Place fingers in the slots in the bottom panel.

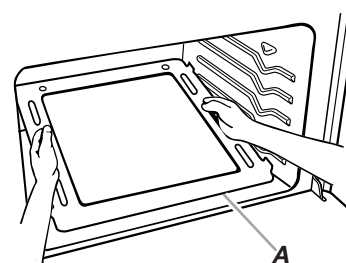

A. Lip

3. Lift the rear of the panel up and back. The lip at the front of the panel should clear the front frame of the oven cavity.
4. Lift the bottom up and out.

### To Replace:

Reverse the previous steps 1-4.

# TROUBLESHOOTING

Try the solutions suggested here first in order to avoid the cost of an unnecessary service call.

## Nothing will operate

### **⚠ WARNING**



#### **Electrical Shock Hazard**

**Plug into a grounded 3 prong outlet.**

**Do not remove ground prong.**

**Do not use an adapter.**

**Do not use an extension cord.**

**Failure to follow these instructions can result in death, fire, or electrical shock.**

- **Is the power outlet properly wired and polarized?**  
Try another outlet to check for proper wiring and polarity.
- **Is the power supply cord unplugged?**  
Plug into a properly grounded 3 prong outlet.
- **Has a household fuse been blown, or has a circuit breaker tripped?**  
Replace the fuse or reset the circuit breaker. If the problem continues, call an electrician.
- **Is the main or regulator gas shutoff valve in the off position?**  
See the Installation Instructions.
- **Is the range properly connected to the gas supply?**  
Contact a trained repair specialist or see the Installation Instructions.

## Surface burners will not operate

- **Is this the first time the surface burners have been used?**  
Turn on any one of the surface burner knobs to release air from the gas lines.
- **Is the control knob set correctly?**  
Push in knob before turning to a setting.
- **Are the burner ports clogged?**  
See the "Surface Burners" section.

## Surface burner flames are uneven, yellow and/or noisy

- **Are the burner ports clogged?**  
See the "Surface Burners" section.
- **Are the burner caps positioned properly?**  
See the "Surface Burners" section.
- **Is the air/gas mixture correct?**  
Contact a designated service technician to check the air/gas mixture, or see the Installation Instructions.
- **Is propane gas being used?**  
The appliance may have been converted improperly. Contact a trained repair specialist.

## Surface burner makes popping noises

- **Is the burner wet?**  
Let it dry.

## Gas range noises during Bake and Broil operations

Noises that may be heard during the Bake and Broil operations: Whooshing, Poof, Clicking, Snaps, Pop

These sounds are normal operational noises that can be heard each time the Bake or Broil burners ignite during the cycle.

- A pop can be heard when the gas valve is opening or cycling on and will make a single pop when it snaps open from the solenoid. It sounds similar to a suction cup being pulled off of a piece of glass.
- The igniters will click several times until the flame is detected. These are short clicking sounds like tapping a nail onto a piece of glass.
- A whooshing or poof sound is heard when the Bake or Broil burner ignites.
- On some models, a clicking sound can be heard when the convection fan relay cycles on and off.

## Cookware not level on cooktop

- **Is the range level?**  
Level the range. See the Installation Instructions.
- **Is the proper cookware being used?**  
Use cookware with a flat bottom. See the "Cookware" section.

## Excessive heat around cookware on cooktop

- **Is the cookware the proper size?**  
Use cookware about the same size as the surface cooking area, element or surface burner. Cookware should not extend more than 1/2" (1.3 cm) outside the cooking area.

## Oven will not operate

- **Is the power outlet properly wired and polarized?**  
Try another outlet to check for proper wiring and polarity.
- **Is this the first time the oven has been used?**  
Turn any one of the surface burner knobs on to release air from the gas lines.
- **Is the electronic oven control set correctly?**  
See the "Electronic Oven Control" section.
- **On some models, is the Control Lock set?**  
See the "Control Lock" section.
- **Is the main or regulator gas shutoff in the off position?**  
Contact a designated service technician or see the Installation Instructions.

## Oven makes muffled ticking noise when in use

- This is normal and occurs when the oven burner cycles on and off to hold the set oven temperature.

---

### Oven burner flames are uneven, yellow and/or noisy

---

- **Is propane gas being used?**  
The appliance may have been converted improperly. Contact a trained repair specialist.
- **Is the air/gas mixture correct?**  
Contact a designated service technician to check the air/gas mixture or see the Installation Instructions.

---

### Oven temperature too high or too low

---

- **Does the oven temperature calibration need adjustment?**  
See the "Oven Temperature Control" section.

---

### Display shows messages

---

- **Is the display showing a flashing time?**  
There has been a power failure. Press OFF/CANCEL or CANCEL/OFF to clear the display. Reset the clock, if needed. See the "Clock" section.
- **Is the display showing "F" followed by a number?**  
Press OFF/CANCEL or CANCEL/OFF to clear the display. If an "F" code appears again, contact a trained repair specialist.

---

### Cooktop cooking results not what expected

---

- **Is the proper cookware being used?**  
See the "Cookware" section.
- **Is the control knob set to the proper heat level?**  
See the "Cooktop Controls" section.

---

### Baking results not what expected

---

- **Is the range level?**  
Level the range. See the Installation Instructions.
- **Does the oven temperature calibration need adjustment?**  
See the "Oven Temperature Control" section.
- **Was the oven preheated?**  
Wait for oven to preheat before placing food in oven.
- **Is the proper oven temperature calibration set?**  
See the "Oven Temperature Control" section.

- **Is the proper bakeware being used?**  
See the "Bakeware" section.
- **Are the racks positioned properly?**  
See the "Positioning Racks and Bakeware" section.
- **Is there proper air circulation around bakeware?**  
See the "Positioning Racks and Bakeware" section.
- **Is the batter evenly distributed in the pan?**  
Make sure batter is level in the pan.
- **Are baked items too brown on the bottom?**  
Decrease oven temperature 10° F to 30° F (5°C to 15°C).
- **Are crust edges browning early?**  
Use aluminum foil to cover the edge of the crust and/or reduce baking temperature.

---

### Slow baking or roasting

---

- **Was the oven preheated?**  
Wait for oven to preheat before placing food in oven.
- **Is there proper air circulation around bakeware?**  
See the "Positioning Racks and Bakeware" section.
- **Does the oven temperature calibration need adjustment?**  
See the "Oven Temperature Control" section.
- **Is the proper length of time being used?**  
Increase baking or roasting time.
- **Is the proper temperature set?**  
Increase temperature by 25°F (15°C).
- **Has the oven door been opened while cooking?**  
Oven peeking releases oven heat and can result in longer cooking times.

---

### Broiler burner fails to light

---

- **Is the ignition system broken?**  
Contact a designated service technician to replace it.
- **Has a household fuse been blown, or has a circuit breaker tripped?**  
Replace the fuse or reset the circuit breaker. If the problem continues, call an electrician.

---

# ASSISTANCE OR SERVICE

---

Before calling for assistance or service, please check "Troubleshooting." It may save you the cost of a service call. If you still need help, follow the instructions below.

When calling, please know the purchase date and the complete model and serial number of your appliance. This information will help us to better respond to your request.

## If You Need Replacement Parts

If you need to order replacement parts, we recommend that you use only factory specified replacement parts. Factory specified replacement parts will fit right and work right because they are made with the same precision used to build every new Amana® appliance.

To locate factory specified replacement parts in your area, call us or your nearest designated service center.

---

## In the U.S.A.

For assistance, installation or service call Amana® Appliances toll free: **1-866-616-2664** or visit **www.amana.com**.

### Our consultants provide assistance with:

- Features and specifications on our full line of appliances.
- Installation information.
- Use and maintenance procedures.
- Accessory and repair parts sales.
- Specialized customer assistance (Spanish speaking, hearing impaired, limited vision, etc.).
- Referrals to local dealers, repair parts distributors and service companies. Amana designated service technicians are trained to fulfill the product warranty and provide after-warranty service, anywhere in the United States.

To locate the Amana designated service company in your area, you can also look in your telephone directory Yellow Pages.

### For further assistance

If you need further assistance, you can write to Amana® Appliances with any questions or concerns at:

Amana Brand Home Appliances  
Customer eXperience Center  
553 Benson Road  
Benton Harbor, MI 49022-2692

Please include a daytime phone number in your correspondence.

---

## In Canada

In Canada, for assistance, installation or service call Amana® Appliances toll free: **1-800-807-6777** or visit **www.amanacanada.ca**.

### Our consultants provide assistance with:

- Features and specifications on our full line of appliances.
- Use and maintenance procedures.
- Accessory and repair parts sales.
- Referrals to local dealers, repair parts distributors, and service companies. Amana Canada LP designated service technicians are trained to fulfill the product warranty and provide after-warranty service, anywhere in Canada.

### For further assistance

If you need further assistance, you can write to Amana® Canada Appliances with any questions or concerns at:

Amana Brand Home Appliances  
Customer eXperience Centre  
200 - 6750 Century Ave.  
Mississauga, Ontario L5N 0B7

Please include a daytime phone number in your correspondence.

---

## Accessories

### Affresh® Stainless Steel Cleaner

(stainless steel models)

Order Part Number W10355016

### Affresh® Kitchen and Appliance Cleaner

Order Part Number W10355010

### Gas Grate and Drip Pan Cleaner

Order Part Number 31617

### Broiler Pan

Order Part Number 4396923

