

# ZAZ-M90DS ZAZ-E42DS

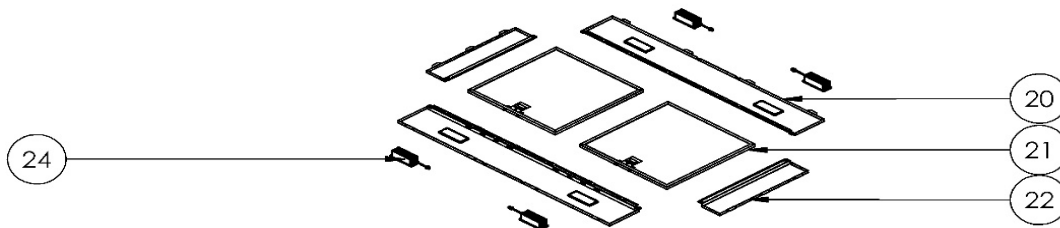
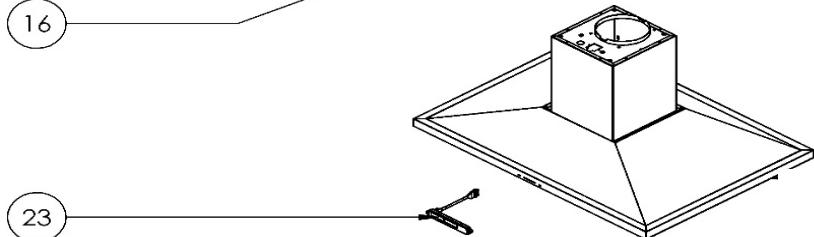
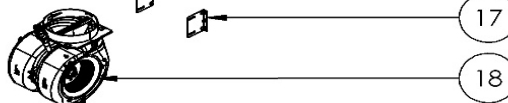
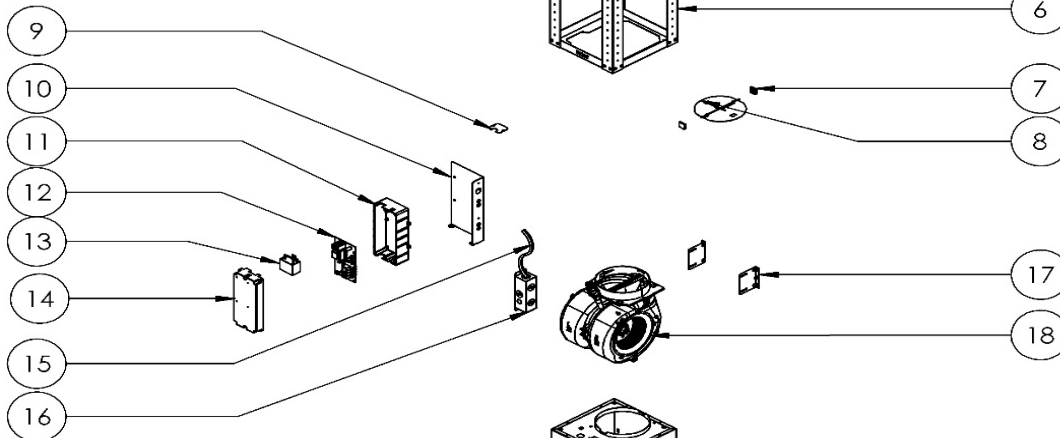
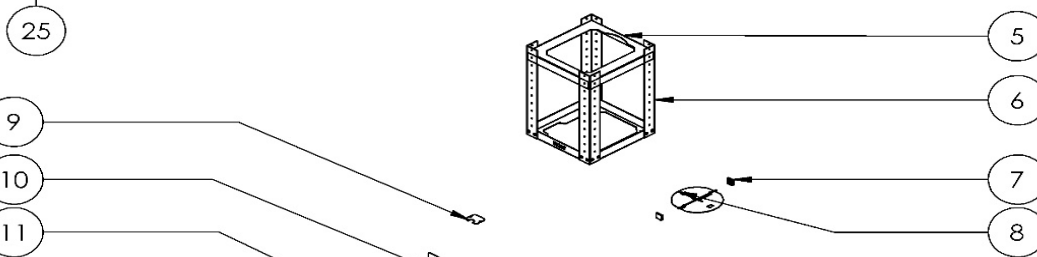
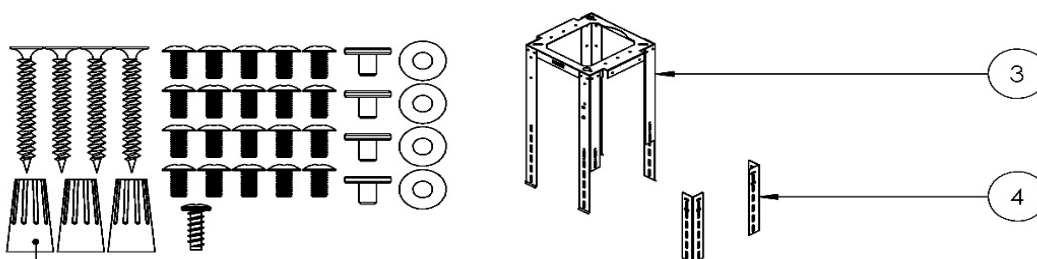
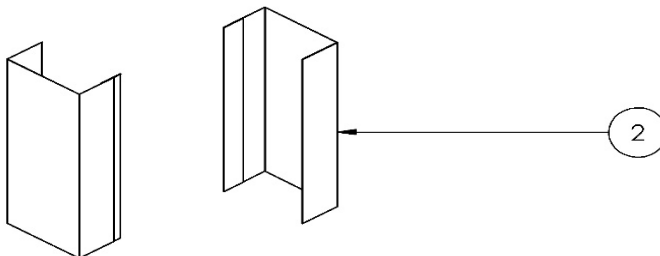
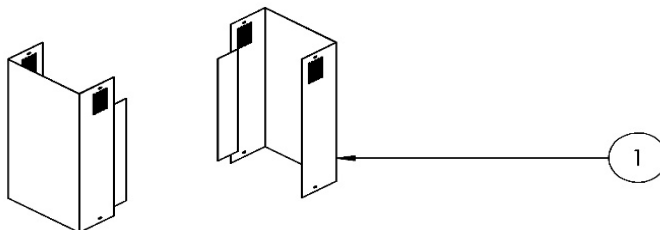

# Anzio Island

**ZAZ-M90DS, ZAZ-E42DS**

| <b>Ref #</b> | <b>Part #</b> | <b>Description</b>           | <b>Qty.</b> |
|--------------|---------------|------------------------------|-------------|
| 1            | 50050168      | Upper Duct Cover             | 2           |
| 2            | 50050163      | Lower Duct Cover             | 2           |
| 3            | 54110106      | Upper Support Frame          | 1           |
| 4            | 54110132      | Upper Support Frame Bracket  | 2           |
| 5            | 54110073      | Support Frame Square Bracket | 1           |
| 6            | 54110074      | Lower Support Frame          | 1           |
| 7            | 50180002      | Damper Clip                  | 2           |
| 8            | 54060004      | 6 Inch Round Damper          | 1           |
| 9            | 54210025      | Electrical Hole Cover        | 1           |
| 10           | 54140330      | Electronics Bracket          | 1           |
| 11           | 56200051      | Component Box                | 1           |
| 12           | 11010151      | Control Board                | 1           |
| 13           | 12050021      | Capacitor                    | 1           |
| 14           | 56210024      | Component Box Cover          | 1           |
| 15           | 11030139      | Electrical Cord              | 1           |
| 16           | 56200080      | Electrical Box               | 1           |
| 17           | 54140331      | Motor Bracket                | 2           |
| 18           | 12120089      | Motor                        | 1           |
| 20           | 50110383      | Light Panel (ZAZ-M90DS)      | 2           |
| 20           | 50110384      | Light Panel (ZAZ-E42DS)      | 2           |
| 21           | 50200059      | Aluminum Mesh Filter         | 2           |
| 22           | 50120106      | Side Panel (ZAZ-M90DS)       | 2           |
| 22           | 50120107      | Side Panel (ZAZ-E42DS)       | 2           |
| 23           | 11000168      | Switch Assembly              | 1           |
| 24           | Z0B0048       | LumiLight LED, 6W            | 4           |
| 25           | 05000120      | Hardware Packet              | 1           |