



---

## ELECTRIC RANGE

### Use & Care Guide

For questions about features, operation/performance, parts, accessories or service, call: **1-800-253-1301**

or visit our website at...  
[www.whirlpool.com](http://www.whirlpool.com)

---

Table of Contents .....	2
-------------------------	---

---

To the installer: Please leave this instruction book with the range.

To the consumer: Please read and keep this book for future reference.

# TABLE OF CONTENTS

<b>RANGE SAFETY</b> .....	<b>3</b>	<b>OVEN USE</b> .....	<b>15</b>
The Anti-Tip Bracket .....	3	Aluminum Foil .....	15
<b>PARTS AND FEATURES</b> .....	<b>5</b>	Positioning Racks and Bakeware .....	15
<b>COOKTOP USE</b> .....	<b>8</b>	Split Oven Rack (on some models).....	16
Cooktop Controls.....	8	Bakeware.....	16
Dual Cooking Zone (on some models) .....	8	Meat Thermometer.....	16
Warm Zone Element (on some models) .....	8	Oven Vent.....	17
Ceramic Glass (on some models).....	9	Baking and Roasting .....	17
Coil Elements and Burner Bowls (on some models).....	9	Choice Bake® Function (on some models) .....	17
Lift-up Cooktop (on some models).....	10	Broiling.....	18
Home Canning .....	10	Convection Cooking.....	18
Cookware .....	10	Hold Warm Feature (on some models) .....	20
<b>ELECTRONIC OVEN CONTROLS</b> .....	<b>11</b>	Timed Cooking (on some models) .....	21
Display .....	13	Sequence Programming .....	22
Start .....	13	Warming Drawer (on some models).....	23
Off/Cancel .....	13	<b>RANGE CARE</b> .....	<b>24</b>
Clock .....	13	Self-Cleaning Cycle (on some models).....	24
Range Lights .....	13	General Cleaning .....	25
Tones.....	14	Oven Light .....	27
Fahrenheit and Celsius.....	14	Oven Door .....	28
Timer.....	14	Storage Drawer .....	28
Oven Control Lockout (on some models).....	14	Warming Drawer (on some models).....	29
12-Hour Shut-Off .....	15	<b>TROUBLESHOOTING</b> .....	<b>29</b>
Oven Temperature Control .....	15	<b>ASSISTANCE OR SERVICE</b> .....	<b>31</b>
		In the U.S.A. ....	31
		<b>WARRANTY</b> .....	<b>32</b>

# RANGE SAFETY

## Your safety and the safety of others are very important.

We have provided many important safety messages in this manual and on your appliance. Always read and obey all safety messages.



This is the safety alert symbol.

This symbol alerts you to potential hazards that can kill or hurt you and others.

All safety messages will follow the safety alert symbol and either the word "DANGER" or "WARNING."

These words mean:

**⚠ DANGER**

**You can be killed or seriously injured if you don't immediately follow instructions.**

**⚠ WARNING**

**You can be killed or seriously injured if you don't follow instructions.**

All safety messages will tell you what the potential hazard is, tell you how to reduce the chance of injury, and tell you what can happen if the instructions are not followed.

## The Anti-Tip Bracket

The range will not tip during normal use. However, the range can tip if you apply too much force or weight to the open door without the anti-tip bracket fastened down properly.



**⚠ WARNING**

### Tip Over Hazard

**A child or adult can tip the range and be killed.**

**Connect anti-tip bracket to rear range foot.**

**Reconnect the anti-tip bracket, if the range is moved.**

**See the installation instructions for details.**

**Failure to follow these instructions can result in death or serious burns to children and adults.**

### Anti-Tip Bracket

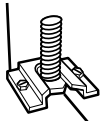

Range Foot

**Making sure the anti-tip bracket is installed:**

- **Slide range forward.**
- **Look for the anti-tip bracket securely attached to floor.**
- **Slide range back so rear range foot is under anti-tip bracket.**

The California Safe Drinking Water and Toxic Enforcement Act requires the Governor of California to publish a list of substances known to the State of California to cause cancer, birth defects, or other reproductive harm, and requires businesses to warn of potential exposure to such substances.

**WARNING:** This product contains a chemical known to the State of California to cause cancer, birth defects, or other reproductive harm.

This appliance can cause low-level exposure to some of the substances listed, including benzene, formaldehyde, carbon monoxide, and toluene.

# IMPORTANT SAFETY INSTRUCTIONS

**WARNING:** To reduce the risk of fire, electrical shock, injury to persons, or damage when using the range, follow basic precautions, including the following:

- **WARNING:** TO REDUCE THE RISK OF TIPPING OF THE RANGE, THE RANGE MUST BE SECURED BY PROPERLY INSTALLED ANTI-TIP DEVICES. TO CHECK IF THE DEVICES ARE INSTALLED PROPERLY, SLIDE RANGE FORWARD, LOOK FOR ANTI-TIP BRACKET SECURELY ATTACHED TO FLOOR, AND SLIDE RANGE BACK SO REAR RANGE FOOT IS UNDER ANTI-TIP BRACKET.
- **CAUTION:** Do not store items of interest to children in cabinets above a range or on the backguard of a range – children climbing on the range to reach items could be seriously injured.
- Proper Installation – Be sure the range is properly installed and grounded by a qualified technician.
- Never Use the Range for Warming or Heating the Room.
- Do Not Leave Children Alone – Children should not be left alone or unattended in area where the range is in use. They should never be allowed to sit or stand on any part of the range.
- Wear Proper Apparel – Loose-fitting or hanging garments should never be worn while using the range.
- User Servicing – Do not repair or replace any part of the range unless specifically recommended in the manual. All other servicing should be referred to a qualified technician.
- Storage in or on the Range – Flammable materials should not be stored in an oven or near surface units.
- Do Not Use Water on Grease Fires – Smother fire or flame or use dry chemical or foam-type extinguisher.
- Use Only Dry Potholders – Moist or damp potholders on hot surfaces may result in burns from steam. Do not let potholder touch hot heating elements. Do not use a towel or other bulky cloth.
- DO NOT TOUCH SURFACE UNITS OR AREAS NEAR UNITS – Surface units may be hot even though they are dark in color. Areas near surface units may become hot enough to cause burns. During and after use, do not touch, or let clothing or other flammable materials contact surface units or areas near units until they have had sufficient time to cool. Among those areas are the cooktop and surfaces facing the cooktop.
- Use Proper Pan Size – The range is equipped with one or more surface units of different size. Select utensils having flat bottoms large enough to cover the surface unit heating element. The use of undersized utensils will expose a portion of the heating element to direct contact and may result in ignition of clothing. Proper relationship of utensil to burner will also improve efficiency.
- Never Leave Surface Units Unattended at High Heat Settings – Boilover causes smoking and greasy spillovers that may ignite.
- Make Sure Reflector Pans or Drip Bowls Are in Place – Absence of these pans or bowls during cooking may subject wiring or components underneath to damage.

- Protective Liners – Do not use aluminum foil to line surface unit drip bowls or oven bottoms, except as suggested in the manual. Improper installation of these liners may result in a risk of electric shock, or fire.
- Glazed Cooking Utensils – Only certain types of glass, glass/ceramic, ceramic, earthenware, or other glazed utensils are suitable for range-top service without breaking due to the sudden change in temperature.
- Utensil Handles Should Be Turned Inward and Not Extend Over Adjacent Surface Units – To reduce the risk of burns, ignition of flammable materials, and spillage due to unintentional contact with the utensil, the handle of a utensil should be positioned so that it is turned inward, and does not extend over adjacent surface units.
- Do Not Soak Removable Heating Elements – Heating elements should never be immersed in water.
- Do Not Cook on Broken Cooktop – If cooktop should break, cleaning solutions and spillovers may penetrate the broken cooktop and create a risk of electric shock. Contact a qualified technician immediately.
- Clean Cooktop With Caution – If a wet sponge or cloth is used to wipe spills on a hot cooking area, be careful to avoid steam burn. Some cleaners can produce noxious fumes if applied to a hot surface.
- Use Care When Opening Door – Let hot air or steam escape before removing or replacing food.
- Do Not Heat Unopened Food Containers – Build-up of pressure may cause container to burst and result in injury.
- Keep Oven Vent Ducts Unobstructed.
- Placement of Oven Racks – Always place oven racks in desired location while oven is cool. If rack must be moved while oven is hot, do not let potholder contact hot heating element in oven.
- DO NOT TOUCH HEATING ELEMENTS OR INTERIOR SURFACES OF OVEN – Heating elements may be hot even though they are dark in color. Interior surfaces of an oven become hot enough to cause burns. During and after use, do not touch, or let clothing or other flammable materials contact heating elements or interior surfaces of oven until they have had sufficient time to cool. Other surfaces of the appliance may become hot enough to cause burns – among these surfaces are oven vent openings and surfaces near these openings, oven doors, and windows of oven doors.

## For self-cleaning ranges –

- Do Not Clean Door Gasket – The door gasket is essential for a good seal. Care should be taken not to rub, damage, or move the gasket.
- Do Not Use Oven Cleaners – No commercial oven cleaner or oven liner protective coating of any kind should be used in or around any part of the oven.
- Clean Only Parts Listed in Manual.
- Before Self-Cleaning the Oven – Remove broiler pan and other utensils.

## For units with ventilating hood –

- Clean Ventilating Hoods Frequently – Grease should not be allowed to accumulate on hood or filter.
- When flambeing foods under the hood, turn the fan on.

## SAVE THESE INSTRUCTIONS

# PARTS AND FEATURES

This manual covers several different models. The range you have purchased may have some or all of the parts and features listed. The location and appearance of the features shown here may not match those of your model.

## Control Panels

### Style 1

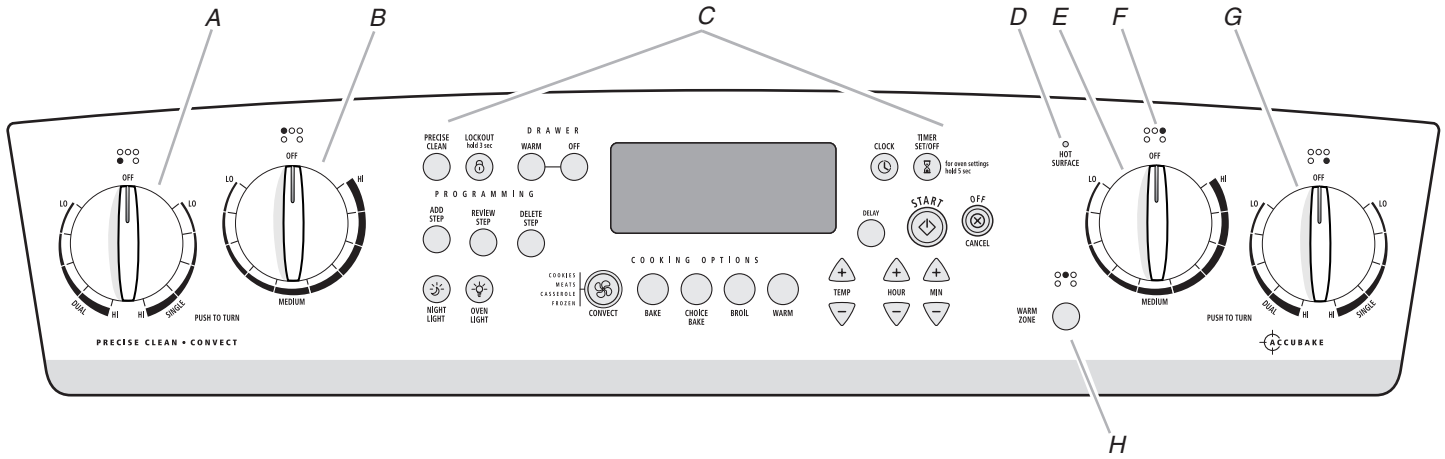

- A. Left front control knob
- B. Left rear control knob
- C. Electronic oven control

- D. Hot surface indicator light
- E. Right rear control knob
- F. Surface cooking area locator

- G. Right front control knob
- H. Warm zone button

### Style 2

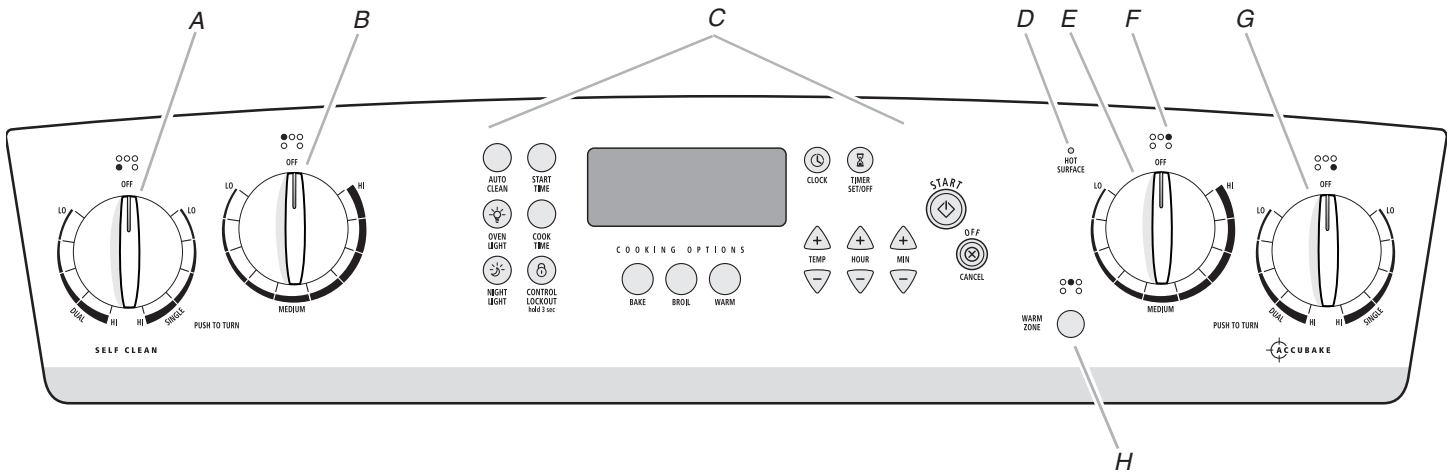

- A. Left front control knob
- B. Left rear control knob
- C. Electronic oven control

- D. Hot surface indicator light
- E. Right rear control knob
- F. Surface cooking area locator

- G. Right front control knob
- H. Warm zone button

**Style 3**

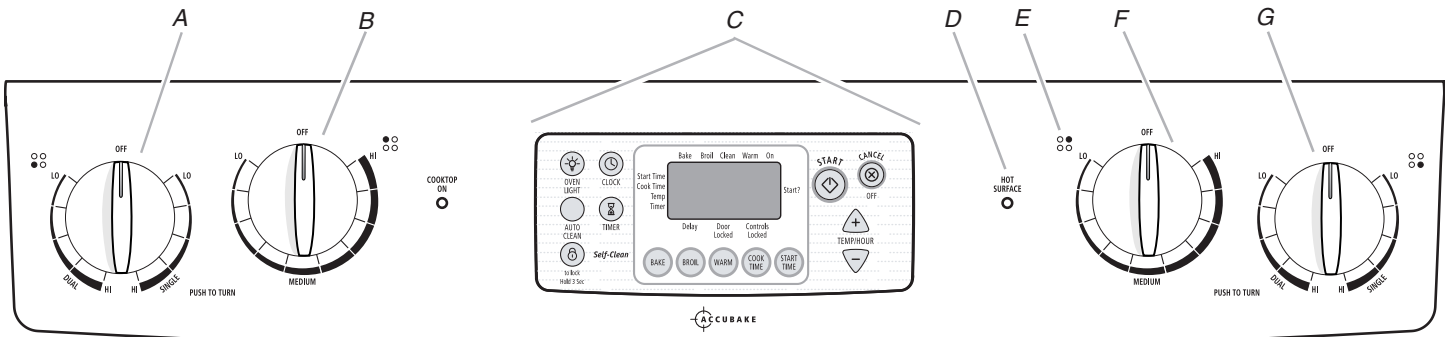

A. Left front control knob  
B. Left rear control knob  
C. Electronic oven control

D. Hot surface indicator light  
E. Surface cooking area locator

F. Right rear control knob  
G. Right front control knob

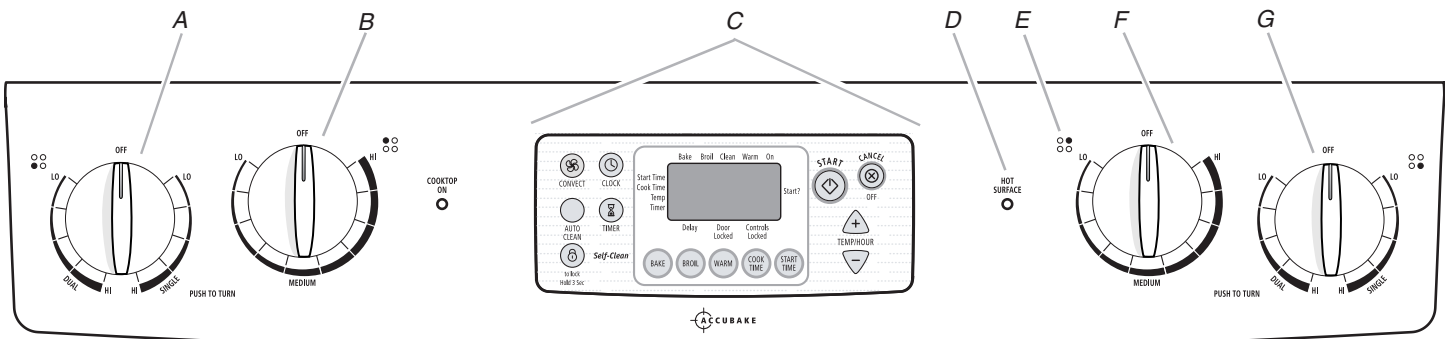

A. Left front control knob  
B. Left rear control knob  
C. Electronic oven control

D. Hot surface indicator light  
E. Surface cooking area locator

F. Right rear control knob  
G. Right front control knob

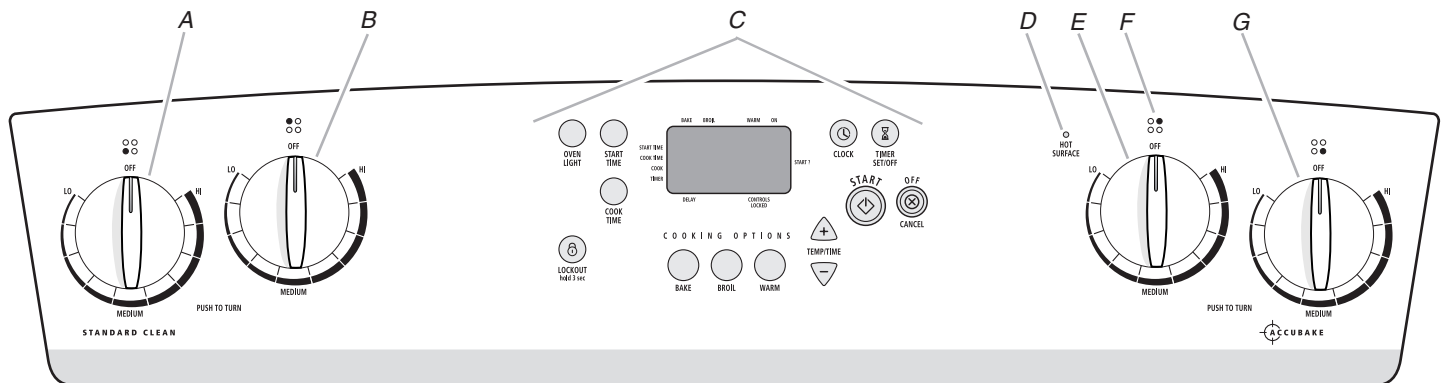

A. Left front control knob  
B. Left rear control knob  
C. Electronic oven control

D. Hot surface indicator light  
E. Right rear control knob

F. Surface cooking area locator  
G. Right front control knob

## Style 4

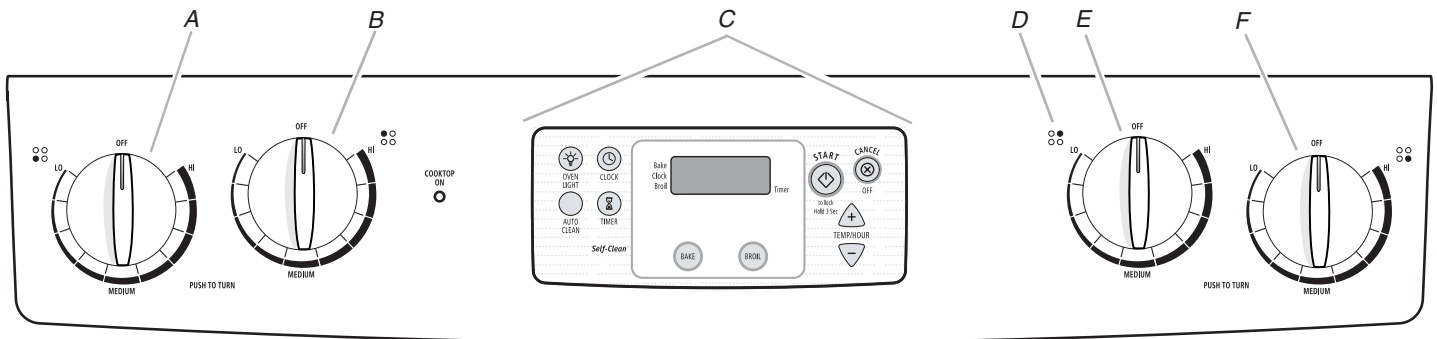

A. Left front control knob  
B. Left rear control knob

C. Electronic oven control  
D. Surface cooking area locator

E. Right rear control knob  
F. Right front control knob

## Range

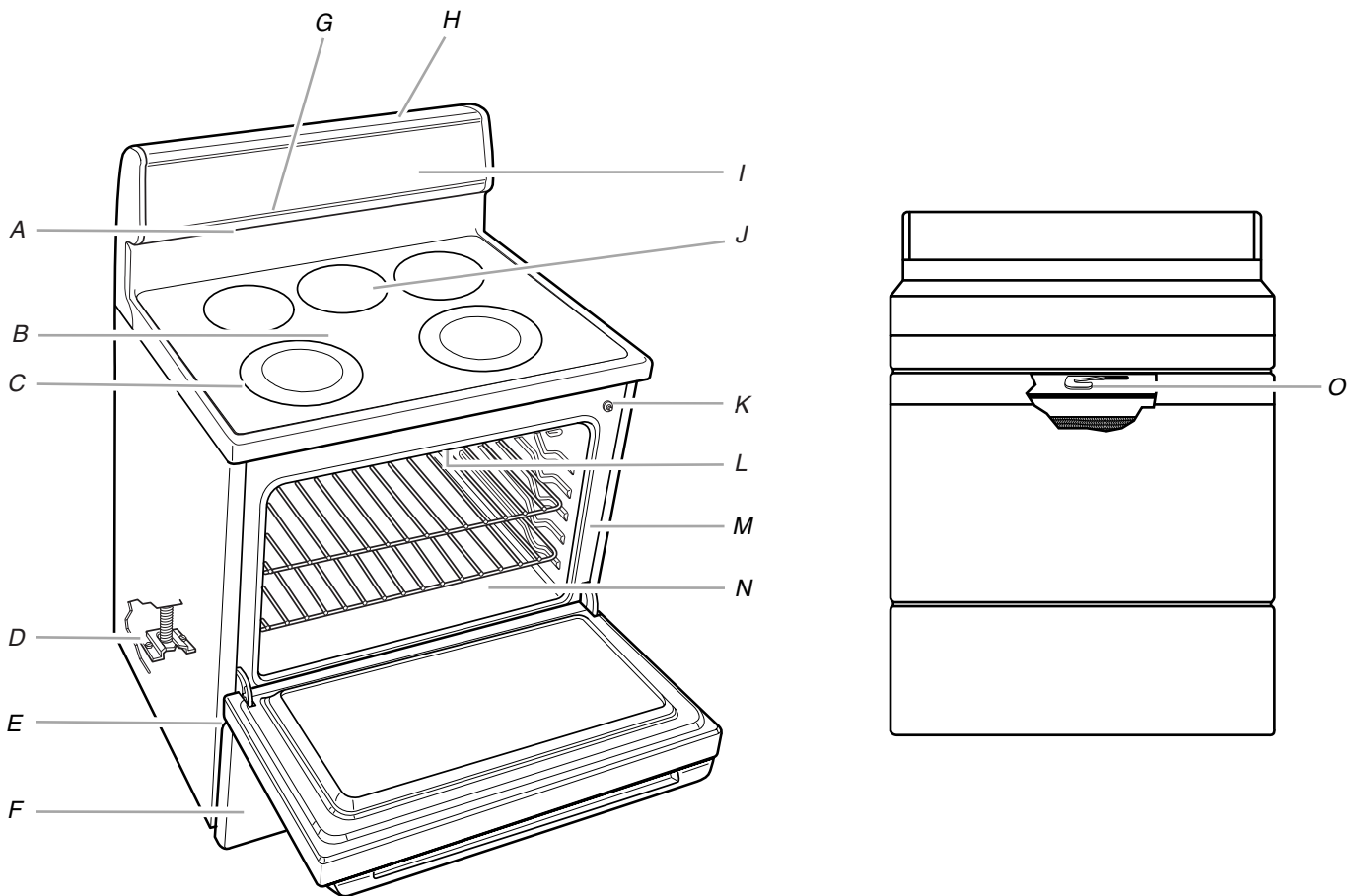

A. Oven vent (on ceramic glass models)  
B. Ceramic glass (on some models)  
C. Dual element (on some models)  
D. Anti-tip bracket  
E. Model and serial number plate (behind left side of storage drawer)

F. Storage drawer (on some models) or warming drawer (on some models)  
G. Console night light (on some models)  
H. Oven light switch (on some models)  
I. Console panel  
J. Warm zone element (on some models)

K. Automatic oven light switch  
L. Broil element (not shown)  
M. Gasket  
N. Bake element (hidden on some models)  
O. Self-clean latch

**Parts and Features not shown**  
Coil elements (on some models)  
Oven door window  
Oven light  
Broiler pan and grid (on some models)  
Roasting rack (on some models)  
Storage drawer liner (on some models)

# COOKTOP USE

## Cooktop Controls

### **! WARNING**



#### Fire Hazard

**Turn off all controls when done cooking.**  
**Failure to do so can result in death or fire.**

The control knobs can be set to anywhere between HI and LO. Push in and turn to setting. Use the following chart as a guide when setting heat levels.

SETTING	RECOMMENDED USE
<b>HI</b>	<ul style="list-style-type: none"> <li>Start food cooking.</li> <li>Bring liquid to a boil.</li> </ul>
<b>Medium High</b> Between <b>MEDIUM</b> and <b>HI</b>	<ul style="list-style-type: none"> <li>Hold a rapid boil.</li> <li>Quickly brown or sear food.</li> </ul>
<b>MEDIUM</b>	<ul style="list-style-type: none"> <li>Maintain a slow boil.</li> <li>Fry or sauté foods.</li> <li>Cook soups, sauces and gravies.</li> </ul>
<b>Medium Low</b> Between <b>MEDIUM</b> and <b>LO</b>	<ul style="list-style-type: none"> <li>Stew or steam food.</li> <li>Simmer.</li> </ul>
<b>LO</b>	<ul style="list-style-type: none"> <li>Keep food warm.</li> <li>Melt chocolate or butter.</li> </ul>
<b>Warm Zone Element</b> (on some ceramic glass models)	<ul style="list-style-type: none"> <li>Keep cooked foods warm.</li> </ul>

**REMEMBER:** When range is in use or (on some models) during the Self-Cleaning cycle, the entire cooktop area may become hot.

## Dual Cooking Zone (on some models)

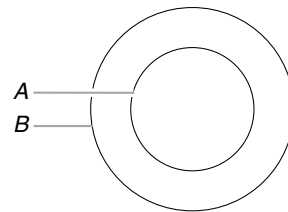

A. Single size (6" [15.24 cm])  
 B. Dual size (9" [22.86 cm])

The Dual Cooking Zone offers flexibility depending on the size of the cookware. Single size can be used in the same way as a regular element. The dual size combines both the single and outer element and is recommended for larger size cookware.

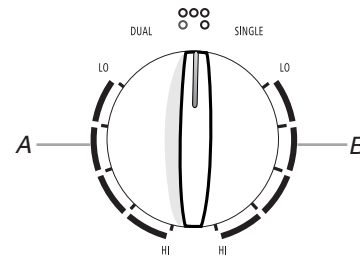

A. Dual  
 B. Single

### To Use DUAL:

1. Push in and turn the left front control knob counterclockwise to the DUAL zone anywhere between HI and LO.
2. Turn knob to vertical (off) when finished.

### To Use SINGLE:

1. Push in and turn the left front control knob clockwise to the SINGLE zone anywhere between HI and LO.
2. Turn knob to vertical (off) when finished.

## Warm Zone Element (on some models)

### **! WARNING**

#### Food Poisoning Hazard

**Do not let food sit for more than one hour before or after cooking.**

**Doing so can result in food poisoning or sickness.**

Use the Warm Zone element to keep cooked foods warm. One hour is the recommended maximum time to maintain food quality.

Do not use it to heat cold foods.

The Warm Zone element can be used alone or when any of the other surface cooking areas are being used.

The Warm Zone element area will not glow red when cycling on. However, its indicator light will glow as long as the Warm Zone element area is too hot to touch.

- Use only cookware and dishes recommended for oven and cooktop use.
- Cover all foods with a lid or aluminum foil. When warming baked goods, allow a small opening in the cover for moisture to escape.
- Do not use plastic wrap to cover food. Plastic wrap may melt.
- Use pot holders or oven mitts to remove food.



### To Use:

Push in WARM ZONE button to activate. Push again to turn off.

## Ceramic Glass

(on some models)

The surface cooking area will glow red when an element is on. It may cycle on and off to maintain the selected heat level.

It is normal for the surface of white or biscuit ceramic glass to appear to change color when surface cooking areas are hot. As the glass cools, it will return to its original color.

Cleaning off the cooktop before and after each use will help keep it free from stains and provide the most even heating. On cooktops with white or biscuit ceramic glass, soils and stains may be more visible, and may require more cleaning and care. Cooktop cleaner and a cooktop scraper are recommended. For more information, see "General Cleaning" section.

- Do not store jars or cans above the cooktop. Dropping a heavy or hard object onto the cooktop could crack the cooktop.
- Do not leave a hot lid on the cooktop. As the cooktop cools, air can become trapped between the lid and the cooktop, and the ceramic glass could break when the lid is removed.
- For foods containing sugar in any form, clean up all spills and soils as soon as possible. Allow the cooktop to cool down slightly. Then, while wearing oven mitts, remove the spills while the surface is still warm. If sugary spills are allowed to cool down, they can adhere to the cooktop and can cause pitting and permanent marks.
- Do not slide cookware or bakeware across the cooktop. Aluminum or copper bottoms and rough finishes on cookware or bakeware could leave scratches or marks on the cooktop.
- Do not cook popcorn in prepackaged aluminum containers on the cooktop. They could leave aluminum marks that cannot be removed completely.
- Do not allow objects that could melt, such as plastic or aluminum foil, to touch any part of the entire cooktop.
- Do not use the cooktop as a cutting board.

- Use cookware about the same size as the surface cooking area. Cookware should not extend more than ½" (1.3 cm) outside the area.

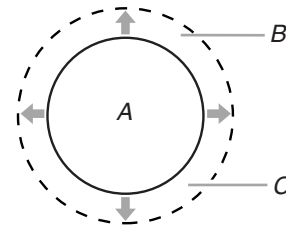

A. Surface cooking area  
B. Cookware/canner  
C. ½" (1.3 cm) Maximum overhang

- Use flat-bottomed cookware for best heat conduction and energy efficiency. Cookware with rounded, warped, ribbed or dented bottoms could cause uneven heating and poor cooking results.
- Determine flatness by placing the straight edge of a ruler across the bottom of the cookware. While you rotate the ruler, no space or light should be visible between it and the cookware.
- Cookware designed with slightly indented bottoms or small expansion channels can be used.
- Make sure the bottoms of pots and pans are clean and dry before using them. Residue and water can leave deposits when heated.
- Do not cook foods directly on the cooktop.

### Hot Surface Indicator Light

On coil element and ceramic glass models, the hot surface indicator light is located on the console panel.

The hot surface indicator light will glow as long as any surface cooking area is too hot to touch, even after the surface cooking area(s) is turned off.

## Coil Elements and Burner Bowls

(on some models)

Coil elements should be level for optimal cooking results. Burner bowls, when clean, reflect heat back to the cookware. They also help catch spills.

Cookware should not extend more than ½" (1.3 cm) over the coil element. If cookware is uneven or too large, it can produce excess heat, causing the burner bowl to change color. For more information, see the "General Cleaning" section.

**NOTE:** Before removing or replacing coil elements and burner bowls, make sure they are cool and the control knobs are in the Off position.

### To Remove:

1. Push in the edge of coil element toward the receptacle. Then lift it enough to clear the burner bowl.

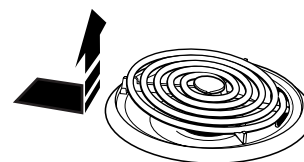

2. Pull the coil element straight away from the receptacle.

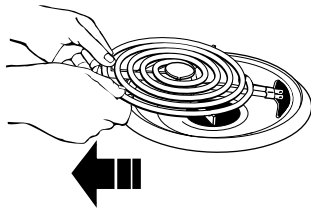

3. Lift out the burner bowl.

**To Replace:**

1. Line up openings in the burner bowl with the coil element receptacle.



2. Holding the coil element as level as possible, slowly push the coil element terminal into the receptacle.
3. When the terminal is pushed into the receptacle as far as it will go, push down the edge of the coil element opposite the receptacle.

**Lift-up Cooktop**  
(on some models)

The lift-up cooktop provides easy access for cleaning beneath. Do not drop the cooktop. Damage could occur to the finish and the cooktop frame. For more information, see the “General Cleaning” section.

**To Lift:**

Lift the cooktop by both front corners until the supports lock into place.

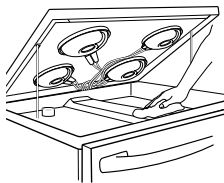

**To Replace:**

1. Lift the cooktop from both sides while pressing the support rods back to unlock them.
2. Slowly lower the cooktop into place.

**Home Canning**

When canning for long periods, alternate the use of surface cooking areas, elements or surface burners between batches. This allows time for the most recently used areas to cool.

- Center the canner on the grate or largest surface cooking area or element. On electric cooktops, canners should not extend more than 1/2" (1.3 cm) beyond the surface cooking area or element.
- Do not place canner on two surface cooking areas, elements or surface burners at the same time.

- On ceramic glass models, use only flat-bottomed canners.
- On coil element models, the installation of a Canning Unit Kit is recommended. If a kit is not installed, the life of the coil element will be shortened. See “Assistance or Service” for instructions on ordering.
- For instructions on ordering, contact your local U.S. Government Agricultural Department Extension Office. Companies that manufacture home canning products can also offer assistance.

**Cookware**

**IMPORTANT:** Do not leave empty cookware on a hot surface cooking area, element or surface burner.

Ideal cookware should have a flat bottom, straight sides and a well-fitting lid, and the material should be of medium-to-heavy thickness.

Rough finishes may scratch the cooktop or grates. Aluminum and copper may be used as a core or base in cookware. However, when used as a base they can leave permanent marks on the cooktop or grates.

Cookware material is a factor in how quickly and evenly heat is transferred, which affects cooking results. A nonstick finish has the same characteristics as its base material. For example, aluminum cookware with a nonstick finish will take on the properties of aluminum.

Cookware with nonstick surfaces should not be used under the broiler.

Use the following chart as a guide for cookware material characteristics.

COOKWARE	CHARACTERISTICS
<b>Aluminum</b>	<ul style="list-style-type: none"> <li>■ Heats quickly and evenly.</li> <li>■ Suitable for all types of cooking.</li> <li>■ Medium or heavy thickness is best for most cooking tasks.</li> </ul>
<b>Cast iron</b>	<ul style="list-style-type: none"> <li>■ Heats slowly and evenly.</li> <li>■ Good for browning and frying.</li> <li>■ Maintains heat for slow cooking.</li> </ul>
<b>Ceramic or Ceramic glass</b>	<ul style="list-style-type: none"> <li>■ Follow manufacturer's instructions.</li> <li>■ Heats slowly, but unevenly.</li> <li>■ Ideal results on low to medium heat settings.</li> </ul>
<b>Copper</b>	<ul style="list-style-type: none"> <li>■ Heats very quickly and evenly.</li> </ul>
<b>Earthenware</b>	<ul style="list-style-type: none"> <li>■ Follow manufacturer's instructions.</li> <li>■ Use on low heat settings.</li> </ul>
<b>Porcelain enamel-on-steel or cast iron</b>	<ul style="list-style-type: none"> <li>■ See stainless steel or cast iron.</li> </ul>
<b>Stainless steel</b>	<ul style="list-style-type: none"> <li>■ Heats quickly, but unevenly.</li> <li>■ A core or base of aluminum or copper on stainless steel provides even heating.</li> </ul>

# ELECTRONIC OVEN CONTROLS

## Style 1 - Electronic Oven Control (on some models)

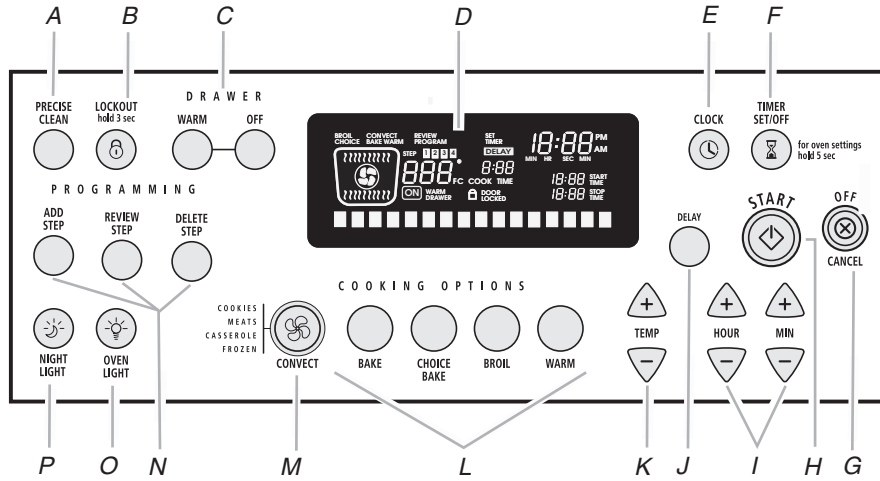

- A. Precise clean
- B. Control lockout
- C. Warming drawer (on some models)
- D. Oven display
- E. Clock
- F. Timer set/off
- G. Off/cancel
- H. Start
- I. Hour/minute
- J. Delay
- K. Temperature
- L. Oven settings
- M. Convection
- N. Programming options
- O. Oven light
- P. Night light

## Style 2 - Electronic Oven Control (on some models)

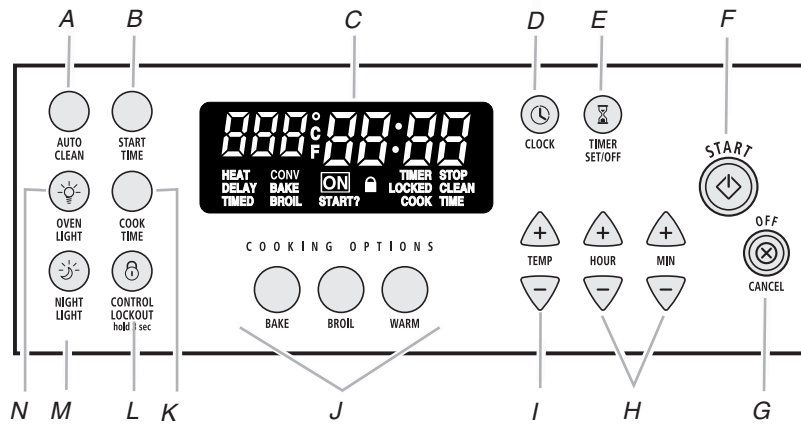

- A. Auto clean
- B. Control lockout
- C. Oven display
- D. Clock
- E. Timer set/off
- F. Start
- G. Off/cancel
- H. Hour/minute
- I. Temperature
- J. Oven settings
- K. Stop time
- L. Cook time
- M. Oven light
- N. Night light

**Style 3 - Electronic Oven Controls (on some models)**

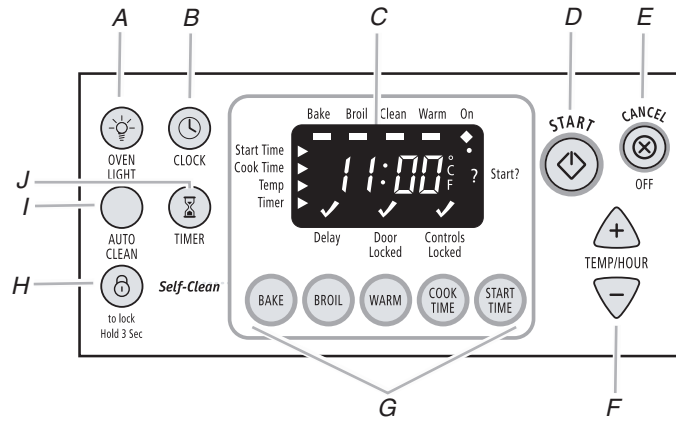

- A. Oven light (Convect on some models)
- B. Clock
- C. Oven display
- D. Start
- E. Cancel/off
- F. Temperature/time
- G. Oven settings
- H. Control lockout
- I. Auto clean (on some models)
- J. Timer

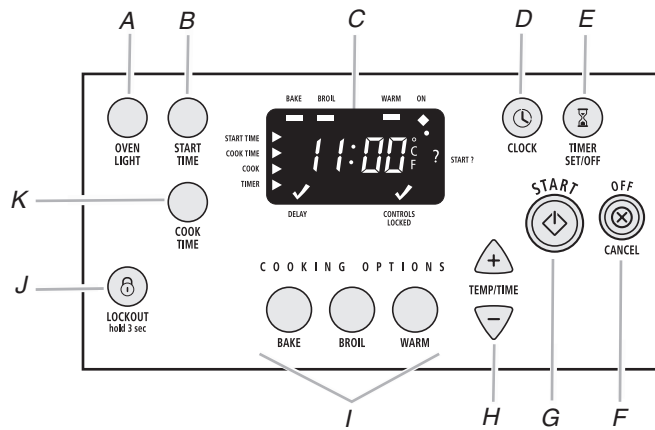

- A. Oven light
- B. Start time
- C. Oven display
- D. Clock
- E. Timer set/off
- F. Off/cancel
- G. Start
- H. Temperature/time
- I. Oven settings
- J. Control lockout
- K. Cook time

## Style 4 - Electronic Oven Control (on some models)

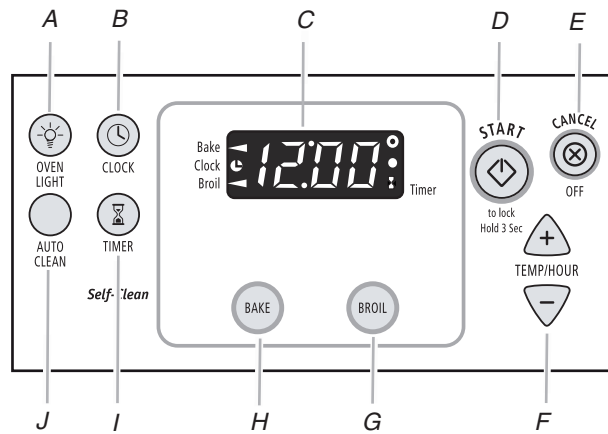

A. Oven light  
B. Clock  
C. Oven display  
D. Start/control lock  
E. Cancel/off

F. Temperature/time  
G. Broil  
H. Bake  
I. Timer  
J. Auto Clean

## Display

### Style 1 - Electronic Oven Control

When power is first supplied to the appliance, a flashing time will appear on the display. See "Clock" section to set time of day.

If a flashing time appears at any other time, a power failure has occurred. Press OFF/CANCEL and reset the clock if needed.

When the oven is not in use, the display shows the time of day.

### Styles 2, 3 & 4 - Electronic Oven Controls

When power is first supplied to the appliance, a flashing time will appear on the display. Press OFF/CANCEL to clear the display.

If a flashing time appears at any other time, a power failure has occurred. Press OFF/CANCEL and reset the clock if needed.

When the oven is not in use, the display shows the time of day.

When performing a timed cook function, the display will show either hours and minutes, or minutes and seconds.

## Start

### Style 1 - Electronic Oven Control

The Start pad begins any oven function. "SET TEMP OR TIME OR PUSH START" will appear on the display.

### Styles 2, 3 & 4 - Electronic Oven Controls

The Start pad begins any oven function, except kitchen timer. If the Start pad is not pressed within 5 seconds after pressing a function pad, the "START?" or "PUSH?" indicator light will appear on the display (on some models).

If the Start pad is not pressed within 5 minutes after pressing a function pad, the oven display will return to the time of day mode and the programmed function will be canceled.

## Off/Cancel

The Off/Cancel pad stops any function except the Clock, Timer, Control Lock or Warm Drawer (on some models).

## Clock

On some models, this is a 12-hour clock that shows a.m. and p.m.

### To Set:

Before setting, make sure the oven and Timer are off.

1. Press CLOCK.
2. Depending on your model, press the HOUR or MIN, TEMP/TIME or TEMP/HOUR "up" or "down" arrow pads to set the time of day, including a.m. or p.m.
3. Press CLOCK or START.

On some models, clock display can be turned off or on by pushing and holding CLOCK.

## Range Lights

### Oven Light

While the oven door is closed, press OVEN LIGHT to turn the light on and off. The oven light will come on when the oven door is opened. The oven light will not come on during the Self-Clean cycle.

### Night Light (on some models)

Press NIGHT LIGHT to turn the light on and off.

---

## Tones

Tones are audible signals, indicating the following:

### Basic Functions

#### One tone

- Valid pad press
- Oven is preheating (long tone)
- Function has been entered
- Reminder (on some models), repeating each minute after the end-of-cycle tones

#### Three tones

- Invalid pad press

#### Four tones

- End of cycle

---

### Style 1 - Electronic Oven Control

---

**Reminder Tones:** The audible tones at the end of a cycle may be set to beep once or continue to beep once per minute. Press and hold BAKE for 5 seconds to cycle on and off. "Repeating Alarm Off" or "Repeating Alarm On" will be displayed in the scrolling text.

**Sound:** All audible tones can be turned off. Reminder tones are still active when all sounds are disabled. Press and hold CLOCK for 5 seconds to cycle on and off. "All Sounds Off" or "All Sounds On" will be displayed in the scrolling text.

**Tone Pitch:** The tone pitch can be set to "Low" or "High." Press and hold BROIL for 5 seconds to cycle on and off. "Low" or "High" will be displayed in the scrolling text.

**End of Cycle Tones:** The End of Cycle Tone can be turned on or off. Press and hold BROIL for 5 seconds to cycle on and off. "On" or "Off" will be displayed in the scrolling text.

**Key Press Tone:** This feature disables or enables the tone that accompanies a valid key press. Press and hold "WARM" for 5 seconds to cycle on and off. "Key Press Tone On" or "Key Press Tone Off" will be displayed in the scrolling text.

---

### Style 2 - Electronic Oven Control

---

**Reminder Tones:** The audible tones at the end of a cook time or timer may be set to beep once for "Off" or continue to beep once per minute for "rEP On." Press and hold TIMER SET/OFF for 5 seconds to cycle on and off. "Off" or "rEP On" will momentarily appear on the display.

**Sound:** All audible tones can be turned off. Press and hold COOK TIME for 5 seconds to cycle on and off. "Off" or "Snd On" will momentarily appear on the display.

**Volume:** The tone volume can be set to "Lo" or "Hi." Press and hold START TIME for 5 seconds to cycle on and off. "Lo" or "Snd HI" will be momentarily appear on the display.

---

### Styles 3 & 4 - Electronic Oven Controls

---

**Reminder Tones:** The audible tones at the end of the Timer may be set to beep once or continue to beep. Press and hold TIMER for 5 seconds to enter Options mode. "Opt" will appear on the display. Use TEMP/HOUR to cycle through the options until you reach "b" or "b1" (depending on your model). Cycle on and off using TIMER. Press CANCEL to exit the mode.

---

## Fahrenheit and Celsius

The temperature is preset at Fahrenheit, but can be changed to Celsius.

---

### Style 1 - Electronic Oven Control

---

**To change:** Press and hold PRECISE CLEAN for 5 seconds, and "TEMPERATURE UNIT CELSIUS" will appear in the display. Repeat to change back to Fahrenheit.

To exit mode, press OFF/CANCEL.

---

### Styles 2, 3 & 4 - Electronic Oven Controls

---

**To change:** Press and hold BROIL for 5 seconds. A tone will sound and "°C" or "°F" will appear on the display. Repeat to change back to Fahrenheit.

To exit mode, press OFF/CANCEL.

---

## Timer

The Timer can be set in hours or minutes up to 12 hours and 59 minutes, and counts down the set time. The Timer does not start or stop the oven.

### To Set:

1. Press TIMER SET/OFF or TIMER. The timer indicator light will light up on some models. If no action is taken after 5 minutes, the display will return to the time of day.
2. Depending on your model, press the HOUR or MIN, TEMP/TIME or TEMP/HOUR "up" or "down" arrow pads to set the length of time.
3. Press TIMER SET/OFF or TIMER. When the set time ends, end-of-cycle tones will sound; then, if enabled, reminder tones will sound every minute on some models.
4. Press TIMER SET/OFF or TIMER twice to cancel the Timer and reminder tones.

**NOTE:** Do not press the OFF/CANCEL pad because the oven will turn off.

On some models, to display the time of day for 5 seconds when the timer is counting down, press CLOCK.

---

## Oven Control Lockout

(on some models)

The Control Lock, Control Lockout or Lockout button (depending on your model) shuts down the control panel pads to avoid unintended use of the oven.



When the control is locked, only the CLOCK SET, OVEN LIGHT (on some models) and TIMER pads will function.

**To Lock/Unlock Control:** Before locking, make sure the oven and Cook Timer are off. Press and hold "Control Lockout" key for 5 seconds. A single tone will sound, and "Loc" or "Lockout" will appear on the display.

Repeat to unlock. "Loc" or "Lockout" will disappear from the display.

## 12-Hour Shut-Off

### Styles 1, 2, 3 & 4 - Electronic Oven Controls

The oven control is set to automatically shut off the oven 12 hours after the oven turns on. This will not interfere with any timed or delayed cook function.

#### Style 1 - Electronic Oven Control

The 12-hour shutoff feature may be turned off on Style 1 electronic oven controls.

**To Set:** Press and hold DELAY for 5 seconds. 12 HR SHUT-OFF ON will appear on the display. Press and hold DELAY again for 5 seconds to turn off.

## Oven Temperature Control

**IMPORTANT:** Do not use a thermometer to measure oven temperature because opening the oven door may cause burner cycling to give incorrect readings.

The oven provides accurate temperatures; however, it may cook faster or slower than your previous oven, so the temperature calibration can be adjusted. It can be changed in Fahrenheit or Celsius.

A minus sign means the oven will be cooler by the displayed amount. The absence of a minus sign means the oven will be warmer by the displayed amount. Use the following chart as a guide.

ADJUSTMENT °F (ADJUSTMENT °C)	COOKS FOOD
10°F (5°C)	...a little more
20°F (10°C)	...moderately more
30°F (15°C)	...much more
-10°F (-5°C)	...a little less
-20°F (-10°C)	...moderately less
-30°F (-15°C)	...much less

### To Adjust Oven Temperature Calibration:

#### Style 1 - Electronic Oven Control

1. Press and hold OVEN LIGHT for 3 seconds until the oven display shows the current calibration. For example, "°F" will appear on the display.
2. Press the TEMP "up" or "down" arrow pad(s) to increase or to decrease the temperature in 10°F (5°C) amounts. The adjustment can be set between 30°F (15°C) and -30°F (-15°C).
3. Press START.

#### Styles 2, 3 & 4 - Electronic Oven Controls

1. Press and hold BAKE for 3 seconds until the oven display shows the current calibration, for example "0°F CAL" or "00."
2. Press the TEMP, TEMP/TIME or TEMP/HOUR "up" or "down" arrow pad(s) to increase or to decrease the temperature in 10°F (5°C) amounts. The adjustment can be set between 30°F (15°C) and -30°F (-15°C).
3. Press START.

## OVEN USE

Odors and smoke are normal when the oven is used the first few times, or when it is heavily soiled.

**IMPORTANT:** The health of some birds is extremely sensitive to the fumes given off. Exposure to the fumes may result in death to certain birds. Always move birds to another closed and well-ventilated room.

## Aluminum Foil

**IMPORTANT:** To avoid permanent damage to the oven bottom finish, do not line the oven bottom with any type of foil, liners or cookware.

- Do not cover entire rack with foil because air must be able to move freely for best cooking results.
- To catch spills, place foil on rack below dish. Make sure foil is at least ½" (1.3 cm) larger than the dish and that it is turned up at the edges.

## Positioning Racks and Bakeware

**IMPORTANT:** To avoid permanent damage to the porcelain finish, do not place food or bakeware directly on the oven door or bottom.

### RACKS

#### NOTES:

- Position racks before turning on the oven.
- Do not position racks with bakeware on them.
- Make sure racks are level.

To move a rack, pull it out to the stop position, raise the front edge, and then lift out. Use the following illustration and charts as a guide.

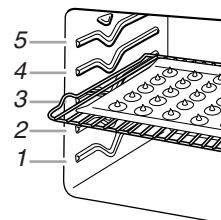

### Traditional Cooking

FOOD	RACK POSITION
Large roasts, turkeys, angel food, bundt and tube cakes, quick breads, pies	1 or 2
Yeast breads, casseroles, meat and poultry	2
Cookies, biscuits, muffins, cakes	2 or 3

### Convection Cooking

FUNCTION	NUMBER OF RACKS USED	RACK POSITION(S)
Convection baking or roasting	1	1, 2 or 3
Convection baking	2	2 and 4
Convection baking	3	1, 3 and 5

## BAKEWARE

To cook food evenly, hot air must be able to circulate. Allow 2" (5 cm) of space around bakeware and oven walls. Use the following chart as a guide.

NUMBER OF PAN(S)	POSITION ON RACK
1	Center of rack.
2	Side by side or slightly staggered.
3 or 4	Opposite corners on each rack. Make sure that no bakeware piece is directly over another.

## Split Oven Rack (on some models)

### Split-Rack with Removable Insert

The split-rack with removable insert is a space maximizer. When the two are attached, they make a full rack. The insert can also be removed to provide room for large items such as a turkey and casseroles. Do not place more than 25 lbs (11.3 kg) on the split-rack.

The insert can also be used on the counter for a cooling rack.

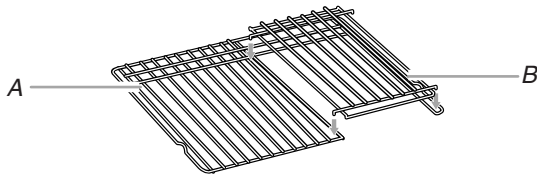

A. Split-rack  
B. Removable insert

If you would like to purchase a split-oven rack, one may be ordered. See "Assistance or Service" section to order. Ask for Part Number 4396927.

### To Use Racks:

1. Place a full rack on position 1 or 2, and the split-rack on position 3 or 4.
2. Place large items on the right side of the full rack.
3. Place deeper, covered dishes on the left side of the full rack.
4. Place shallow dishes on the split-rack.
5. When finished cooking, slowly remove items.

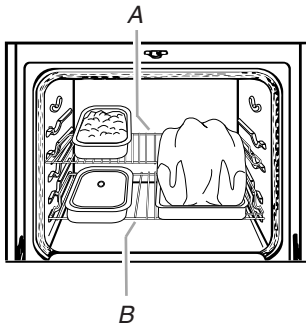

A. Rear rack section  
B. Front rack section

## Bakeware

The bakeware material affects cooking results. Follow manufacturer's recommendations and use the bakeware size recommended in the recipe. Use the following chart as a guide.

BAKEWARE/ RESULTS	RECOMMENDATIONS
<b>Light colored aluminum</b> <ul style="list-style-type: none"> <li>■ Light golden crusts</li> <li>■ Even browning</li> </ul>	<ul style="list-style-type: none"> <li>■ Use temperature and time recommended in recipe.</li> </ul>
<b>Dark aluminum and other bakeware with dark, dull and/or nonstick finish</b> <ul style="list-style-type: none"> <li>■ Brown, crisp crusts</li> </ul>	<ul style="list-style-type: none"> <li>■ May need to reduce baking temperatures 25°F (15°C).</li> <li>■ Use suggested baking time.</li> <li>■ For pies, breads and casseroles, use temperature recommended in recipe.</li> <li>■ Place rack in center of oven.</li> </ul>
<b>Insulated cookie sheets or baking pans</b> <ul style="list-style-type: none"> <li>■ Little or no bottom browning</li> </ul>	<ul style="list-style-type: none"> <li>■ Place in the bottom third of oven.</li> <li>■ May need to increase baking time.</li> </ul>
<b>Stainless steel</b> <ul style="list-style-type: none"> <li>■ Light, golden crusts</li> <li>■ Uneven browning</li> </ul>	<ul style="list-style-type: none"> <li>■ May need to increase baking time.</li> </ul>
<b>Stoneware/Baking stone</b> <ul style="list-style-type: none"> <li>■ Crisp crusts</li> </ul>	<ul style="list-style-type: none"> <li>■ Follow manufacturer's instructions.</li> </ul>
<b>Ovenproof glassware, ceramic glass or ceramic</b> <ul style="list-style-type: none"> <li>■ Brown, crisp crusts</li> </ul>	<ul style="list-style-type: none"> <li>■ May need to reduce baking temperatures 25°F (15°C).</li> </ul>

## Meat Thermometer

On models without a temperature probe, use a meat thermometer to determine doneness of meat, poultry and fish. The internal temperature, not appearance, should be used to determine doneness. A meat thermometer is not supplied with this appliance.

- Insert the thermometer into the center of the thickest portion of the meat or inner thigh or breast of poultry. The tip of the thermometer should not touch fat, bone or gristle.
- After reading the thermometer once, push it into the meat ½" (1.3 cm) more and read again. If the temperature drops, cook the meat or poultry longer.
- Check all meat, poultry and fish in 2 or 3 different places.

## Oven Vent

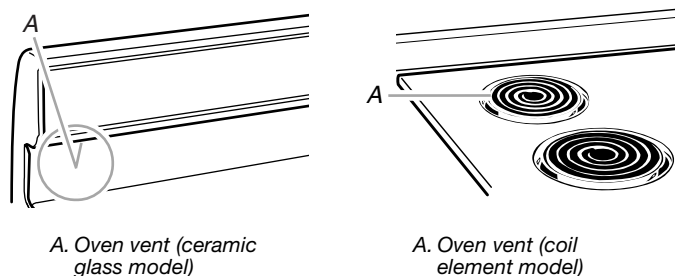

The oven vent releases hot air and moisture from the oven, and should not be blocked or covered. Blocking or covering the vent will cause poor air circulation, affecting cooking and cleaning results. Do not set plastics, paper or other items that could melt or burn near the oven vent.

On coil element models, the element can be used when the oven is in use as long as the cookware does not extend more than 1/2" (1.3 cm) over the element.

## Baking and Roasting

### ACCUBAKE® Temperature Management System

(on some models)

The ACCUBAKE® system electronically regulates the oven heat levels during preheat and bake to maintain a precise temperature range for optimal cooking results. The bake and broil elements cycle on and off in intervals. The bake element will glow red when cycling on, the broil element will not. This feature is automatically activated when the oven is in use.

Before baking and roasting, position racks according to the "Positioning Racks and Bakeware" section. When roasting, it is not necessary to wait for the oven preheat conditioning time to end before putting food in unless it is recommended in the recipe.

#### To Bake or Roast:

1. Press **BAKE**.  
Press **TEMP**, **TEMP/TIME** or **TEMP/HOUR** "up" or "down" arrow pads to set a temperature other than 350°F (175°C) in 5° amounts. The bake range can be set between 170°F and 500°F (75°C and 260°C).
2. Press **START**.  
The temperature can be changed after this step. **START** does not need to be pressed again on styles 2 and 3 of Electronic Oven Controls.
3. Press **OFF/CANCEL** when finished.

## Preheating

### Style 1 - Electronic Oven Control

After **START** is pressed, the oven will enter a timed preheat conditioning. "Lo" will appear on the display until the temperature is above 170°F (75°C). Once 170°F (75°C) is reached, the display temperature will increase in 2° increments as the actual temperature of the oven increases. "OVEN IS PREHEATING" will appear in the display in the lower text line. When the preheat conditioning temperature is reached, a tone will sound, and the selected temperature will appear on the display.

### Styles 2, 3 & 4 - Electronic Oven Controls

After **START** is pressed, the oven will enter a timed preheat conditioning. On some models, "PrE" will appear on the display. On some models, the time countdown will appear on the display. On some models, both "PrE" and the time countdown will appear on the display. When the preheat conditioning time ends, a tone will sound and the selected temperature will appear on the display.

Preheat temperatures are affected by varying factors such as room temperature and peak energy usage times. It is normal for the temperature showing on the display and the actual oven temperature to differ.

Waiting an additional 10 minutes after the preheat conditioning time ends to put food in the oven is suggested when baking foods with leavening ingredients, such as yeast, baking powder, baking soda and eggs.

## Choice Bake® Function

(on some models)

The CHOICE BAKE® function reduces top heat in the oven during cooking. It is ideal when baking pies, breads and casseroles and when roasting meat and poultry.

During traditional baking and roasting, the bake and broil elements or burners cycle on and off at intervals. When CHOICE BAKE® is selected, the broil element or burner cycles on less frequently. This reduces top browning of foods and allows you more customized control of your cooking results.

#### To Use:

1. Press **CHOICE BAKE®** function.  
Press the **TEMP** "up" or "down" arrow pads to set a temperature other than 350°F (175°C) in 5° increments. The bake range can be set between 170°F and 500°F (75°C and 260°C).
2. Press **START**.  
The temperature can be changed after this step by pressing the **TEMP** "up" or "down" arrow pads and then pressing **START**.
3. Press **OFF/CANCEL** when finished cooking.  
To use the CHOICE BAKE® function during a regular Bake cycle to achieve less top browning, press CHOICE BAKE® cycle, set the desired temperature and press **START**.

## Broiling

Broiling uses direct radiant heat to cook food. Changing the temperature when Custom Broiling allows more precise control when cooking. The lower the temperature, the slower the cooking. Thicker cuts and unevenly shaped pieces of meat, fish and poultry may cook better at lower broiling temperatures.

- For best results, use a broiler pan and grid (provided on some models). It is designed to drain juices and help avoid spatter and smoke.

If you would like to purchase a broiler pan, one may be ordered. See “Assistance or Service” section to order. Ask for Part Number 4396923.

- For proper draining, do not cover the grid with foil. The bottom of the pan may be lined with aluminum foil for easier cleaning.
- Trim excess fat to reduce spattering. Slit the remaining fat on the edges to avoid curling.
- Pull out oven rack to stop position before turning or removing food. Use tongs to turn food to avoid the loss of juices. Very thin cuts of fish, poultry or meat may not need to be turned.
- After broiling, remove the pan from the oven when removing the food. Drippings will bake on the pan if left in the heated oven, making cleaning more difficult.

Before broiling, position rack according to the Broiling Chart. It is not necessary to preheat the oven before putting food in unless recommended in the recipe. Position food on grid in the broiler pan, then place it in the center of the oven rack. Close the door to the broil stop position to ensure proper broiling temperature.

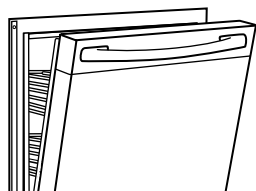

### To Broil:

1. Open door to broil stop position.
2. Press BROIL.
3. Press START.
4. Press OFF/CANCEL when finished.

### To Custom Broil (on some models):

1. Press BROIL.
2. Press TEMP or TEMP/HOUR “up” or “down” arrow pads to change the temperature in 5°F (5°C) amounts. The broil range can be set between 300°F and 525°F (150°C and 275°C).
3. Press START.
4. Press OFF/CANCEL when finished.

### BROILING CHART

For best results, place food 3" (7 cm) or more from the broil element. Times are guidelines only and may need to be adjusted for individual tastes. Recommended rack positions are numbered from the bottom (1) to the top (5). For diagram, see the “Positioning Racks and Bakeware” section.

FOOD	RACK POSITION	COOK TIME minutes	
		Side 1	Side 2
<b>Steak</b>			
1" (2.5 cm) thick			
medium rare	4	14-15	7-8
medium	4	15-16	8-9
well-done	4	18-19	9-10
<b>Ground meat patties*</b>			
¾" (2 cm) thick			
well-done	4	13-14	7-8
<b>Pork chops</b>			
1" (2.5 cm) thick	4	20-22	10-11
<b>Ham slice, precooked</b>			
½" (1.25 cm) thick	4	8-10	4-5
<b>Frankfurters</b>			
	4	5-7	3-4
<b>Lamb chops</b>			
1" (2.5 cm) thick	4	14-17	8-9
<b>Chicken</b>			
bone-in pieces	3	17-20	17-20
boneless breasts	4	11-16	11-16
<b>Fish Fillets ¼-½"</b> (0.6-1.25 cm) thick			
	4	8-10	4-5
<b>Fish Steaks ¾-1"</b> (2-2.5 cm) thick			
	4	16-18	8-9

\*Place up to 9 patties, equally spaced, on broiler pan grid.

## Convection Cooking

(Styles 1 & 3 - Electronic Oven Control)

During convection cooking, the fan provides increased hot air circulation continuously and more consistently throughout the oven. The movement of heated air around the food helps to speed up cooking by penetrating the cooler outer surfaces. Food cooks more evenly, browning and crisping outer surfaces while sealing moisture inside.

Many foods can be cooked by lowering cooking temperatures 25°F (10°C) and/or cooking time can be shortened by as much as 30 percent. By using multiple racks, you can cook more food at the same time.

- It is important not to cover foods so that surface areas remain exposed to the circulating air, allowing browning and crisping.
- Keep heat loss to a minimum by only opening the oven door when necessary.
- Choose cookie sheets without sides and roasting pans with lower sides to allow air to move freely around the food.
- Test baked goods for doneness a few minutes before the minimum cooking time with an alternative method such as using a toothpick.
- Use a meat thermometer to determine the doneness of meats and poultry. Check the temperature of pork and poultry in 2 or 3 different places.
- Before convection cooking, position the rack(s) according to the “Positioning Racks and Bakeware” section.

- When roasting poultry and meat, use the roasting rack on the top of the broiler pan and grid. It is not necessary to wait for the oven to preheat, unless recommended in the recipe.

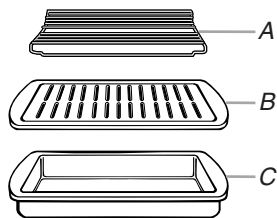

A. Roasting rack  
B. Broiler grid  
C. Broiler pan

### Style 1 - Convection Baking and Roasting

During the CONVECT function, the ring element operates, along with the fan, to provide an indirect source of heat in the oven cavity. Use CONVECT for single or multiple rack baking and roasting.

- When using more than one rack, position bakeware/cookware on the racks to allow movement of the fan circulated air around the food. See the “Positioning Racks and Bakeware” section.

- If the oven is full, extra cooking time may be needed.

During the CONVECT preheating cycle, the fan, and the bake and broil elements heat the oven cavity. When preheating is finished, the ring element cycles to maintain the oven temperature while the fan continues to constantly circulate the heated air.

If the oven door is opened during convection cooking or preheating, the element(s) and fan will turn off immediately. Once the door is closed, they will come back on.

- For optimal cooking results, do not cover food with aluminum foil.

#### To Select Convection Settings

There are 5 convection presets for time and temperature. Each can be activated by sequentially pressing the CONVECT key.

The temperatures and times can be changed for each of the following settings. This helps you to match the convection oven settings with package instructions or your favorite recipes.

#### Convection Settings

Function	Temperature	Time (default)
CONVECT (default)	325°F (163°C)	0 minutes
CONVECT COOKIES	350°F (177°C)	0 minutes
CONVECT MEATS	325°F (163°C)	1 hour 30 minutes
CONVECT CASSEROLES	325°F (163°C)	45 minutes
CONVECT FROZEN	425°F (218°C)	25 minutes

**NOTE:** Each temperature in this table is 25°F (10° to 15°C) lower than for a non-convection oven. At the end of each set time, the oven will turn off.

- Press CONVECT keypad.

The first setting in the display will show convection at 325°F (165°C), and scrolling text at the bottom of the screen will scroll in this order: “SET TEMP OR TIME” then “OR PUSH START” then “PUSH AGAIN” then “FOR NEXT.”

Each time the CONVECT keypad is pressed, the display will move to the next preset (for Cookies, Meats, Casseroles or Frozen). The following instructions are applicable for each preset.

- Press the TEMP “up” or “down” arrow pads to enter a temperature other than the preset convection temperature. The convection bake range can be set between 170°F and 500°F (75°C and 260°C).
- Press the HOUR and/or MIN “up” or “down” arrow pads to enter the stop time.
- Press START.

The preheat display will show “Lo” in the temperature field until the temperature is above 170°F (75°C). Once 170°F (75°C) is reached, the display temperature will increase as the actual temperature of the oven increases, and it will display “OVEN IS PREHEATING” in the lower text line.

- Press OFF/CANCEL to exit function when finished cooking.

### Style 3 - Convection Baking and Roasting (on some models)

The convection feature is ideal for single rack baking and roasting. If using more than one rack, move pans from top to bottom shelf halfway through cooking.

During convection baking or roasting, the bake and broil elements cycle on and off in intervals to maintain the oven temperature, while the fan circulates the hot air.

If the oven door is opened during convection baking or roasting, the fan will turn off immediately. It will come back on when the oven door is closed.

#### To Use:

- Press BAKE or BROIL.
- Press CONVECT keypad to turn on fan.
- Press the TEMP/HOUR (or TEMP/TIME) “up” or “down” arrow pads to desired temperature.
- Press START.
- Press CONVECT keypad to turn off fan when finished cooking.
- Press OFF/CANCEL to turn off oven.

## CONVECTION ROASTING CHART

FOOD/ RACK POSITION	COOK TIME (min. per 1 lb [454 g])	OVEN TEMP.	INTERNAL FOOD TEMP.
<b>Beef, Rack Position 2</b>			
<b>Rib Roast</b>			
rare	20-25		140°F (60°C)
medium	25-30	300°F (149°C)	160°F (71°C)
well-done	30-35		170°F (77°C)
<b>Rib Roast (boneless)</b>			
rare	22-25		140°F (60°C)
medium	27-30	300°F (149°C)	160°F (71°C)
well-done	32-35		170°F (77°C)
<b>Rump, Sirloin Tip Roast</b>			
rare	20-25		140°F (60°C)
medium	25-30	300°F (149°C)	160°F (71°C)
well-done	30-35		170°F (77°C)
<b>Meat Loaf</b>	20-25	325°F (163°C)	165°F (74°C)
<b>Veal, Rack Position 2</b>			
<b>Loin, Rib, Rump Roast</b>			
medium	25-35	325°F (163°C)	160°F (71°C)
well-done	30-40		170°F (77°C)
<b>Pork, Rack Position 2</b>			
<b>Loin Roast (boneless)</b>	30-40	325°F (163°C)	160°F-170°F (71°C-77°C)
<b>Shoulder Roast</b>	35-40	325°F (163°C)	160°F-170°F (71°C-77°C)
<b>Ham, Rack Position 2</b>			
<b>Fresh (uncooked)</b>	25-35	300°F (149°C)	160°F (71°C)
<b>Fully Cooked</b>	15-20	300°F (149°C)	160°F (71°C)
<b>Lamb, Rack Position 2</b>			
<b>Leg, Shoulder Roast</b>			
medium	25-30	300°F (149°C)	160°F (71°C)
well-done	30-35		170°F (77°C)
<b>Chicken*, Rack Position 2</b>			
<b>Whole</b>			
3-5 lbs (1.5-2.2 kg)	20-25	325°F (163°C)	180°F (82°C)
5-7 lbs (2.2-3.1 kg)	15-20	325°F (163°C)	180°F (82°C)

FOOD/ RACK POSITION	COOK TIME (min. per 1 lb [454 g])	OVEN TEMP.	INTERNAL FOOD TEMP.
<b>Turkey*, Rack Positions 1 or 2</b>			
13 lbs and under (5.85 kg)	10-15	300°F (149°C)	180°F (82°C)
Over 13 lbs (5.85 kg)	10-12	300°F (149°C)	180°F (82°C)
<b>Cornish Game Hens*, Rack Position 2 or 3</b>			
1-1.5 lbs (0.5-0.7 kg)	50-60	325°F (163°C)	180°F (82°C)

\*Do not stuff poultry when convection roasting.

### Hold Warm Feature (on some models)

## WARNING

### Food Poisoning Hazard

Do not let food sit in oven more than one hour before or after cooking.

Doing so can result in food poisoning or sickness.

**IMPORTANT:** Food must be at serving temperature before placing it in the warmed oven. Food may be held up to 1 hour; however, breads and casseroles may become too dry if left in the oven during Hold Warm.

The Hold Warm feature allows hot cooked foods to stay at serving temperature. It can also be used at the end of a timed cook.

### Style 1 - Electronic Oven Control

#### To Use:

1. Press WARM.
2. Temperature is preset at 170° (75°C) for 60 minutes.  
Press the TEMP “up” or “down” arrow pad to raise or lower the temperature in 5°F (5°C) amounts to set a temperature other than 170°F (75°C). The warm range is 170°F-200°F (75°C-93°C).
3. Press START.
4. Press OFF/CANCEL when finished.

---

## Style 2 - Electronic Oven Control

---

### To Use:

1. Press WARM.
2. Set the temperature (optional).  
Press the TEMP “up” or “down” arrow pad to raise or lower the temperature in 5°F (5°C) amounts to set a temperature other than 170°F (75°C). The warm range is 170°F-200°F (75°C-93°C).
3. Press START.
4. Press OFF/CANCEL when finished.

### To Add to the End of a Set Cook Time:

1. Press BAKE.
2. Set the temperature (optional).  
Press the TEMP “up” or “down” arrow pad to set a temperature other than 350°F (177°C).
3. Press COOK TIME.
4. Press the HOUR/MIN “up” or “down” arrow pads to set cook time.
5. Press WARM.  
A 1 hour warm time will automatically be set.
6. Set the warm temperature (optional).  
Press the TEMP “up” or “down” arrow pad to raise or lower the temperature in 5°F (5°C) amounts to set a temperature other than 170°F (75°C). The warm range is 170°F-200°F (75°C-93°C).
7. Press START.  
The display will show the cook time counting down. When cook time ends, the display will show a warming time.  
  
When warming time ends, the oven will automatically shut off and “End” and COOK TIME will show on the display. Four tones will sound, and then four 1-second reminder tones will sound every minute thereafter.
8. Press OFF/CANCEL or open the oven door to stop reminder tones and remove “End” from display. The time of day will return to the display.

---

## Style 3 - Electronic Oven Control

---

### To Use:

1. Press WARM.
2. Temperature is set at 170° (75°C) for 60 minutes.
3. Press START.
4. Press OFF/CANCEL when finished.

---

## Timed Cooking

(on some models)

# WARNING

### Food Poisoning Hazard

**Do not let food sit in oven more than one hour before or after cooking.**

**Doing so can result in food poisoning or sickness.**

Timed Cooking allows the oven to be set to turn on at a certain time of day, cook for a set length of time, and/or shut off automatically. Delay start should not be used for food such as breads and cakes because they may not bake properly.

---

## Style 1 - Electronic Oven Control

---

### To Set a Timed Cook:

1. Press the desired cook function. The indicator text will light up.
2. Set the temperature (optional).
3. Press the TEMP “up” or “down” arrow pad to enter a temperature other than the one displayed.
4. Press HOUR and/or MIN “up” or “down” arrow pad to enter the length of time to cook.
5. Press START. The display will count down the time. When the time ends, the oven will shut off automatically.
6. Press OFF/CANCEL to clear the display.

### To Set a Delayed Timed Cook:

Before setting, make sure the clock is set to the correct time of day. See “Clock” section.

1. Press desired cook function.
2. Set the temperature (optional).
3. Press the TEMP “up” or “down” arrow pad to enter a temperature other than the one displayed.
4. Press the HOUR and/or MIN “up” or “down” arrow pad to enter the length of time to cook.
5. Press DELAY. SET STOP TIME will light up.
6. Press the HOUR and/or MIN “up” or “down” arrow pad to enter the time of day to stop.
7. Press START.

When the start time is reached, the oven will automatically turn on. The temperature and/or time settings can be changed anytime after pressing START by repeating steps 1-6 and following the display prompt. When the set cook time ends, the oven will shut off automatically.

8. Press OFF/CANCEL to clear the display.

---

## Style 2 - Electronic Oven Control

---

### To Set a Timed Cook:

1. Press desired cook function (optional).
2. Press the TEMP “up” or “down” arrow pads to enter a temperature other than the one displayed.
3. Press COOK TIME.
4. Press the HR and MIN “up” or “down” arrow pads to enter the desired length of time to cook.
5. Press START. The display will count down the time.  
When the time ends, the oven will shut off automatically and “End” will appear on the display. End-of-cycle tones will sound; then, if enabled, reminder tones will sound every minute.
6. Open and close the oven door to clear the display and/or stop reminder tones.

### To Set a Delayed Timed Cook:

Before setting, make sure the clock is set to the correct time of day. See “Clock” section.

1. Press desired cook function.
2. Press the TEMP “up” or “down” arrow pads to enter a temperature other than the one displayed.
3. Press COOK TIME.
4. Press the HOUR and MIN “up” or “down” arrow pads to enter the length of time to cook.
5. Press START TIME.
6. If START TIME has been pressed, press the HR and MIN “up” or “down” arrow pads to enter the desired time to start cooking.
7. Press START. “DELAY” will appear on the display.  
When the start time is reached, the oven will automatically turn on. When the stop time is reached (if programmed), the oven will shut off automatically and “End” will appear on the display. End-of-cycle tones will sound; then, if on, reminder tones will sound every minute.
8. Open and close the oven door to clear the display and/or stop reminder tones.

---

## Style 3 - Electronic Oven Control

---

### To Set a Timed Cook:

1. Press BAKE. The bake indicator light will light up.
2. Press the TEMP/HOUR (or TEMP/TIME) “up” or “down” arrow pads to enter a temperature other than the one displayed.
3. Press COOK TIME. The cook time oven indicator light will light up.
4. Press the TEMP/HOUR (or TEMP/TIME) “up” or “down” arrow pad to enter the length of time to cook.
5. Press START. The display will count down the time. When the time ends, the oven will shut off automatically and “End” will appear on the display.
6. Press OFF/CANCEL to clear the display.

### To Set a Delayed Timed Cook:

Before setting, make sure the clock is set to the correct time of day. See “Clock” section.

1. Press BAKE.
2. Press the TEMP/HOUR (or TEMP/TIME) “up” or “down” arrow pad to enter a temperature other than the one displayed.
3. Press COOK TIME. The cook time oven indicator light will light up.
4. Press TEMP/HOUR (or TEMP/TIME) “up” or “down” arrow pad to enter the length of time to cook.
5. Press START TIME. The start time/delay oven indicator light will light up.
6. Press TEMP/HOUR (or TEMP/TIME) “up” or “down” arrow pad to enter the time of day to start.
7. Press START.  
When the start time is reached, the oven will automatically turn on. The temperature and/or time settings can be changed anytime after pressing Start by repeating steps 2-7. When the set cook time ends, the oven will shut off automatically and “End” will appear on the display.
8. Press OFF/CANCEL to clear the display.

---

## Sequence Programming (Style 1 - Electronic Oven Control)

Sequence Programming allows you to program up to 4 cooking functions at one time. Other oven functions, such as the Timer and Warming Drawer may be used when a sequenced program is running.

Sequence Programming takes precedence over any nonsequenced cook function. For example, if an untimed Bake function is in process and a sequence program is started, the untimed Bake function will be canceled, and the program sequence will start.

Sequence programming cannot be started until all currently running cooking functions have been canceled.

When you are using Sequence Programming, “STEPS 1 2 3 4” will appear on the oven display.

### To Program the First Step of the Sequence:

1. Choose a desired cook function by pressing any COOKING OPTION key. For example, press BAKE.  
“SET TEMP OR TIME OR PUSH START” will appear on the oven display.
2. Set a desired temperature (optional).  
“SET COOK TIME OR PUSH START” will appear on the oven display.  
If BAKE was pressed as your first step in the sequence, the default temperature will be 350°F (175°C). Press the TEMP “up” or “down” arrow pad to adjust the temperature.
3. To enter the first step of the sequence, enter a cook time by pressing the HOUR and/or MIN “up” or “down” keys.  
“PUSH START OR ADD STEP” will appear on the oven display.
4. Press ADD STEP.

**NOTE:** If START is pressed after only one sequence has been programmed, a regular cooking mode will start. For example, if you chose BAKE as your first step, and START is pressed, the oven will begin a normal baking cycle. After START has been pressed, additional steps cannot be added to the sequencing. If additional steps are desired, press OFF/CANCEL. This will exit the sequence program, and the oven display will return to just the time of day.

### To Program Steps 2, 3 and 4 of the Sequence:

1. Press ADD STEP.  
“SELECT COOK OPTION” will appear on the display.
2. Choose a desired cook function by pressing any cook function key. For example, BROIL.
3. Select a desired temperature (optional).
4. Set the cook time by pressing the HOUR and/or MIN pads.  
“PUSH START OR ADD STEP” will appear on the oven display.

If you choose to press START, your program sequence will begin. Additional steps cannot be added to the sequence once START has been pressed.

If you choose to add an additional step, press ADD STEP.  
“SELECT COOK OPTION” will appear on the oven display.

5. Continue repeating steps 1 through 4 until the maximum number of sequences have been set. You can program up to 4 cooking functions within the sequence.

### To Review/Modify Programmed Sequence:

If program steps are partially or completely programmed, yet the sequence has not been started, the programmed cook functions can be reviewed.

1. Press REVIEW STEP. “STEP 1” will appear in the display.  
Subsequent presses of REVIEW STEP will cause display of programmed steps in order.  
“STEP” and “REVIEW” will appear on the display. The number of the displayed step will be highlighted. A recalled step will remain lit on the display for 10 seconds if no further action is taken.
2. If fewer than 4 steps have been programmed, press REVIEW STEP if it is desired to program an additional step.
3. After Review/Modification of the programmed sequence is complete, press START to begin sequence.

### To Modify Sequence Programming:

1. Press DELETE STEP.  
The last step of the sequence will be canceled, then “STEP 1” will show on the display for either review or modification.  
If the programmed sequence has not been started, see “To Program Steps 2, 3 and 4 of the Sequence” section to program a step to replace the canceled cook function.
2. Press START. The first step will show on the display, and the program sequence will begin.  
Changes can be made during a programmed cook function; however, changes cannot be made after a programmed cook function has been completed.  
If at any time during an active sequenced program ADD STEP is pressed, 3 invalid tones will sound.

## Warming Drawer (on some models)

### **WARNING**

#### **Food Poisoning Hazard**

**Do not let food sit for more than one hour before or after cooking.**

**Doing so can result in food poisoning or sickness.**

The Warming Drawer is ideal for keeping hot cooked foods at serving temperature. It may also be used for warming breads and pastries.

Different types of food may be placed in the warming drawer at the same time. For best results, do not hold foods longer than 1 hour. For smaller quantities or heat-sensitive foods, such as eggs, do not hold longer than 30 minutes.

Food must be at serving temperature before being placed in the warming drawer. Breads, pastries, and fruit pies may be heated from room temperature.

Remove food from plastic bags and place in oven-safe container. Cover foods with a lid or aluminum foil.

Do not cover with plastic wrap.

Empty serving dishes and ovenproof dishes can be heated while the warming drawer is preheating.

Before using the warming drawer, wash the tray that lines the bottom of the drawer with soap and water. See “General Cleaning” section.

#### **To Use:**

1. Place cooked food(s) in warming drawer.
  2. Press DRAWER WARM.  
“WARM DRAWER” will appear on the display.
  3. Press START.  
“WARM DRAWER” will appear on the display.
  4. Press DRAWER OFF when finished.
- The Warming Drawer operates at 170°F (75°C) only.

# RANGE CARE

## Self-Cleaning Cycle (on some models)

### **⚠ WARNING**



#### **Burn Hazard**

**Do not touch the oven during the Self-Cleaning cycle.**

**Keep children away from oven during Self-Cleaning cycle.**

**Failure to follow these instructions can result in burns.**

**IMPORTANT:** The health of some birds is extremely sensitive to the fumes given off during the Self-Cleaning cycle. Exposure to the fumes may result in death to certain birds. Always move birds to another closed and well-ventilated room.

Self-clean the oven before it becomes heavily soiled. Heavy soil results in longer cleaning and more smoke.

Keep the kitchen well-ventilated during the Self-Cleaning cycle to help get rid of heat, odors, and smoke.

Do not block the oven vent(s) during the Self-Cleaning cycle. Air must be able to move freely. Depending on your model, see “Oven Vent” or “Oven Vents” section.

Do not clean, rub, damage or move the oven door gasket. The door gasket is essential for a good seal.

#### **Prepare Oven:**

- Remove the broiler pan, grid, cookware and bakeware and, on some models, the temperature probe from the oven.
- Remove any foil from the oven because it may burn or melt, damaging the oven.
- Remove oven racks to keep them shiny and easy to slide. See “General Cleaning” section for more information.
- Hand clean inside door edge and the 1½" (3.8 cm) area around the inside oven cavity frame, being certain not to move or bend the gasket. This area does not get hot enough during self-cleaning to remove soil. Do not let water, cleaner, etc. enter slots on door frame. Use a damp cloth to clean this area.
- Wipe out any loose soil to reduce smoke and avoid damage. At high temperatures, foods react with porcelain. Staining, etching, pitting or faint white spots can result. This will not affect cooking performance.

#### **Prepare Cooktop and Storage Drawer:**

- Remove plastic items from the cooktop because they may melt.
- Remove all items from the storage drawer.

#### **How the Cycle Works**

**IMPORTANT:** The heating and cooling of porcelain on steel in the oven may result in discoloring, loss of gloss, hairline cracks and popping sounds.

Before self-cleaning, make sure the door is completely closed or the door will not lock and the self-cleaning cycle will not begin.

Do not wipe down any of the inside surfaces until the oven has completely cooled down. Applying a cool damp cloth to the inner door glass before it has completely cooled could result in the glass breaking.

To stop the self-cleaning cycle at anytime, press OFF/CANCEL. If the temperature is too high the oven door will remain locked and “cool” and “locked” will be displayed.

The oven light will not function during the self-cleaning cycle.

#### **Style 1 - Electronic Oven Control (on some models)**

The PRECISECLEAN™ self-cleaning cycle is a “one touch” step that uses very high temperatures and dissolves soil to a powdery ash. The PRECISECLEAN™ setting will automatically determine the length of cleaning time needed based on the number of times the oven has been used since the last self-cleaning cycle. The maximum clean time is 4 hours 30 minutes, and the minimum clean time is 2 hours 30 minutes.

#### **To Self-Clean:**

1. Press PRECISECLEAN™.
2. Press START.

The oven door will automatically lock, and “DOOR LOCKED” will appear on the oven display. The start time, stop time, and clean time will be displayed in the oven control display.

3. After the self-clean cycle is complete and the oven cools, “DOOR LOCKED” will disappear from the oven control display. Press any pad on the control or open the oven door to clear the display.
4. When the oven is completely cooled, remove ash with a damp cloth.

#### **To Delay Start Self-Clean:**

1. Press PRECISECLEAN™.
2. Press DELAY.

3. Press the HOUR and MIN “+” or “-” arrow pads to enter the desired stop time. The start time, stop time, and clean time will be displayed in the oven control display.

4. Press START.

The oven door will automatically lock, and “DOOR LOCKED” will appear on the oven display. The start time, stop time, and clean time will be displayed in the oven control display.

5. After the self-clean cycle is complete and the oven cools, “DOOR LOCKED” will disappear from the oven control display. Press any pad on the control or open the oven door to clear the display.
6. When the oven is completely cooled, remove ash with a damp cloth.

---

### Style 2 - Electronic Oven Control (on some models)

---

The AUTO CLEAN self-cleaning cycle is time adjustable between 2 hours 30 minutes and 4 hours 30 minutes in 15-minute increments. Suggested clean times are 2 hours 30 minutes for light soil, and 4 hours 30 minutes for heavy soil. The last 30 minutes of the cycle is cool down.

#### To Self-Clean:

1. Press AUTO CLEAN.
2. Press the HOUR and MIN “+” or “-” arrow pads to enter the desired self-clean cycle time.
3. Press START.  
The oven door will automatically lock, and “CLN, LOCKED CLEAN” will appear on the oven display. The time remaining will also be displayed.
4. After the self-clean cycle is complete “END” will appear on the displayed. Press any pad on the control or open the oven door to clear the display.
5. When the oven is completely cooled, remove ash with a damp cloth.

#### To Delay Start Self-Clean:

1. Press AUTO CLEAN.
2. Press the HOUR and MIN “+” or “-” arrow pads to enter the desired self-clean cycle time.
3. Press START TIME.
4. Press the HOUR and MIN “+” or “-” arrow pads to enter the desired start time.
5. Press START.  
The oven door will automatically lock. The DELAY, LOCKED CLEAN, and ON indicator lights will be displayed.
6. After the self-clean cycle is complete “END” will appear on the displayed. Press any pad on the control or open the oven door to clear the display.
7. When the oven is completely cooled, remove ash with a damp cloth.

---

### Style 3 - Electronic Oven Control (on some models)

---

The AUTO CLEAN self-cleaning cycle is time adjustable between 2 hours 30 minutes and 4 hours 30 minutes in 15-minute increments. Suggested clean times are 2 hours 30 minutes for light soil, and 4 hours 30 minutes for heavy soil. The last 30 minutes of the cycle is cool down.

#### To Self-Clean:

1. Press AUTO CLEAN.
2. Press the TEMP/HOUR (or TEMP/TIME) “+” or “-” arrow pads to enter the desired self-clean cycle time.
3. Press START.  
The oven door will automatically lock. The DOOR LOCKED and CLEAN indicator lights will be displayed. The time remaining will also be displayed.
4. When the self clean cycle is complete and the oven cools, the DOOR LOCKED and CLEAN indicator lights will turn off.
5. When the oven is completely cooled, remove ash with a damp cloth.

#### To Delay Start Self-Clean:

1. Press AUTO CLEAN.
2. Press the TEMP/HOUR (or TEMP/TIME) “+” or “-” arrow pads to enter the desired self-clean cycle time.
3. Press START TIME.
4. Press the TEMP/HOUR (or TEMP/TIME) “+” or “-” arrow pads to enter the desired start time.
5. Press START.  
The oven door will automatically lock. The DOOR LOCKED and CLEAN indicator lights will be displayed.
6. When the self clean cycle is complete and the oven cools, the DOOR LOCKED and CLEAN indicator lights will turn off.
7. When the oven is completely cooled, remove ash with a damp cloth.

---

### Style 4 - Electronic Oven Control (on some models)

---

The self-cleaning cycle can be set at HI self-clean time (4 hours 30 minutes) or LO self-clean time (3 hours 30 minutes). The suggested clean times are 3 hours 30 minutes for light soil, or 4 hours 40 minutes for heavy soil. The last 30 minutes of the cycles is cool down.

#### To Self-Clean:

1. Press AUTO CLEAN to set the clean time to HI (4 hours 30 minutes). Press the TEMP/HOUR “+” or “-” arrow pads to cycle between LO and HI clean time
2. Press START.  
The oven door will automatically lock. The CLEAN indicator light will be displayed. The time remaining will also be displayed.
3. When the self clean cycle is complete and the oven cools, the CLEAN indicator light will turn off.
4. When the oven is completely cooled, remove ash with a damp cloth.

There is no Delay Start Self-Clean setting available on these models.

---

## General Cleaning

**IMPORTANT:** Before cleaning, make sure all controls are off and the oven and cooktop are cool. Always follow label instructions on cleaning products.

Soap, water and a soft cloth or sponge are suggested first unless otherwise noted.

---

### EXTERIOR PORCELAIN ENAMEL SURFACES (on some models)

---

Food spills containing acids, such as vinegar and tomato, should be cleaned as soon as the entire appliance is cool. These spills may affect the finish.

#### Cleaning Method:

- Glass cleaner, mild liquid cleaner or nonabrasive scrubbing pad:  
Gently clean around the model and serial number plate because scrubbing may remove numbers.
- All-Purpose Appliance Cleaner Part Number 31662 (not included):  
See “Assistance or Service” section to order.

---

## STAINLESS STEEL (on some models)

---

### Cleaning Method:

Rub in direction of grain to avoid damaging.

- Stainless Steel Cleaner & Polish Part Number 31462 (not included): See “Assistance or Service” section to order.
- Liquid detergent or all-purpose cleaner: Rinse with clean water and dry with soft, lint-free cloth.
- Vinegar for hard water spots

To avoid damage to stainless steel, do not use soap-filled scouring pads, abrasive cleaners, Cooktop Polishing Creme, steel-wool pads, gritty washcloths or some paper towels.

---

## CERAMIC GLASS (on some models)

---

### Cleaning Method:

Always wipe with a clean, wet cloth or sponge and dry thoroughly to avoid streaking and staining.

Cooktop Cleaner Part Number 31464 is recommended regularly to help avoid scratches, pitting and abrasions and to condition the cooktop, and can be ordered as an accessory. See “Assistance or Service” section to order.

Cooktop Scraper Part Number 3183488 is also recommended for stubborn soils, and can be ordered as an accessory. See “Assistance or Service” section to order. The Cooktop Scraper uses razor blades. **Store razor blades out of the reach of children.**

### Light to moderate soil

- Paper towels or clean damp sponge:  
Clean while the cooktop is still warm. You may want to wear oven mitts while cleaning the cooktop.

### Sugary spills (jellies, candy, syrup)

- Cooktop Scraper:  
Clean while the cooktop is still warm. You may want to wear oven mitts while cleaning the cooktop.
- Cooktop Polishing Creme and clean damp paper towel:  
Clean as soon as cooktop has cooled down. Rub creme into surface with a damp paper towel or soft cloth. Continue rubbing until white film disappears.

### Heavy soil, dark streaks, specks and discoloration

- Cooktop Polishing Creme or nonabrasive cleanser:  
Rub product into soil with a damp paper towel or soft cloth. Continue rubbing until white film disappears.

### Burned-on soil

- Cooktop Cleaner and Cooktop Scraper:  
Rub creme into soil with damp paper towel. Hold scraper as flat as possible on surface and scrape. Repeat for stubborn spots. Polish entire cooktop with creme and paper towel.

### Metal marks from aluminum and copper

- Cooktop Cleaner:  
Clean as soon as cooktop has cooled down. Rub creme into surface with a damp paper towel or soft cloth. Continue rubbing until white film disappears. The marks will not totally disappear, but after many cleanings they will become less noticeable.

## Tiny scratches and abrasions

- Cooktop Cleaner:  
Rub creme into surface with a damp paper towel or soft cloth. Continue rubbing until white film disappears. Scratches and abrasions do not affect cooking performance, and after many cleanings they will become less noticeable.

Do not use steel wool, abrasive powder cleansers, chlorine bleach, rust remover or ammonia because damage may occur.

---

## COOKTOP CONTROLS

---

### Cleaning Method:

When replacing knobs, make sure knobs are in the Off position.

On some models, do not remove seals under knobs.

- Soap and water or dishwasher:  
Pull knobs straight away from control panel to remove.

Do not use steel wool, abrasive cleansers or oven cleaner.

Do not soak knobs.

---

## CONTROL PANEL

---

### Cleaning Method:

- Glass cleaner and soft cloth or sponge: Apply glass cleaner to soft cloth or sponge, not directly on panel.
- All-Purpose Appliance Cleaner Part Number 31662 (not included):  
See “Assistance or Service” section to order.

Do not use abrasive cleaners, steel-wool pads, gritty washcloths or some paper towels. Damage may occur.

---

## COIL ELEMENTS (on some models)

---

### Cleaning Method:

- Damp cloth: Make sure control knobs are off and elements are cool.

Do not clean or immerse in water. Soil will burn off when hot.

For more information, see “Coil Elements and Burner Bowls.”

---

## BURNER BOWLS (on some models)

---

### Cleaning Method:

#### Chrome only

- Solution of ½ cup (125 mL) ammonia to 1 gal. (3.75 L) water:  
Soak for 20 minutes, then scrub with stainless steel-wool pad.
- Oven cleaner: Follow product label instructions.
- Mildly abrasive cleanser: Scrub with wet scouring pad.

#### Porcelain enamel only

- Dishwasher
- Gas Grate and Drip Pan Cleaner Part Number 31617 (not included):  
See “Assistance or Service” section to order.

---

## SURFACE UNDER COOKTOP (on some models)

---

For more information, see “Lift-up Cooktop” section.

### Cleaning Method:

- Steel-wool pad

Do not remove the cooktop to avoid product damage.

---

## OVEN DOOR EXTERIOR

---

### Cleaning Method:

- Glass cleaner and a soft cloth or sponge:  
Apply glass cleaner to soft cloth or sponge, not directly on panel.
- All-Purpose Appliance Cleaner Part Number 31662 (not included):  
See “Assistance or Service” section to order.

---

## OVEN CAVITY

---

Food spills should be cleaned when oven cools. At high temperatures, foods react with porcelain and staining, etching, pitting or faint white spots can result.

### Cleaning Method:

- Self-Cleaning cycle: See “Self-Cleaning Cycle” first.

Do not use oven cleaners.

---

## OVEN RACKS AND ROASTING RACKS

---

### Cleaning Method:

- Self-Cleaning cycle: See “Self-Cleaning Cycle” first. Remove racks or they will discolor and become harder to slide. If this happens, a light coating of vegetable oil applied to the rack guides will help them slide.
- Steel-wool pad

---

## BROILER PAN AND GRID (on selected models)

---

### Cleaning Method:

#### Chrome only

- Mildly abrasive cleanser:  
Scrub with wet scouring pad.
- Solution of ½ cup (125 mL) ammonia to 1 gal. (3.75 L) water:  
Soak for 20 minutes, then scrub with scouring or steel-wool pad.
- Oven cleaner: Follow product label instructions.

#### Porcelain enamel only

- Dishwasher

Do not clean in the Self-Cleaning cycle.

---

## STORAGE DRAWER (on some models)

---

Make sure drawer is cool and empty before cleaning.

For more information, see “Storage Drawer” section.

### Cleaning Method:

- Mild detergent

#### Drawer Liner (on some models)

Remove all stored items from drawer and lift out drawer liner.

- Clean with mild detergent.
- All-Purpose Appliance Cleaner Part Number 31662 (not included):  
See “Assistance or Service” section to order.

---

## WARMING DRAWER and TRAY (on some models)

---

Make sure drawer is cool and remove tray.

### Cleaning Method:

- Mild detergent (for both)
- All-Purpose Appliance Cleaner Part Number 31662 (not included):  
See “Assistance or Service” section to order.

---

## Oven Light

The oven light is a standard 40-watt appliance bulb. It will come on when the oven door is open. When the oven door is closed, press OVEN LIGHT to turn it on or off. It will not work during the Self-Cleaning cycle.

### To Replace:

1. Unplug range or disconnect power.
2. Turn the glass bulb cover in the back of the oven counterclockwise to remove.

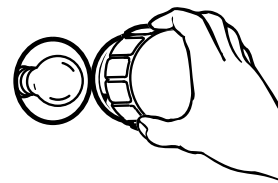

3. Turn bulb counterclockwise to remove from socket.
4. Replace bulb and bulb cover by turning clockwise.
5. Plug in range or reconnect power.

## Oven Door

For normal range use, it is not suggested to remove the oven door. However, if removal is necessary, make sure the oven is off and cool. Then, follow these instructions. The oven door is heavy.

### To Remove:

1. Open oven door all the way.
2. Flip up the hinge latch on each side.

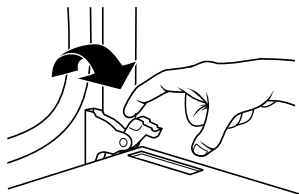

3. Close the oven door as far as it will shut.
4. Lift the oven door while holding both sides.  
Continue to push the oven door closed and pull it away from the oven door frame.

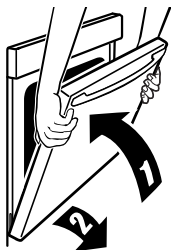

### To Replace:

1. Insert both hanger arms into the door.



2. Open the oven door.  
You should hear a “click” as the door is set into place.
3. Move the hinge levers back to the locked position. Check that the door is free to open and close. If it is not, repeat the removal and installation procedures.

## Storage Drawer

The storage drawer can be removed. Before removing, make sure drawer is cool and empty.

### To Remove:

1. Pull the storage drawer straight back past the drawer stop notch and the end of the side rails.

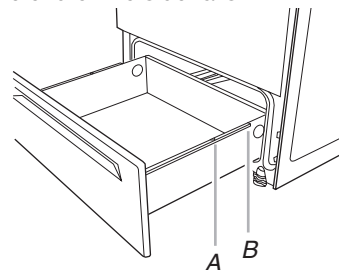

A. Drawer stop notch  
B. End of side rail

2. Lift up the back of the drawer and pull the drawer out.

### To Replace:

1. Lift up the back of the drawer and place it inside the range in its fully forward position.
2. Lift up the front of the drawer to a level position.
3. Slowly push the drawer into the range until the drawer side rails engage with the gap in the drawer glides.

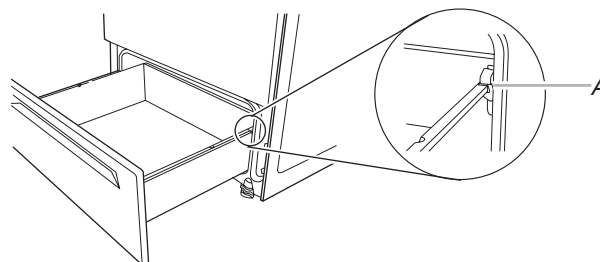

A. Engage drawer glide.

4. Once the drawer is fully engaged on both sides, slide the drawer back into the closed position.

**NOTE:** When you are removing and replacing the storage drawer, a slight push may be needed to move the drawer stop notch past the drawer glides.

## Warming Drawer (on some models)

Remove all items from inside the warming drawer, and allow the range to cool completely before attempting to remove the drawer.

### To Remove:

1. Open drawer to its fully open position.
2. Locate the black triangle-shaped tabs on both sides of the drawer.

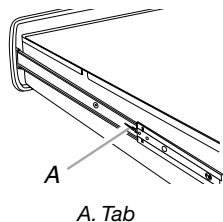

3. Press the tab down on the right side, and lift tab up on the left side at the same time, then pull drawer out another inch.

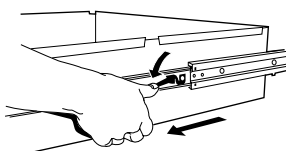

4. Holding the drawer by its sides, slowly pull it all the way out.

### To Replace:

1. Align the drawer glides with the receiving guides.

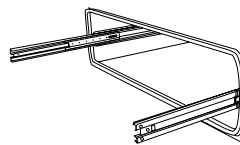

2. Push drawer in all the way.
3. Gently open and close the drawer to ensure it is seated properly on the slides.

## TROUBLESHOOTING

Try the solutions suggested here first in order to avoid the cost of an unnecessary service call.

### Nothing will operate

- **Is the power supply cord unplugged?**  
Plug into a grounded outlet.
- **Has a household fuse blown, or has a circuit breaker tripped?**  
Replace the fuse or reset the circuit breaker. If the problem continues, call an electrician.

### Cooktop will not operate

- **Is the control knob set correctly?**  
Push in knob before turning to a setting.
- **On ceramic glass models, is the oven control lockout set?**  
See "Oven Control Lockout" section.

### Excessive heat around cookware on cooktop

- **Is the cookware the proper size?**  
Use cookware about the same size as the surface cooking area, element or surface burner. Cookware should not extend more than 1/2" (1.3 cm) outside the cooking area.

### Hot Surface indicator light stays on

- **Does the Hot Surface indicator light stay on after control knob(s) have been turned off?**  
See "Cooktop Controls" section.

### Cooktop cooking results not what expected

- **Is the proper cookware being used?**  
See "Cookware" section.
- **Is the control knob set to the proper heat level?**  
See "Cooktop Controls" section.
- **Is the appliance level?**  
Level the appliance. See the Installation Instructions.

---

## Oven will not operate

---

- **Is the electronic oven control set correctly?**  
See “Electronic Oven Controls” section.
- **Has a delay start been set?**  
See “Timed Cooking” section.
- **On some models, is the oven control lockout set?**  
See “Oven Control Lockout” section.

---

## Oven temperature too high or too low

---

- **Does the oven temperature calibration need adjustment?**  
See “Oven Temperature Control” section.
- **On some models, does the cooling fan run during BAKE, BROIL or CLEAN?**  
It is normal for the fan to automatically run when the oven is in use. This helps cool the electronic control.

---

## Oven indicator lights flash

---

- **Do the oven indicator lights flash?**  
See the “Display” and/or the “Oven Indicator Lights” section. If the indicator light(s) keeps flashing, call for service. See “Assistance or Service” section.

---

## Display shows messages

---

- **Is the display showing a flashing time?**  
There has been a power failure. Clear the display. See “Display(s)” section. On some models, reset the clock, if needed. See “Clock” section.
- **Is the display showing a letter followed by a number?**  
Depending on your model, press OFF/CANCEL, OFF or CANCEL/OFF to clear the display. See “Display(s)” section. If it reappears, call for service. See “Assistance or Service” section.

---

## Self-Cleaning cycle will not operate

---

- **Is the oven door open?**  
Close the oven door all the way.
- **Has the function been entered?**  
See “Self-Cleaning Cycle” section.
- **On some models, has a delay start Self-Clean cycle been set?**  
See “Self-Cleaning Cycle” section.
- **Has a delay start been set?**  
See “Timed Cooking” section.

---

## Oven cooking results not what expected

---

- **Is the appliance level?**  
Level the appliance. See the Installation Instructions.
- **Is the proper temperature set?**  
Double-check the recipe in a reliable cookbook.
- **Is the proper oven temperature calibration set?**  
See “Oven Temperature Control” section.
- **Was the oven preheated?**  
See “Baking and Roasting” section.
- **Is the proper bakeware being used?**  
See “Bakeware” section.
- **Are the racks positioned properly?**  
See “Positioning Racks and Bakeware” section.
- **Is there proper air circulation around bakeware?**  
See “Positioning Racks and Bakeware” section.
- **Is the batter evenly distributed in the pan?**  
Check that batter is level in the pan.
- **Is the proper length of time being used?**  
Adjust cooking time.
- **Has the oven door been opened while cooking?**  
Oven peeking releases oven heat and can result in longer cooking times.
- **Are baked items too brown on the bottom?**  
Move rack to higher position in the oven.
- **Are pie crust edges browning early?**  
Use aluminum foil to cover the edge of the crust and/or reduce baking temperature.

---

# ASSISTANCE OR SERVICE

Before calling for assistance or service, please check “Troubleshooting.” It may save you the cost of a service call. If you still need help, follow the instructions below.

When calling, please know the purchase date and the complete model and serial number of your appliance. This information will help us to better respond to your request.

## If you need replacement parts

If you need to order replacement parts, we recommend that you use only FSP® replacement parts. FSP® replacement parts will fit right and work right because they are made with the same precision used to build every new WHIRLPOOL® appliance.

To locate FSP® replacement parts in your area, call us or your nearest Whirlpool designated service center.

---

## In the U.S.A.

Call the Whirlpool Customer eXperience Center toll free: **1-800-253-1301**.

### Our consultants provide assistance with:

- Features and specifications on our full line of appliances.
- Installation information.
- Use and maintenance procedures.
- Accessory and repair parts sales.
- Specialized customer assistance (Spanish speaking, hearing impaired, limited vision, etc.).
- Referrals to local dealers, repair parts distributors and service companies. Whirlpool designated service technicians are trained to fulfill the product warranty and provide after-warranty service, anywhere in the United States.

To locate the Whirlpool designated service company in your area, you can also look in your telephone directory Yellow Pages.

### For further assistance

If you need further assistance, you can write to Whirlpool Corporation with any questions or concerns at:

Whirlpool Brand Home Appliances  
Customer eXperience Center  
553 Benson Road  
Benton Harbor, MI 49022-2692

Please include a daytime phone number in your correspondence.

## Accessories U.S.A.

To order accessories, call the Whirlpool Customer eXperience Center toll free at **1-800-442-9991** and follow the menu prompts. Or visit our website at **www.whirlpool.com** and click on “Parts & Accessories.”

## Canning Unit Kit

(coil element models)

Order Part Number 242905

## Cooktop Cleaner

(ceramic glass models)

Order Part Number 31464

## Cooktop Protectant

Order Part Number 31463

## Cooktop Care Kit

(includes cleaner, protectant, and applicator pads)

Order Part Number 31605

## Cooktop Scraper

(ceramic glass models)

Order Part Number 3183488

## Stainless Steel Cleaner & Polish

(stainless steel models)

Order Part Number 31462

## All-Purpose Appliance Cleaner

Order Part Number 31662

## Split-Rack with Removable Insert

Order Part Number 4396927

---

# WHIRLPOOL CORPORATION MAJOR APPLIANCE WARRANTY

---

## ONE YEAR LIMITED WARRANTY

For one year from the date of purchase, when this major appliance is operated and maintained according to instructions attached to or furnished with the product, Whirlpool Corporation or Whirlpool Canada LP (hereafter "Whirlpool") will pay for Factory Specified Parts and repair labor to correct defects in materials or workmanship. Service must be provided by a Whirlpool designated service company. This limited warranty applies only when the major appliance is used in the country in which it was purchased.

---

### ITEMS WHIRLPOOL WILL NOT PAY FOR

1. Service calls to correct the installation of your major appliance, to instruct you how to use your major appliance, to replace or repair house fuses or to correct house wiring or plumbing.
  2. Service calls to repair or replace appliance light bulbs, air filters or water filters. Those consumable parts are excluded from warranty coverage.
  3. Repairs when your major appliance is used for other than normal, single-family household use.
  4. Damage resulting from accident, alteration, misuse, abuse, fire, flood, acts of God, improper installation, installation not in accordance with electrical or plumbing codes, or use of products not approved by Whirlpool.
  5. Any food loss due to refrigerator or freezer product failures.
  6. Replacement parts or repair labor costs for units operated outside the United States or Canada.
  7. Pickup and delivery. This major appliance is designed to be repaired in the home.
  8. Repairs to parts or systems resulting from unauthorized modifications made to the appliance.
  9. Expenses for travel and transportation for product service in remote locations.
  10. The removal and reinstallation of your appliance if it is installed in an inaccessible location or is not installed in accordance with published installation instructions.
  11. Replacement parts or repair labor costs when the major appliance is used in a country other than the country in which it was purchased.
- 

### DISCLAIMER OF IMPLIED WARRANTIES; LIMITATION OF REMEDIES

CUSTOMER'S SOLE AND EXCLUSIVE REMEDY UNDER THIS LIMITED WARRANTY SHALL BE PRODUCT REPAIR AS PROVIDED HEREIN. IMPLIED WARRANTIES, INCLUDING WARRANTIES OF MERCHANTABILITY OR FITNESS FOR A PARTICULAR PURPOSE, ARE LIMITED TO ONE YEAR OR THE SHORTEST PERIOD ALLOWED BY LAW. WHIRLPOOL SHALL NOT BE LIABLE FOR INCIDENTAL OR CONSEQUENTIAL DAMAGES. SOME STATES AND PROVINCES DO NOT ALLOW THE EXCLUSION OR LIMITATION OF INCIDENTAL OR CONSEQUENTIAL DAMAGES, OR LIMITATIONS ON THE DURATION OF IMPLIED WARRANTIES OF MERCHANTABILITY OR FITNESS, SO THESE EXCLUSIONS OR LIMITATIONS MAY NOT APPLY TO YOU. THIS WARRANTY GIVES YOU SPECIFIC LEGAL RIGHTS AND YOU MAY ALSO HAVE OTHER RIGHTS, WHICH VARY FROM STATE TO STATE OR PROVINCE TO PROVINCE.

---

Outside the 50 United States and Canada, this warranty does not apply. Contact your authorized Whirlpool dealer to determine if another warranty applies.

If you need service, first see the "Troubleshooting" section of the Use & Care Guide. After checking "Troubleshooting," additional help can be found by checking the "Assistance or Service" section or by calling Whirlpool. In the U.S.A., call **1-800-253-1301**. In Canada, call **1-800-807-6777**. 12/05

---

**Keep this book and your sales slip together for future reference. You must provide proof of purchase or installation date for in-warranty service.**

Write down the following information about your major appliance to better help you obtain assistance or service if you ever need it. You will need to know your complete model number and serial number. You can find this information on the model and serial number label located on the product.

Dealer name \_\_\_\_\_  
Address \_\_\_\_\_  
Phone number \_\_\_\_\_  
Model number \_\_\_\_\_  
Serial number \_\_\_\_\_  
Purchase date \_\_\_\_\_

