

400 CFM Integral Blower
VTN1DZ



Product Features



Notes: Please refer to installation instructions. Installation instructions are available at www.thermador.com. Specifications are correct at the time of printing. Thermador reserves the right to change product specifications and design at any time, without notice.

1 800 735 4328 | WWW.THERMADOR.COM | 1901 Main Street, Suite 600 Irvine, CA 92614

©2022 BSH HOME APPLIANCES CORPORATION, ALL RIGHTS RESERVED LITHO DATE: 04/2022

400 CFM Integral Blower
VTN1DZ

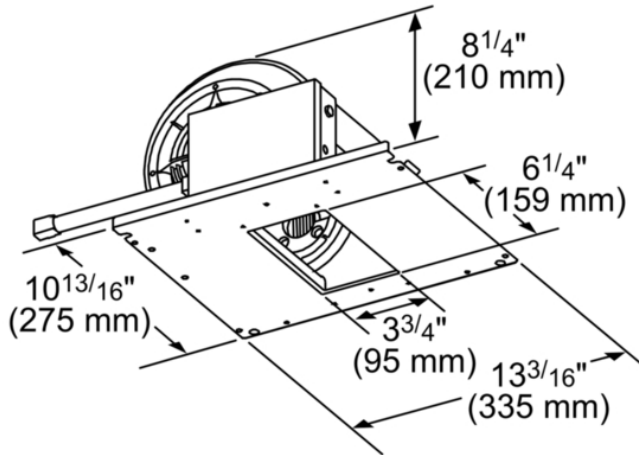

measurements in inches (mm)

Product Features

	Accessory
Brand	Thermador
SKU	VTN1DZ
Internal article number	VTN1DZ
EAN code	825225964896
Product packaging dimensions (HxWxD)	11.6" x 20.0" x 13.2"
	11
	13
UPC code	825225964896
Product image	19805476_VTN1DZ_Front_Facing_def.jpg

Technical Specification

Notes: Please refer to installation instructions. Installation instructions are available at www.thermador.com. Specifications are correct at the time of printing. Thermador reserves the right to change product specifications and design at any time, without notice.

1 800 735 4328 | WWW.THERMADOR.COM | 1901 Main Street, Suite 600 Irvine, CA 92614

©2022 BSH HOME APPLIANCES CORPORATION, ALL RIGHTS RESERVED LITHO DATE: 04/2022