

ZOM-E30BBS
ZOM-E30BS
ZOM-E36BBS
ZOM-E36BS

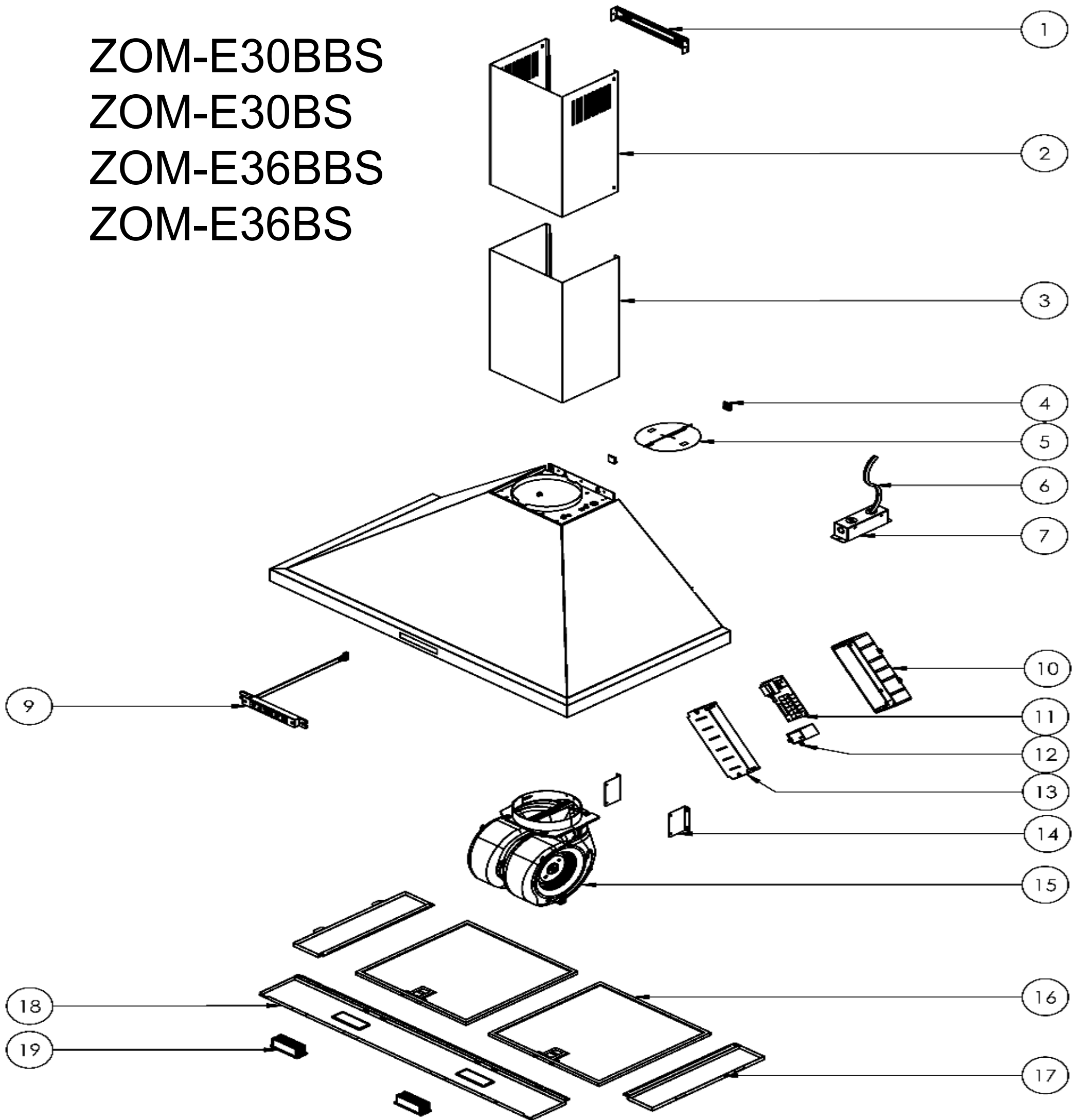



Ombra Wall

ZOM-E30BBS, ZOM-E30BS, ZOM-E36BBS, ZOM-E36BS

Ref #	Part #	Description	Qty.
1	54110052	Duct Cover Wall Bracket	1
2	50050185	Upper Duct Cover, Black Stainless	1
2	50050192	Upper Duct Cover, Stainless Steel	1
3	50050186	Lower Duct Cover, Black Stainless	1
3	50050193	Lower Duct Cover, Stainless Steel	1
4	50180002	Damper Clip	2
5	54060004	6" Round Damper	1
6	11030139	Electrical Wires	1
7	56200081	Electrical Junction Box	1
9	11000157	Switch Assembly	1
10	56200051	Component Box	1
11	11010133	Control Board	1
12	12050021	Capacitor	1
13	56210024	Component Box Cover	1
14	54140076	Motor Bracket	2
15	12120089	Motor	1
16	50200059	Aluminum Mesh Filter	2
17	50120135	Side Panel (ZOM-E36BBS)	2
17	50120159	Side Panel (ZOM-E36BS)	2
18	50110328	Light Panel (ZOM-E30BBS)	1
18	50110329	Light Panel (ZOM-E30BS)	1
18	50110330	Light Panel (ZOM-E36BBS)	1
18	50110331	Light Panel (ZOM-E36BS)	1
19	Z0B0047	LumiLight LED, 6W	2
20	05000130	Hardware Packet	1