

DF36450G/S/P



FEATURES

Wolf's patented gas dual-stacked, sealed burner design provides precise high-to-low temperature control and a spark ignition system that reignites the burner automatically

Wolf's Dual VertiCross™ convection system provides reliably even heat, reduces hot and cold spots, and enables consistent multi-rack cooking

Gourmet Mode features nearly 50 presets that automatically control the oven to ensure delicious results

Ten cooking modes, including Bake, Broil, Convection, Convection Roast, Dehydrate, Gourmet, Proof, Roast, Stone, and Warm, were developed by Wolf chefs to maximize the performance of your oven

The redesigned 15,000 Btu griddle features even, precise heat, handling breakfast with equal finesse as seared burgers and stir-fried vegetables

Four dual-stacked burners produce up to 20,000 Btu for fast boils and intense sears and 300 Btu for true simmers and worry-free melts

For improved temperature control and safety, the spark ignition system reignites burners automatically

The full-color touch screen is intuitive and easy to read, discreetly hiding away when not in use

LED backlit control knobs illuminate when in use, indicating which burners are active

The oven offers self-clean, delayed start, timed cook, and Sabbath features

The temperature probe alerts you when your dish has reached the desired temperature

The oven's Wi-Fi enabled feature lets you remotely preheat, select modes, and adjust oven temperature from your mobile device

Create a cohesive look in your kitchen with the range's stainless steel construction, pro style handles, and choice of iconic red, black, or brushed stainless knobs

ACCESSORIES

11" Cutting Board

2-Burner Wok Grate

36" Dehydration Rack Set

36" Full-extension ball-bearing oven rack

36" Standard Oven Rack

Bake Stone Kit

Black Knobs

Filler Trim

Griddle Cleaning Kit

Griddle Cleaning Pads

Griddle Cleaning Solution

Stainless Steel Knobs

Temperature Probe

Rear Caster Covers



KNOB OPTIONS



TOP CONFIGURATION

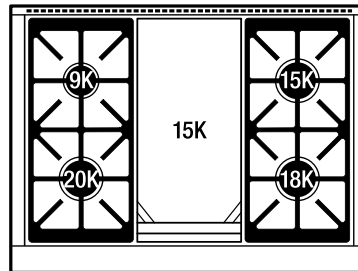

RANGETOP SPECIFICATIONS

- 1 - 9,200 Btu burner
- 1 - 15,000 Btu burner
- 1 - 18,000 Btu burner
- 1 - 20,000 Btu burner
- 1 - 15,000 Btu (14,000 Btu LP) griddle
- Stainless-steel griddle cover
- Stainless-steel island trim riser included

Front Leg Extension Covers

Stainless Steel Kickplates

5" and 10" stainless steel risers, and 20" riser with shelf

Accessories available through an authorized dealer.

For local dealer information, visit subzero-wolf.com/locator.

Specifications are subject to change without notice. This information was generated on August 18, 2021. Verify specifications prior to finalizing your cabinetry/enclosures.

PRODUCT SPECIFICATIONS

Model	DF36450G/S/P
Dimensions	35 7/8"W x 36 1/2"H x 29 1/2"D
Oven 1 Interior Dimensions	31 1/4"W x 17 1/2"H x 20"D
Oven 1 Usable Capacity	4.1 cu. ft.
Oven 1 Overall Capacity	6.3 cu. ft.
Door Clearance	20 3/8"
Electrical Supply	240/208 VAC, 60 Hz
Electrical Service	30 amp dedicated circuit
Gas Supply	3/4" ID line
Gas Inlet	1/2" NPT female

ELECTRICAL

GAS

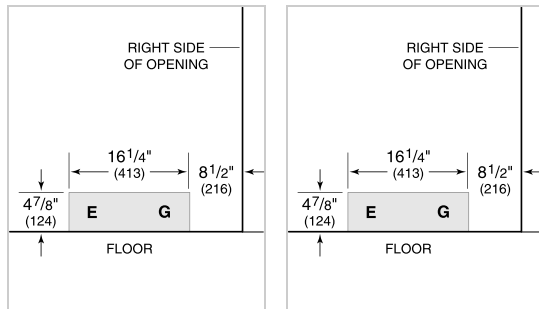

NOTE: Dimensions in parenthesis are in millimeters unless otherwise specified

DIMENSIONS

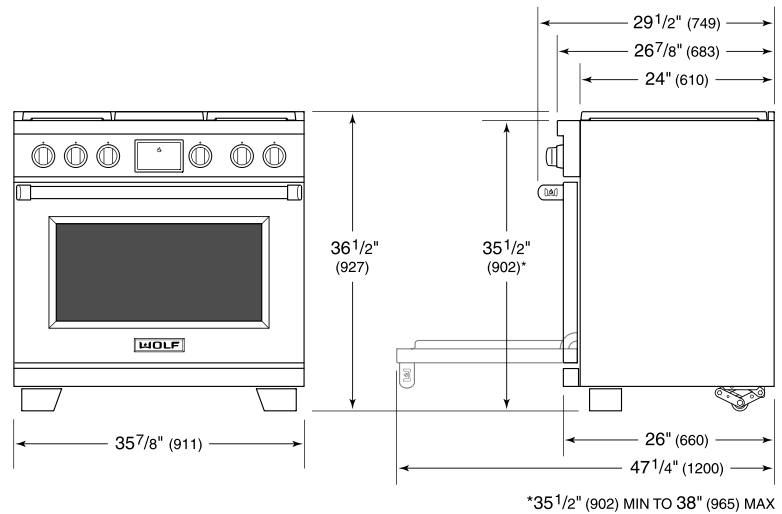

STANDARD INSTALLATION

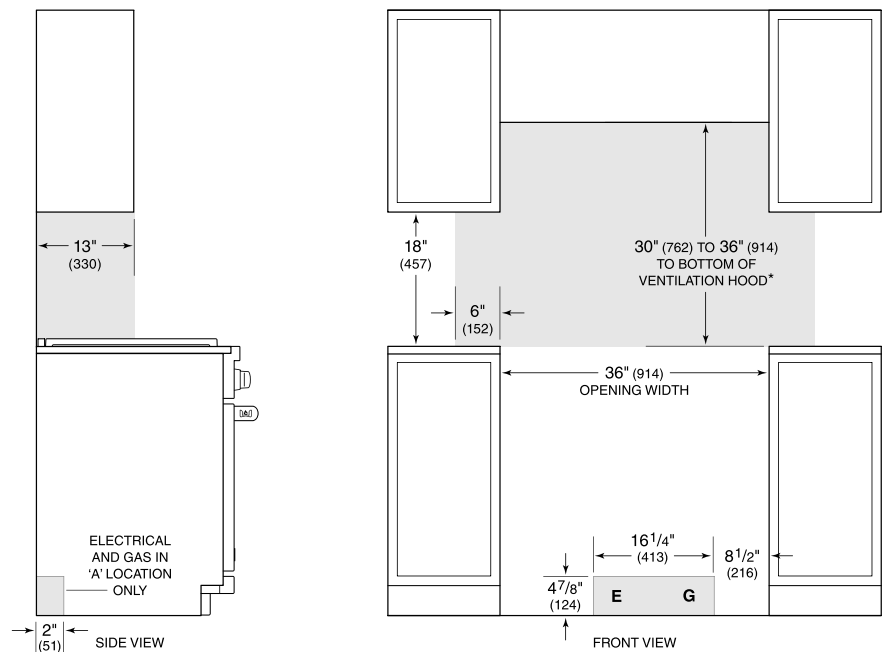

*Without ventilation hood, 36" (914) minimum clearance countertop to combustible materials, 44" (1118) for charbroiler.

NOTE: Shaded area above countertop indicates minimum clearance to combustible surfaces, combustible materials cannot be located within this area.

For island installation, 12" (305) minimum clearance back of range to combustible rear wall above countertop.