

Fresh Living Tip

Never seem to have enough space in your refrigerator for beverages? Simply swap a 15" cabinet with this slim model to easily add more cold storage to your home. And if built-in installation is not an option, the finished cabinet design makes for a polished freestanding look.

FINISH OPTIONS

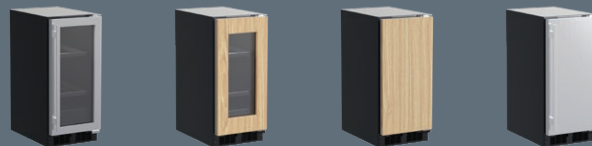

15" Marvel Beverage Center

MLBV215

Storage Adaptability

- 2.7 cu. ft. capacity stores (72) 12-oz cans and 3 wine bottles
- Black steel-framed glass shelves are cantilevered and fully adjustable
- Includes (1) 3-in-1 Convertible Shelf featuring removable glass pane with wine rack option
- Store food, beverages, or wine

Cooling Performance

- Dynamic cooling technology delivers rapid cool down, frost-free operation and precise temperature stability
- Proprietary shelving design for cool air to circulate throughout cabinet for temperature consistency from top to bottom
- Thermal-efficient cabinet ensures optimum preservation and energy efficiency while maximizing capacity
- Argon-filled, UV-resistant tinted dual pane glass door protects contents from damaging ultraviolet light, while conserving energy
- Sound-buffering design

Convenient Controls

- Multifunction controls allow you to select a precise cabinet temperature from 34° F to 60° F
- Features easy-to-use settings and options

Fit & Finish

- Elegant midnight black interior and arctic white LED interior lighting
- Solid black shelf fronts
- Reversible door allows for right or left swing for adaptable installation
- Black toe kick adjustable to 4" with leveling legs

Warranty

- 1-year parts and labor warranty and 5-year sealed system parts warranty



Full-featured in a slim size, this 15" beverage center stores up to six 12-packs, and a convertible shelf lifts to reveal hidden wine storage!

DOOR STYLE	MODEL NUMBER
Stainless Steel Frame Glass	MLBV215-SG01A
Panel Ready Frame Glass	MLBV215-IG01A
Solid Panel Ready	MLBV215-IS01A
Solid Stainless Steel	MLBV215-SS01A



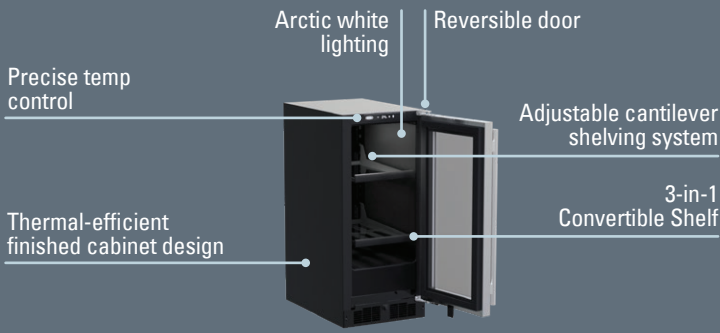

H: 33 3/4" W: 14 7/8" D: 26 7/32" (with handle)

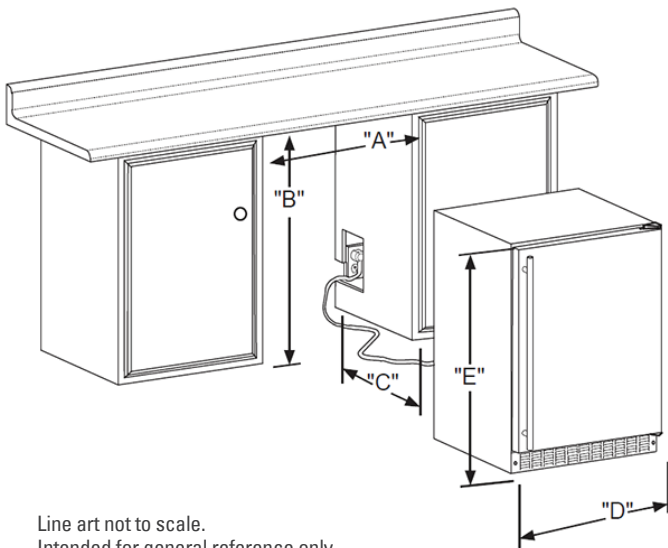

Line art not to scale.
Intended for general reference only.

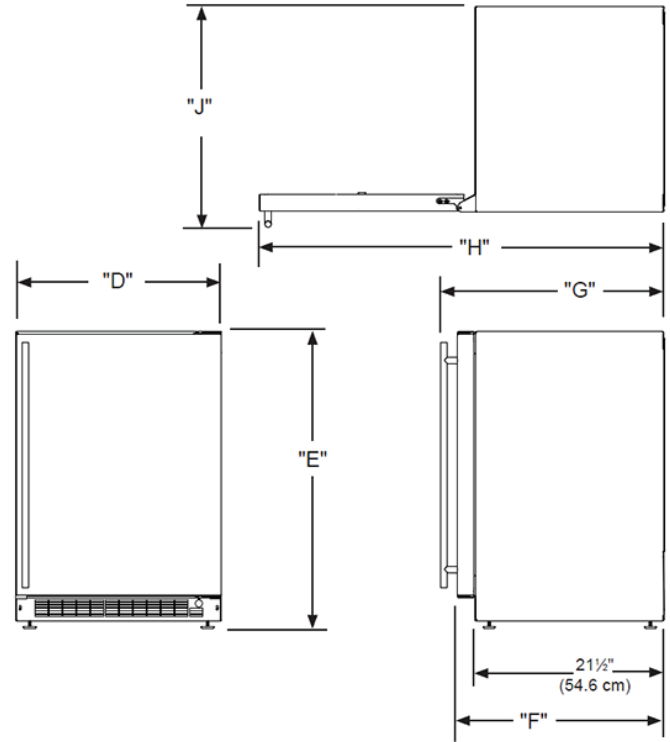

Rough In Dimensions*

"A"	"B"	"C"
15"	34-1/4" TO 35-1/4"	24"
(38.1 CM)	(87 CM TO 89.5 CM)	(61 CM)

Cabinet Dimensions*

"D"	"E"	"F"	"G"	"H"	"J"
14-7/8"	33-5/8" TO 34-5/8"	23-5/8"*	25-3/8"*	38-3/4"*	17-1/2"*
(37.8 CM)	(85.4 CM TO 87.9 CM)	(60 CM)	(64.4 CM)	(98.4 CM)	(44.4 CM)

*Stainless steel model dimensions only. For panel-ready models, see the owner's guide online at marvelrefrigeration.com.

Capacity	2.7 CU. FT.
Control Type	Electronic
Sabbath Mode	Yes
Temperature Range	34° F to 60° F
Handle Style	Slim (handle not included on panel-ready models)
Hinge Type	Reversible
Interior Lighting	White LED
Shelving System	Cantilevered
Toe Grille Finish	Black

Lock	No
Electrical Requirements	115V / 60 Hz / 15A
Cord Length	6 FT.
Shipping Dimensions	19" W x 31" D x 37" H
Shipping Weight	125 LBS
Agency Approval	UL
Refrigerant Type	R600a

For comprehensive installation instructions, including panel overlay details, please visit marvelrefrigeration.com to access the owner's guide.

