

ID-24F



## FEATURES

Accepts custom panels for an integrated look within cabinetry or stainless-steel accessory panels and handles to match other Sub-Zero, Wolf, and Cove products

Controls temperature within one degree of setpoint

Locks in cold air to ensure freshness with magnetic door seals

Control brightness with soft-on LED lighting

Open and close doors silently with soft-close technology

## ACCESSORIES

Dual Installation Kit

Reduced Toekick Divider

Stainless Steel Pro Handles

Stainless Steel Tubular Handles

Stainless Steel Drawer Panels With Pro Handles - 4" Toe Kick

Stainless Steel Drawer Panels With Pro Handles - 6" Toe Kick

Stainless Steel Drawer Panels With Tubular Handles - 4" Toe Kick

Stainless Steel Drawer Panels With Tubular Handles - 6" Toe Kick

Stainless Steel Dual Installation Kickplates

Accessories are available through an authorized dealer.  
For local dealer information, visit [subzero-wolf.com/locator](http://subzero-wolf.com/locator).



## PRODUCT DETAILS

### FREEZER

- Adjustable drawer dividers
- LED lighting

**PRODUCT SPECIFICATIONS**

Model	ID-24F
Dimensions	24"W x 34 1/2"H x 24"D
Drawer Clearance	18 3/8"
Weight	185 lbs
Freezer Capacity	3.8 cu. ft.
Electrical Supply	115 VAC, 60 Hz
Electrical Service	15 amp dedicated circuit

**ELECTRICAL**

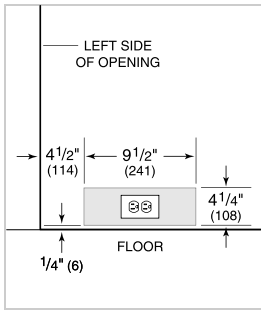

NOTE: Dimensions in parenthesis are in millimeters unless otherwise specified

**INTERIOR VIEW**

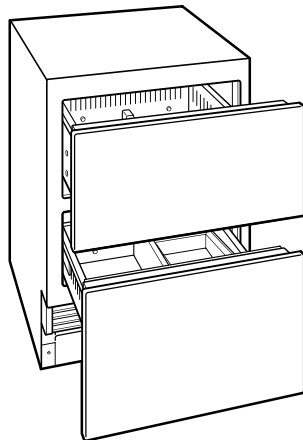

This illustration is intended for interior reference only and may not represent the exterior of the model being specified.

**DIMENSIONS**

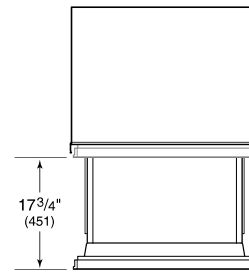
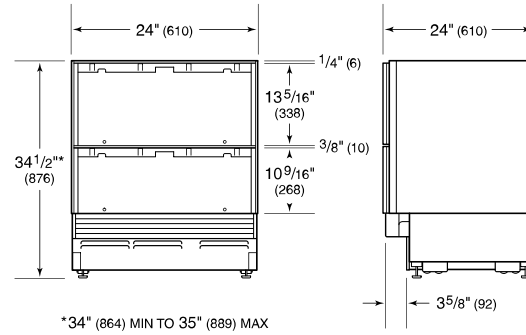

**STANDARD INSTALLATION**

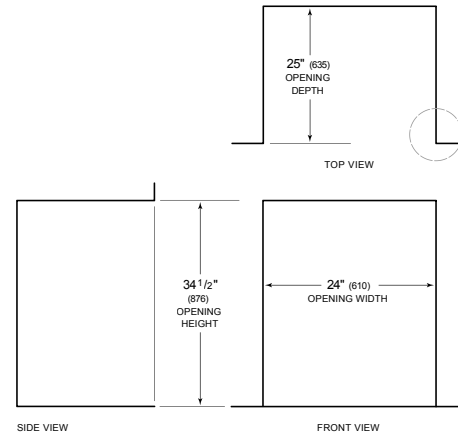

NOTE: 3 1/2" (89) finished returns will be visible and should be finished to match cabinetry

