

IMPORTANT

Carefully remove all the parts from the carton and place them individually on a soft cloth to prevent scratches or other damage.

Carefully and strictly follow these assembly instructions to ensure a completed product as designed.

Do not use power tools above 8 volts to assemble.

Part List

G.
Front Rail
1 pc.

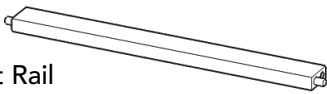

H.
Front Rail
1 pc.

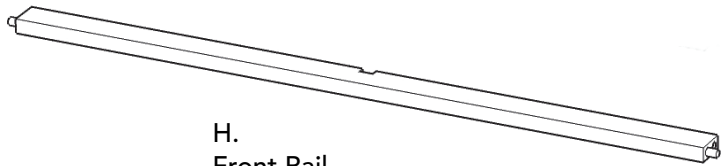

I.
Base
1 pc.

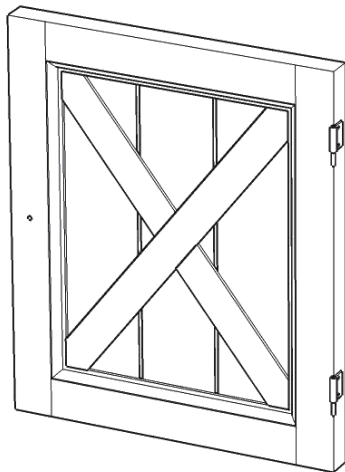
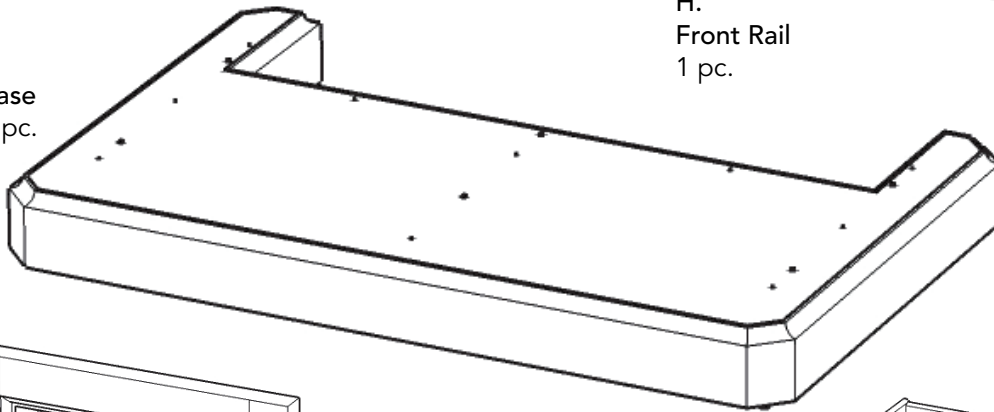

J.
Door
1 pc.

L.
Drawer
2 pcs.

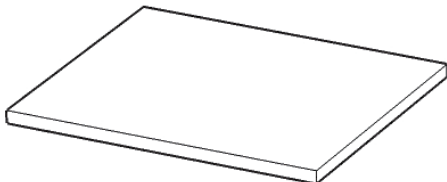
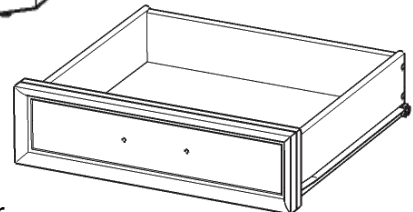

K.
Shelf
2 pcs.

M.
Drawer
2 pcs.

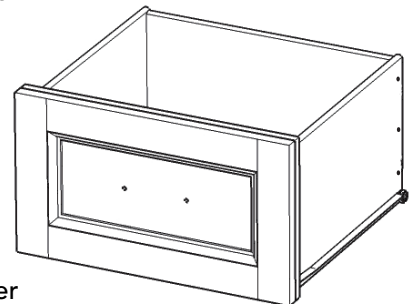

Refer to 20 05525 0942 assembly instructions for drawer assembly.

For assembly see instructions in carton 20 05525 0942.