

Use & Care Manual

Electric Range

CONTENTS

	Page
Versión en español	2
Product Registration	2
Important Safety Instructions	3-5
Selecting Surface Cooking Utensils	6
Specialty Pans & Trivets	6
Canning Tips & Information	7
Setting Surface Controls	7-9
To Operate the Warmer Zone	10
Oven Vent(s) and Racks	11
Air Circulation in the Oven	11
Oven Baking Informations	12
Broiling Informations	13
Convection Cooking and Baking	14
Convection Roasting	14
Setting Side Oven Control	15
Self-Clean Oven Cycle	16
Porcelain Enamel Oven	
Cleaning (Side Oven, If equipped)	17
To Clean the Oven Bottom	17
To Clean the Cooktop Glass	18-19
Cleaning Various Parts of your Range	120-22
To Remove and Replace Right Oven Door	22
To Remove and Replace Storage Drawer	22
Changing Cooktop and / or Oven Light	23
Avoid Service Checklist	24-25
Notes	26-27
Warranty	28

Visit the Frigidaire Web Site at:
<http://www.frigidaire.com>

Product Registration

Register Your Product

The **PRODUCT REGISTRATION CARD** should be filled in completely, signed and returned to Electrolux Home Products North America.

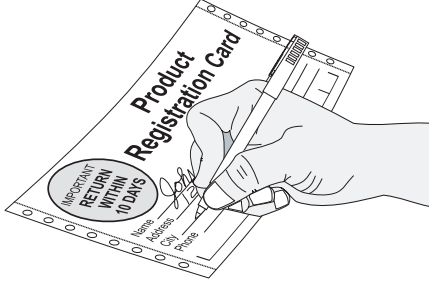

Versión en español

Si desea obtener una copia en español de este Manual del Usuario, sírvase escribir a la dirección que se incluye a continuación. Solicite la P/N **318204018**.

Electrolux Home Products
Attn: Care Use
P.O. Box 212378
Augusta, GA 30917

Thank you for choosing this appliance. The information contained within this **Owner's Guide** will instruct you on how to properly operate and care for your range. Please read through the information contained in your literature pack to learn more about your new appliance.

Record Your Model and Serial Numbers

Record in the space provided below the model and serial numbers found on the serial plated located along the upper left corner of the oven frame behind the small oven door.

Model Number: _____

Serial Number: _____

Date of Purchase: _____

This Owner's Guide contains general operating instructions for your range and feature information for several models. Your appliance **may not** have all the described features and appearance.

Note: The instructions appearing in this Owner's Guide are not meant to cover every possible condition and situation that may occur. Common sense and caution must be practiced when installing, operating and maintaining any appliance.

IMPORTANT SAFETY INSTRUCTIONS

Read all instructions before using this appliance.

Save these instructions for future reference.

This manual contains many important safety messages. Always read and obey all safety messages.

The safety alert symbol  calls your attention to safety messages that inform you of hazards that can kill or hurt you or others, or cause damage to the product.

⚠ WARNING Indicates an imminently hazardous situation which, if not avoided may result in death or serious injury.

⚠ CAUTION Indicates an imminently hazardous situation which, if not avoided may result in minor or moderate injury, or product-damage-only.

All safety messages will identify the hazard, tell you how to reduce the chance of injury, and tell you what can happen if the instructions are not followed.



⚠ WARNING

- All ranges can tip.
- Injury to persons could result.
- Install anti-tip device packed with range.
- See Installation Instructions.



To reduce the risk of tipping, the range must be secured by properly installed anti-tip bracket(s) provided with the range. To check if the bracket(s) is (are) installed properly, remove the lower panel or storage drawer and verify that the anti-tip bracket(s) is (are) engaged. Refer to the Installation Instructions for proper anti-tip bracket(s) installation.

• **Remove all tape and packaging before using the range.** Destroy the carton and plastic bags after unpacking the range. Never allow children to play with packaging material.

• **Proper Installation—Be sure your appliance is properly installed and grounded by a qualified technician in accordance with the National Electrical Code ANSI/NFPA No. 70—latest edition, and local code requirements.** Install only per installation instructions provided in the literature package for this range.

Ask your dealer to recommend a qualified technician and an authorized repair service. Know how to disconnect the power to the range at the circuit breaker or fuse box in case of an emergency.

• **User servicing—Do not repair or replace any part of the appliance unless specifically recommended in the manuals.** All other servicing should be done only by a qualified technician, this may reduce the risk of personal injury and damage to the range.

• **Never modify or alter the construction of a range by removing leveling legs, panels, wire covers, anti-tip brackets/screws, or any other part of the product.**

⚠ WARNING Stepping, leaning or sitting on the doors or drawer of this range can result in serious injuries and also cause damage to the range. Do not allow children to climb or play around the range. The weight of a child on an open door may cause the range to tip, resulting in serious burns or other injury.

⚠ WARNING Do not use the oven for storage.

⚠ CAUTION Do not store items of interest to children in the cabinets above a range or on backguard of a range. Children climbing on the range to reach items could be seriously injured.

⚠ WARNING Never use your appliance to warming or heating the room.

• **Storage in or on Appliance—Flammable materials should not be stored in an oven, near surface units.** This includes paper, plastic and cloth items, such as cookbooks, plasticware and towels, as well as flammable liquids. Do not store explosives, such as aerosol cans, on or near the appliance. Flammable materials may explode and result in fire or property damage.

IMPORTANT SAFETY INSTRUCTIONS

- **Do not leave children alone—Children should not be left alone or unattended in the area where appliance is in use.** They should never be allowed to sit or stand on any part of the appliance.
- **DO NOT TOUCH SURFACE UNITS, AREAS NEAR THESE UNITS, OVEN HEATING ELEMENTS OR INTERIOR SURFACES OF THE OVEN.** Both surface and oven heating elements may be hot even though they are dark in color. Areas near surface units may become hot enough to cause burns. During and after use, do not touch, or let clothing or other flammable materials touch these areas until they have had sufficient time to cool. Among these areas are the cooktop, surfaces facing the cooktop, the oven vent openings and surfaces near these openings, oven door and window.
- **Wear proper apparel—Loose-fitting or hanging garments should never be worn while using the appliance.** Do not let clothing or other flammable materials contact hot surfaces.
- **Do not use water or flour on grease fires—Smother the fire with a pan lid, or use baking soda, a dry chemical or foam-type extinguisher.**
- **When heating fat or grease, watch it closely.** Fat or grease may catch fire if allowed to become too hot.
- **Use only dry potholders—Moist or damp potholders on hot surfaces may result in burns from steam.** Do not let potholders touch hot heating elements. Do not use a towel or other bulky cloth instead of a potholder.
- **Do not heat unopened food containers—Build-up of pressure may cause container to burst and result in injury.**
- **Remove the oven doors from any unused range if it is to be stored or discarded.**

IMPORTANT—Do not attempt to operate the oven during a power failure. If the power fails, always turn the ovens off. If the ovens are not turned off and the power resumes, the oven may begin to operate again. Food left unattended could catch fire or spoil.

⚠ CAUTION Electronic controllers can be damaged by cold temperatures. When you use your appliance for the first time, or if it has not been used for a long period of time, make sure that it has been exposed to a temperature above 0°C/32°F for at least 3 hours before connecting it to the power supply.

IMPORTANT INSTRUCTIONS FOR USING YOUR COOKTOP

- **Know which knob controls each surface heating unit.**
- **Use proper pan size.** This appliance is equipped with one or more surface units of different sizes. Select utensils having flat bottoms large enough to cover the surface unit. The use of undersized utensils will expose a portion of the surface heating to direct contact and may result in ignition of clothing. Proper relationship of utensil to the surface unit will also improve efficiency.
- **Do Not Immerse or Soak Removable Heating Elements—** Heating elements should never be immersed in water. Heating elements clean themselves during normal operation.
- **Make sure Drip Pans or Drip Bowls Are in Place—** Absence of these pans or bowls during cooking may subject wiring or components underneath to damage.
- **Utensil handles should be turned inward and not extend over adjacent surface units—**To reduce the risk of burns, ignition of flammable materials, and spillage due to unintentional contact with the utensil. The handle of the utensil should be positioned so that it is turned inward, and does not extend over adjacent surface units.
- **Never leave surface units unattended at high heat settings—**Boilovers cause smoking and greasy spillovers that may ignite, or a pan that has boiled dry may melt.
- **Protective liners—**Do not use aluminum foil to line oven bottom or any other part of the appliance. Only use aluminum foil as recommended for baking if used as a cover placed on the food. Any other use of protective liners or aluminum foil may result in a risk of electric shock or fire or short circuit.
- **Glazed cooking utensils—**Only certain types of glass, glass/ceramic, ceramic, earthenware, or other glazed utensils are suitable for rangetop service without breaking due to the sudden change in temperature. Check the manufacturer's recommendations for rangetop use.
- **Do not use decorative surface element covers.** If an element is accidentally turned on, the decorative cover will become hot and possibly melt. Burns will occur if the hot covers are touched. Damage may also be done to the cooktop.

IMPORTANT SAFETY INSTRUCTIONS

FOR GLASS COOKTOPS ONLY

- **Do not clean or operate a broken cooktop**—If cooktop should break, cleaning solutions and spillovers may penetrate the broken cooktop and create a risk of electric shock. Contact a qualified technician immediately.
- **Clean cooktop glass with caution**—If a wet sponge or cloth is used to wipe spills on a hot cooking area, be careful to avoid a steam burn. Some cleaners can produce harmful fumes if applied to a hot surface.
- **Do not place hot cookware on cold cooktop glass.** This could cause glass to break.
- **Avoid scratching the cooktop glass with sharp objects.**

IMPORTANT INSTRUCTIONS FOR USING YOUR OVEN

- **Use care when opening oven door**—Stand to the side of the range when opening the door of a hot oven. Let hot air or steam escape before you remove or replace food in the oven.
- **Keep ovens vents unobstructed.** Each vent has its own vent located on the top, near each side and towards the back of the cooktop. Touching the surfaces in this area when the oven is operating may cause severe burns. Also, do not place plastic or heat-sensitive items on or near an oven vent. These items could melt or ignite.
- **Placement of ovens racks.** Always place oven racks in desired location while ovens are cool. If rack must be moved while oven is hot use extreme caution. Use potholders and grasp the rack with both hands to reposition. Do not let potholders contact the hot heating elements in the ovens. Remove all utensils from the rack before moving.
- **Do not use the broiler pan without its grid.** The broiler pan and its grid allow dripping fat to drain and be kept away from the high heat of the broiler.
- **Do not cover the broiler grid with aluminum foil.** Exposed fat and grease could ignite.

- **Do not touch a hot light bulb with a damp cloth.** Doing so could cause the bulb to break. Disconnect the appliance or turn off the power to the appliance before removing and replacing light bulb.

IMPORTANT INSTRUCTIONS FOR CLEANING YOUR RANGE

- **Clean the range regularly to keep all parts free of grease that could catch fire.** Exhaust fan ventilation hoods and grease filters should be kept clean. Do not allow grease to accumulate on hood or filter. Greasy deposits in the fan could catch fire. When you are flaming food under the hood, turn the fan on. Refer to the hood manufacturer's instructions for cleaning.
- **Kitchen cleaners and aerosols**—Always follow the manufacturer's recommended directions for use. Be aware that excess residue from cleaners and aerosols may ignite causing damage and injury.

SELF CLEANING OVENS

- **In the self-Cleaning cycle only clean the parts listed in this Use and Care Guide.** Before self cleaning the oven, remove the broiler pan and any utensils or foods from the oven.
- **Do not use oven cleaners**—No commercial oven cleaner or ovens liner protective coating of any kind should be used in or around any part of the oven.
- **Do not clean door gasket**—The door gasket is essential for a good seal. Care should be taken not to rub, damage or move the gasket.
- **Remove oven racks.** Oven racks color will change if left in the oven during a self-cleaning cycle.

⚠ CAUTION The health of some birds is extremely sensitive to the fumes given off during the self-cleaning cycle of any range. Move birds to another well ventilated room.

IMPORTANT SAFETY NOTICE

The California Safe Drinking Water and Toxic Enforcement Act requires the Governor of California to publish a list of substances known to the state to cause cancer, birth defects or other reproductive harm, and requires businesses to warn customers of potential exposure to such substances.

SAVE THESE INSTRUCTIONS

Selecting Surface Cooking Utensils

For best result and energy conservation, choose cooking utensils that have these characteristics:

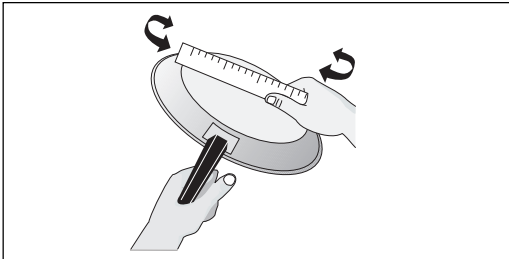

Pans should have flat bottoms. Check for flatness by rotating a ruler across the bottom. There should be no gap between the pan and ruler.

Note: Always use a utensil for its intended purpose. Follow manufacturer's instructions. Some utensils were not made to be used in the oven or on the cooktop.

CAUTION Do not use griddle over more than one burner because it could damage your cooktop. It can also result in exposure to carbon monoxide levels above allowable current standards and be hazardous to your health.

***GOOD**

- Flat bottom and straight sides.
- Tight fitting lids.
- Weight of handle does not tilt pan. Pan is well balanced.
- Pan sizes match the amount of food to be prepared and the size of the surface element.
- Made of a material that conducts heat well.
- Easy to clean.
- Always match pot diameter to element diameter.

POOR

- Curved and warped pan

- Pan overhangs unit by more than one-half inch or 12mm.

- Heavy handle tilts pan.

- Pan is smaller or larger than element

* Specialty pans such as lobster pots, griddles and pressure cookers may be used but must conform to the above recommended cookware requirements.

Specialty Pans & Trivets

Woks with flat bottoms suitable for use on your cooktop are available in most cookshop or hardware stores.

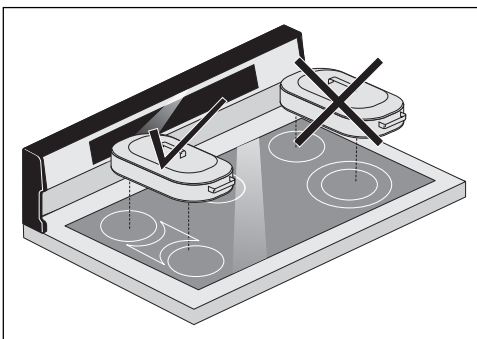

DO NOT use two elements (if the cooktop is not equipped with bridge element) to heat one large pan such as a roaster or griddle, or allow cooking utensils to boil dry. The bottom surface of the pan in either of these situations could cause discoloring or cracking of the glass range surface.

Wire trivets: Do not use wire trivets. Cookware bottoms must be in direct contact with the surface elements.

DO NOT use a wok if it is equipped with a metal ring. Because this ring traps heat, the cooktop surface could be damaged.

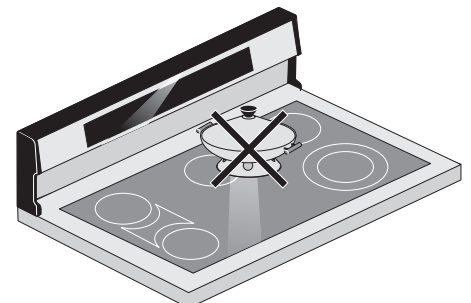

For glass smoothtop models, only flat bottomed woks (without support rings) may be used.

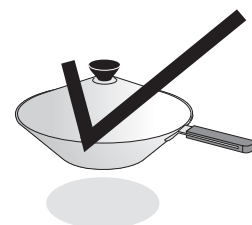

Canning Tips & Information

⚠ CAUTION Canning can generate large amounts of steam. Use extreme caution to prevent burns. Always raise the lid to vent steam away from you.



1. Use tested recipes and follow instructions carefully. Check with the manufacturer of glass jars for the latest canning information.
2. Use flat-bottomed canners only. Heat is spread more evenly when the bottom surface is flat.
3. Center canner on the burner grate.
4. Start with hot water and a high heat setting to reduce the time it takes to bring the water to a boil; then reduce the heat setting as low as possible to maintain a constant boil.
5. It is best to can small amounts and light loads.

⚠ CAUTION Prevent damage to cooktop:

1. Do not use water bath or pressure canners that extend more than one inch beyond the edge of the burner grate.
2. Do not leave water bath or pressure canners on high heat for an extended amount of time.
3. Alternate surface units between each batch to allow the units and surrounding surfaces to cool down. Try to avoid canning on the same burner unit all day.

⚠ CAUTION

Safe canning requires that harmful micro-organisms are destroyed and the jars are sealed completely. When canning in a water bath canner, a gentle but steady boil must be maintained continuously for the required time.

Setting Surface Controls

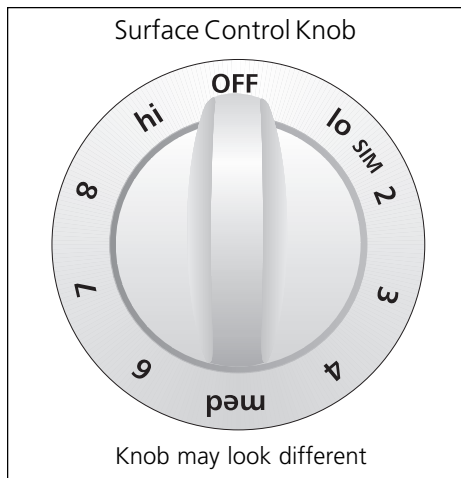

To Operate the Surface Element

1. Place cooking utensil on the surface element.
2. Push in and turn the Surface Control knob in either direction to the desired setting. Start most cooking operations on a higher setting and then turn to a lower setting to finish cooking. The control knobs do not have to be set exactly on a particular mark. Use the marks as a guide and adjust the control knob as needed.
3. When cooking is completed, turn the surface element off before removing the pan. Note: The surface signal light will glow when one or more elements are turned on. A quick glance at the signal light when cooking is finished is an easy check to be sure all control knobs are turned off.

Note: The size and type of utensil used, and the amount and type of food being cooked will influence the setting needed for best cooking results.

Setting	Type of cooking
Max (HI)	Start most foods, bring water to a boil, pan broiling.
Medium High (6)	Continue a rapid boil, fry, deep fat fry.
Medium (5)	Maintain a slow boil, thicken sauces and gravies, steam vegetables.
Medium Low (2-3)	Keep food cooking, poach, stew.
Simmer (SIM)	Keep warm, melt, simmer.

⚠ CAUTION Do not place items such as salt and pepper shakers, spoon holders or plastic wrappings on top of the cooktop when it is in use. These items could melt or ignite. Potholders, towels or wood could catch fire if placed too close to the element.

*The suggested settings found in the chart above are based on cooking in medium thickness aluminum pans with lids. Settings may vary when using other types of pans.

Setting Surface Controls (continued)

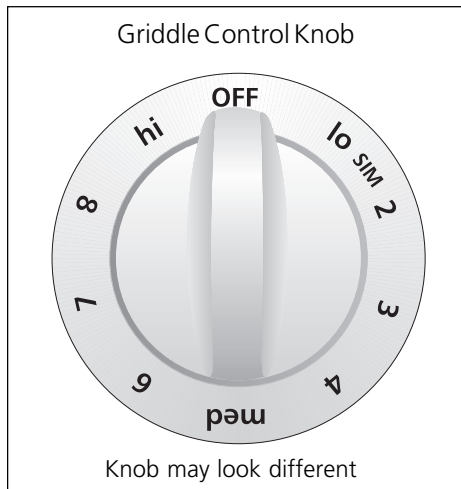

To Operate the Griddle (If equipped)

Foods can be placed directly on the griddle for cooking. To remove the griddle for cleaning the burner box underneath, grasp the griddle in the front and gently pull away from plug terminal, then lift up and out. To reinstall, grasp the griddle with both hands at the end opposite the terminals and using the middle rod at the terminal end as a guide, push the griddle into place.

1. Push in and turn the griddle control in either direction to the desired setting. Start most cooking operations on a higher setting; then turn to a lower setting to finish cooking.
2. The control does not have to be set exactly on a particular mark. Use the marks as a guide and adjust the control as needed.
3. The *griddle indicator light* glows when the griddle is on. A quick glance at the light when cooking is finished is an easy check to be sure the control is turned off.
4. Preheat for a few minutes (until butter melts or beads of water dance on the griddle).
5. Use only nylon or plastic spatulas, spoons, etc. Metal can scratch the non-stick finish.
6. Make sure the griddle is turned OFF when cooking is finished. Leaving the griddle ON will damage it.

Approximate Griddle Settings

Bacon	HI
Grilled Sandwiches	HI
Pancakes	HI
Hamburgers	MED-HI
Eggs	MED

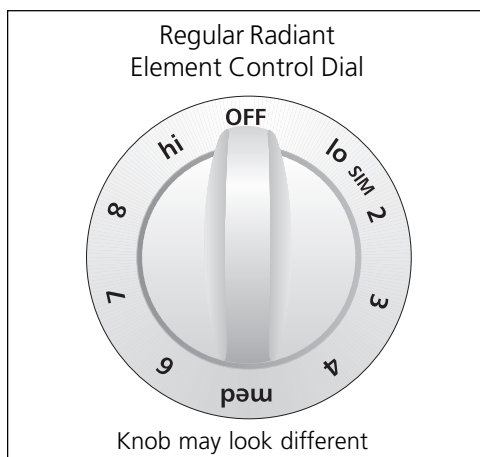

Ceramic Glass Cooktop (some models)

The ceramic-glass cooktop has electric heating coils located below the ceramic glass surface. The design of the glass cooktop outlines the area of the surface heating unit below. Most importantly, make sure the diameter of the pan matches the diameter of the surface unit. Heat is transferred up through the surface of the cooktop. Only flat-bottomed pans should be used. The type and size of cookware, number of surface units in use and the settings of the surface units are factors that will affect the amount of the heat that will spread to areas surrounding the units. The areas surrounding the units may become hot enough to cause burns.

The cooktop should not be used as a cutting board or work surface. Dropping heavy or hard objects on the cooktop may crack it. Pans with rough bottoms may scratch the cooktop surface. Placing foods directly on the smoothtop surface (without utensils) is not recommended as difficult cleaning will result and foods may smoke and cause a potential fire hazard. Never use the griddle or similar cooking sheet on the ceramic glass cooktop.

Note: Due to the high intensity of heat generated by the surface elements, the glass surface will turn green when the element will be turned off. This phenomenon is normal and the glass will come back to its original white color after it has completely cooled down. (White glass cooktops only).

Types of Heating Units Used

REGULAR RADIANT HEATING UNITS (some models)

The ceramic glass design shows the location of the heating surfaces. Control knobs are used to set the heat power levels. Knobs need first to be pressed in when at OFF position, then turned to the desired heat settings.

A glowing red surface extending beyond the bottom edge of the cooking utensil indicates the utensil is too small for the unit. The control knob does not have to be set exactly on a particular mark. Use the marks as a guide and adjust the control knob as needed. The hot surface and surface indicator lights will glow.

Note: A built-in protector will automatically turn off the radiant and expandable radiant element if the ceramic-glass temperature exceeds the set limit.

Setting Surface Controls (continued)

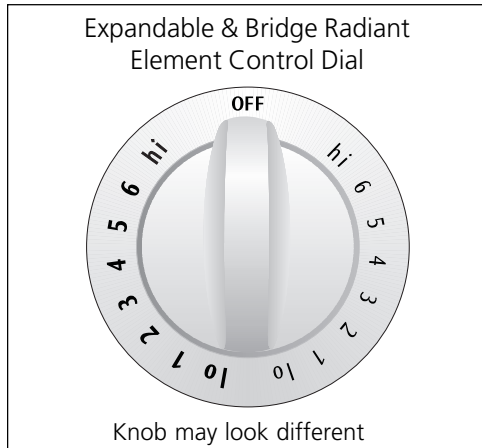

Ceramic Glass Cooktop (some models) (continued)

EXPANDABLE RADIANT HEATING UNITS (some models)

This heating unit adapts to both small and large heating utensils. The unit control dial has a dual set of graduations. For small utensils use the left side of the control dial; for large utensils the right. Only the inner surface of the unit heats when using it for small utensils; the whole surface heats for large utensils. The hot surface and surface indicator lights will glow when the heating unit is turned ON.

Note: During any heat setting of the outer radiant element, the inner radiant element cycles on and off with the outer element.

BRIDGE RADIANT HEATING UNITS (some models)

Its principal advantage is to allow you to create larger cooking zone for larger pan suchs as roaster, griddle or some other specialty pans.

To use the bridge element, turn the control knob on right side, to the bridge burner graduations.

For full bridge element operation turn on the left rear burner.

To use only the front element, turn the control knob on left side, to the front burner graduations.

Indicator Lights (for models with Ceramic Glass Cooktop)

Two different surface control lights will glow on your range: **Surface Indicator Lights** and **Hot Surface Indicator Lights**.

- **The surface indicator lights, located on the control panel,** glow when any surface unit is turned on. A quick glance at the lights after cooking is an easy check to be sure all surface controls are turned off.
- **The hot surface indicators lights, located under the glass cooktop,** will come on as the surface cooking area heats up and will continue to glow until the glass cooktop has cooled down to a moderate level. The lights may remain on even though the controls are turned to OFF.

To Operate the Warmer (Warm & Ready™) Zone (some models)

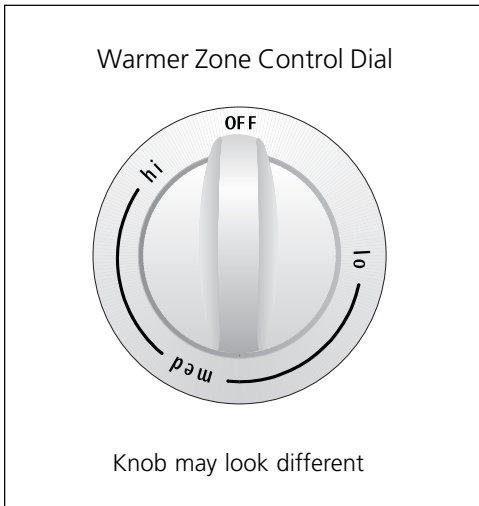

Warmer Zone Recommended Food Settings

Food Item	Heating Level
Breads/Pastries	LO
Casseroles	LO
Dinner Plates with Food	LO
Eggs	LO
Gravies	LO
Meats	MED
Sauces	MED
Soups (cream)	MED
Stews	MED
Vegetables	MED
Fried Foods	HI
Hot Beverages	HI

The purpose of the warmer zone is to keep hot cooked foods at serving temperature. Use the warmer zone to keep cooked foods hot such as: vegetables, gravies, casseroles, soups, stews, breads, pastries and oven-safe dinner plates. Always start with hot food. Do not heat cold food on the warmer zone.

All food placed on the warmer zone should be covered with a lid or aluminum foil. When warming pastries or breads, the cover should have an opening to allow moisture to escape. **Do not use plastic wrap to cover food. Plastic may melt onto the surface and be very difficult to clean.**

Use only dishware, utensils and cookware recommended for oven and cooktop use on the warmer zone.

CAUTION Always use potholders or oven mitts when removing food from the warmer zone as cookware and plates will be hot.

To Set the Warmer Zone Control

1. To set the control, push in and turn the knob. The temperatures are approximate, and are designated by HI, MED and LO. However, the control can be set at any position between HI and LO for different levels of heating.
2. When done, turn the control to OFF. The warmer zone will remain warm until the **hot surface indicator light** goes off.

Temperature Selection

Refer to the chart for recommended heating levels. If a particular food is not listed, start with the medium level, and adjust as needed. Most foods can be kept at serving temperatures by using the medium level.

Indicator Lights

The **surface indicator light** is located below the warmer zone control. It turns on when the control is set, and stays on until the control is turned off. The **hot surface indicator light**, located on the control panel, will come on when the control is set and will continue to glow until the glass cooktop has cooled down to a moderate level.

CAUTION The warmer zone will not glow red when it is hot, but becomes hot enough to cause burns. Avoid placing hands on or near the warmer zone until the hot surface indicator light is off.

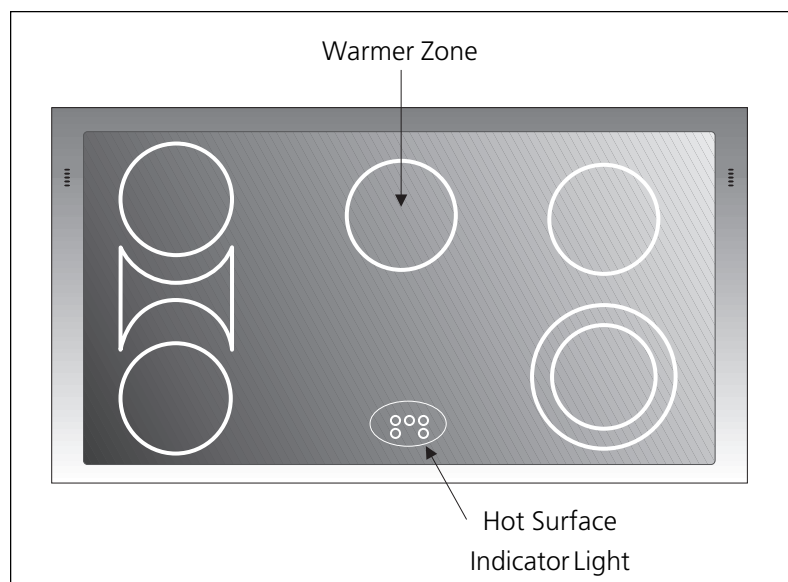

Oven Vent(s) and Racks

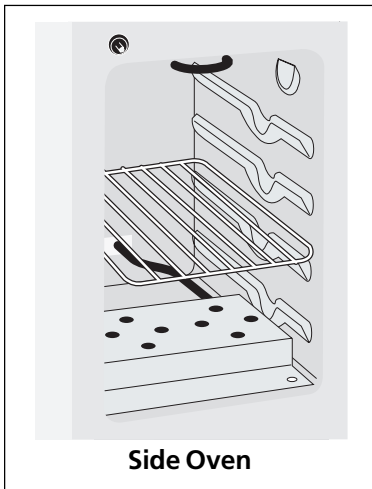
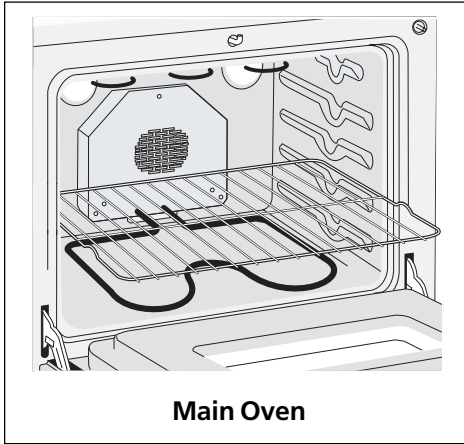

Ovens Vents Locations For Ceramic Glass Cooktops Models :

Each oven has its own vent located on the top, near each side and towards the back of the cooktop. When an oven is on, warm air is released through the vent; this ventilation is necessary for proper air circulation in the oven and good baking results.

Ovens Vents Locations For Coil Elements Models :

The oven is vented through the **center of the left rear** element for the left oven and the **center of the right rear** element for the right oven. When an oven is on, warm air is released through the vent. This venting is necessary for proper air circulation in the oven and good baking results.

Arranging Oven Racks

The smaller oven has one oven rack and the larger oven has two oven racks. *ALWAYS ARRANGE OVEN RACKS WHEN THE OVEN IS COOL (PRIOR TO OPERATING THE OVEN).* Always use oven mitts when using the oven.

To remove an oven rack, pull the rack forward until it stops. Lift up front of rack and slide out.

To replace an oven rack, fit the rack onto the guides on the oven walls. Tilt the front of the rack upward and slide the rack back into place.

Air Circulation in the Oven

If using multiple pans, stagger as shown. If using one pan, place in center of oven.

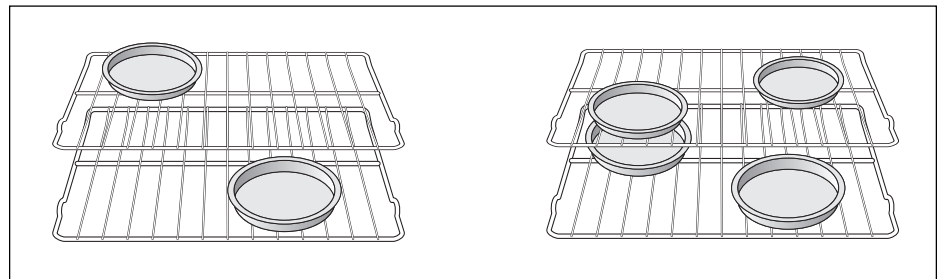

For best air circulation and baking results, center pans as much as possible. Allow 2-4" (5-10 cm) around the utensil(s) for proper air circulation and be sure pans do not touch each other or the door, sides and back of oven. The hot air must circulate around the pans in the oven for even heat to reach all parts of the oven.



Oven Baking Informa- tions

For best results, preheat the oven before baking cookies, breads, cakes, pies or pastries, etc. There is no need to preheat the oven for roasting meat or baking casseroles.

The cooking times and temperatures needed to bake a product may vary slightly from your previously owned appliance.

See step-by-step baking instructions for right oven in the Electronic Oven Control section.

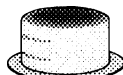
See left oven step-by-step instructions in the "Setting Left Oven Control" section.

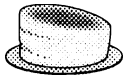
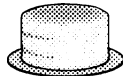
Baking problems and solutions		
Baking Problems	Causes	Corrections
<p>Cookies and biscuits burn on the bottom.</p> 	<ul style="list-style-type: none"> • Cookies and biscuits put into the oven before the pre-heating time is completed. • Oven rack overcrowded. • Dark pan absorbs heat too fast. 	<ul style="list-style-type: none"> • Allow oven to preheat to the selected temperature before placing food in oven. • Choose pan sizes that will permit 5.1 cm to 10.2 cm (2" to 4") of air space on all sides when placed in the oven. • Use a medium-weight aluminum baking sheet.
<p>Cakes too dark on top or bottom.</p> 	<ul style="list-style-type: none"> • Cakes put into the oven before preheating time is completed. • Oven rack position too high or low. • Oven too hot. 	<ul style="list-style-type: none"> • Allow oven to preheat to the selected temperature before placing food in the oven. • Use proper rack position for baking needs. • Set oven temperature 25°F/12°C lower than recommended.
<p>Cakes not done in the center.</p> 	<ul style="list-style-type: none"> • Oven too hot. • Incorrect pan size. • Pan not centered in the oven. 	<ul style="list-style-type: none"> • Set oven temperature 25°F/12°C lower than recommended. • Use pan size suggested in recipe. • Use proper rack position and place pan so there is 5.1 cm to 10.2 cm (2" to 4") of space on all sides of pan.
<p>Cakes not level.</p> 	<ul style="list-style-type: none"> • Range not level. • Pan too close to oven wall or rack overcrowded. • Pan warped. 	<ul style="list-style-type: none"> • Place marked glass measuring cup filled with water on the center of the oven rack. If water level is uneven, refer to the installation instructions for leveling the appliance. • Be sure to allow 5.1 cm to 10.2 cm (2" to 4") of clearance on all sides of each pan in the oven. • Do not use pans that are dented or warped.
<p>Foods not done when cooking time is up.</p> 	<ul style="list-style-type: none"> • Oven too cool. • Oven overcrowded. • Oven door opened too frequently. 	<ul style="list-style-type: none"> • Set oven temperature 25°F /12°C higher than suggested and bake for the recommended time. • Be sure to remove all pans from the oven except the ones to be used for baking. • Open oven door only after shortest recommended baking time.

Broiling Informations

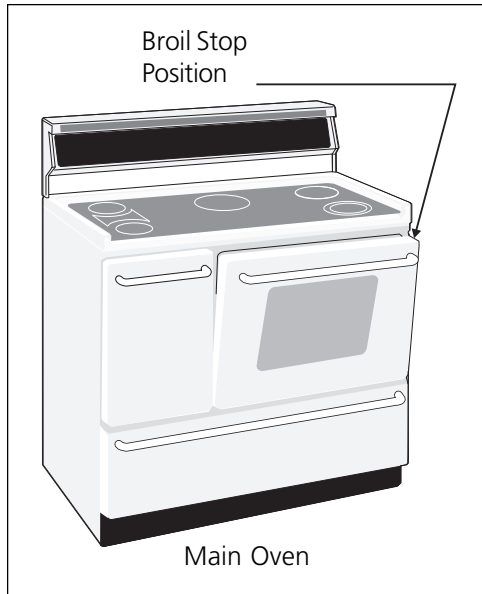

Broiling is a method of cooking tender cuts of meat by direct heat from the broil element of the oven. Meats are placed on the broiling rack and the rack is placed under the broiling element.

See the broiling instructions for main oven in the [Setting Oven Controls](#) section in the [Timer Guide](#).

See side oven step-by-step instructions in the [Setting Side Oven Control](#) section.

Preheating

Preheating is suggested when searing rare steaks (remove the broiler pan before preheating; food will stick if placed on hot metal.) To preheat, set the oven control(s) to BROIL. Wait for the element to become red-hot, usually about 2 minutes. Preheating is not necessary when broiling meats well-done.

To Broil

Broil on one side until the food is browned; turn and cook on the other side; season and serve. Always pull rack out to the stop position before turning or removing food.

Determining Broiling Times

Broiling times vary; watch the food closely. Time not only depends on the distance from the element, but on the thickness and age of meat, fat content and doneness preferred. The first side usually requires a few minutes longer than the second. Frozen meats also require additional time.

Broiling Tips

The broiler pan and its grid allow dripping grease to drain and be kept away from the high heat of the broiler.

DO NOT use the pan without its grid. DO NOT cover the grid with foil. The exposed grease could ignite.

⚠ CAUTION Should an oven fire occur, close the oven door and turn off the oven. If the fire continues, throw baking soda on the fire or use a fire extinguisher. **DO NOT put water or flour on the fire.** Flour may be explosive.

Always pull oven rack out to the stop position before turning or removing food.

Broiler Clean-Up Tips:

- To make cleaning easier, line bottom of the broiler pan with aluminum foil. DO NOT cover the broiler grid with foil.
- To prevent grease from baking on, remove the broiler pan from the oven as soon as cooking is completed. Use hot pads because the broiler pan is extremely hot. Pour off grease. Soak the pan in HOT, soapy water.
- Clean the broiler pan as soon as possible after each use. If necessary, use soap-filled steel wool pads. Heavy scouring may scratch the grid.

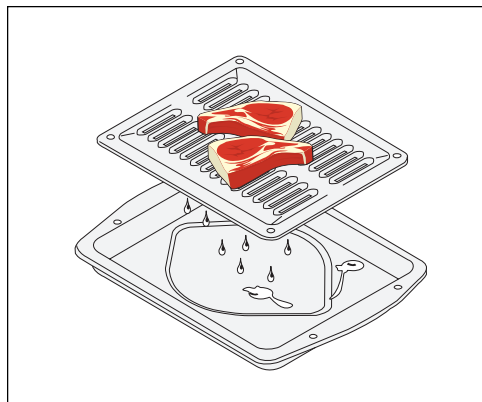

Convection Cooking and Baking (If equipped)

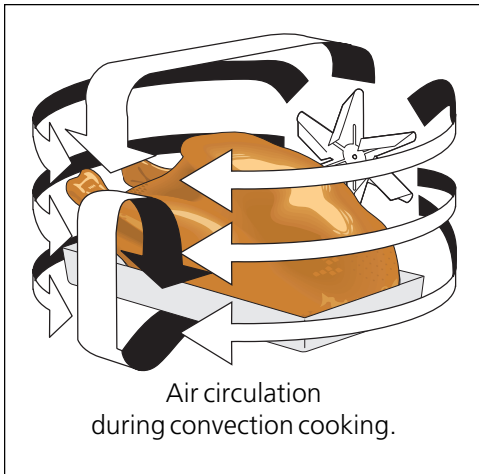

To select convection cooking mode, press CONV BAKE ROAST button on control panel before setting cooking temperature and time.

The convection option, available on some models, is an alternative to the conventional oven cooking methods of baking/roasting.

Convection cooking is a method of cooking in which the heated air of the oven is circulated by a fan at the rear of the oven cavity, providing better heat distribution. This fan is covered by a baffle to circulate the air uniformly, providing even heat distribution for faster and more even cooking, baking and browning. The heated air penetrates food from every angle, sealing in natural moisture and flavors. **The convection fan automatically turns off when the oven door is opened and resumes when the door is closed again.** However, the heating element will stay on.

The oven can be programmed to bake in the convection mode at any temperature from 170°F/80°C to 550°F/288°C. Preheating the oven for 10-12 minutes is recommended when using convection but not necessary when roasting or cooking casseroles.

CAUTION: In the convection mode, using cooking times from conventional cooking recipes may cause food to be **overcooked**. For satisfactory results, use only tested recipes with times adjusted for convection cooking. Obtaining and using a convection oven cookbook is highly recommended.

Convection cooking uses a **lower temperature** and takes **less time** to achieve the same results as conventional cooking. In convection mode, the actual temperature in your oven automatically adjusts to be 25°F/12°C lower than the temperature displayed on the oven control panel. Because of this automatic adjustment you can enter the cooking temperature from your existing conventional cooking recipe, but **do not** set the cooking time to be the same. Even at the lower cooking temperature, convection cooking times will be as much as 30% less than conventional cooking times.

When programming cooking times for convection cooking, enter a time that is 20 to 30 percent less than called for in your conventional cooking recipe. After the cooking cycle ends, decide if the food is done to satisfaction, slightly overdone or slightly underdone (if underdone, cook a short time longer to satisfaction). Make a note of the time and results, and with your next use of the recipe adjust cooking time accordingly.

Convection Roasting (If equipped)

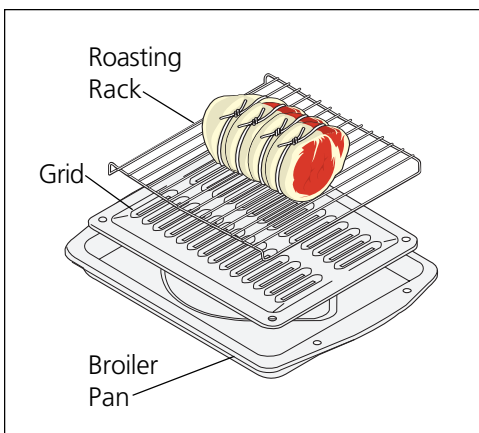

When convection roasting, use the broiler pan and grid, and the roasting rack. The broiler pan will catch grease spills and the grid will help prevent grease spatters. The roasting rack will hold the meat.

1. Place oven rack on bottom or next to bottom rack position.
2. Place the grid in the broiler pan. The roasting rack fits on the grid allowing the heated air to circulate under the food for even cooking and helps to increase browning on the underside. Make sure the roasting rack is securely seated on the grid in the broiler pan. **DO NOT** use broiler pan without the grid. **DO NOT** cover the grid with aluminum foil.

Setting Side Oven Control (left oven, if equipped)

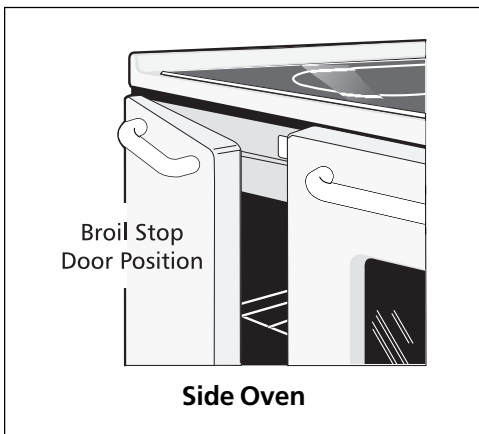
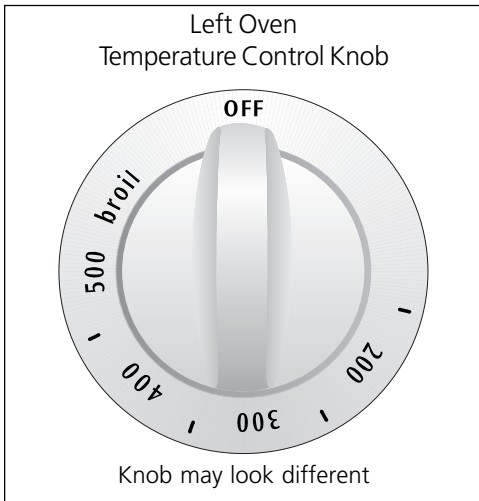

The broiler pan and its grid allow dripping grease to drain and be kept away from the high heat of the broiler. **DO NOT** use the pan without its grid. **DO NOT** cover the grid with foil. The exposed grease could ignite.

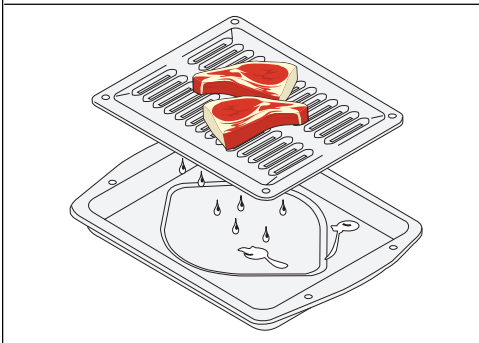

To Bake

1. Arrange oven racks while the oven is still cool.
2. Turn the Temperature Control Knob to the desired oven temperature. When the oven is first turned on, the oven indicator light below the Temperature Control Knob will glow.
3. Preheat the oven for 10 to 12 minutes before baking. Preheating is not necessary when roasting, cooking casseroles or broiling most foods. When the desired temperature is reached, the oven indicator light will go out. The light will then go on and off as the element cycles on and off to maintain the desired temperature.
4. When cooking is finished, turn the Temperature Control Knob to OFF.

To Broil

1. Arrange oven rack while oven is still cool. For rare meats, position the broiler pan closer to the element (upper position). For well-done foods such as chicken, lobster tails or thick cuts of meat, position the pan further from the element (to a lower position).

Rack Position From Top	Food
1	Rare steaks.
2	Hamslices, fish, hamburgers and medium steaks and chops.
3	Well-done foods such as chicken and lobster.

2. Turn the Temperature Control Knob to BROIL. To sear rare steaks, allow the element to become red-hot—about 2 minutes—before placing food in oven.
3. Place the grid on the left oven broiler pan, and then place the meat on the grid. **DO NOT** use the broiler pan without the grid or cover the grid with aluminum foil. The exposed fat could ignite.
4. Place the pan on the oven rack. **Close the oven door to the Broil Stop position while broiling (door opened about 2 inches).**
5. Broil on one side until food is browned; turn and cook on the other side. Season and serve. **Note:** Always pull the rack out to the stop position before turning or removing food.
6. When broiling is finished, turn the Temperature Control Knob to OFF.

CAUTION Should an oven fire occur, close the oven door and turn off the oven. If the fire continues, throw baking soda on the fire or use a fire extinguisher. **DO NOT put water or flour on the fire. Flour may be explosive.**

Self-Clean Oven Cycle

(Main Oven)

CAUTION The health of some birds is extremely sensitive to the fumes given off during the self-cleaning cycle of any range. Move birds to another well ventilated room.

CAUTION During the self-clean cycle, the outside of the wall can become very hot to touch. **DO NOT** leave small children unattended near the appliance. A ventilation system starts automatically; it is normal for the hot air to be evacuated through the front of the appliance.

CAUTION Before cleaning any part of the oven, be sure the electronic oven control is turned off or else push **CANCEL** pad. Wait until the oven is cool.

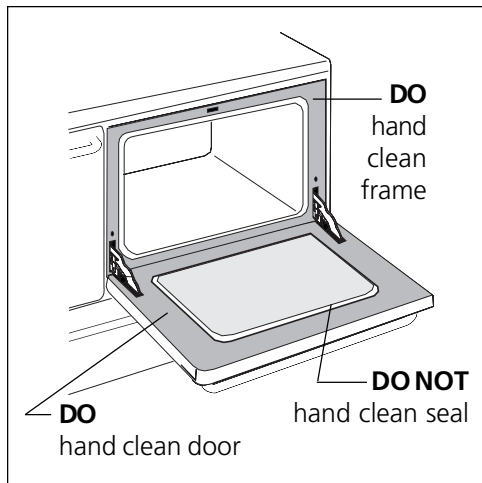

Adhere to the Following Precautions:

- Allow the oven to cool before cleaning.
- Wear rubber gloves when cleaning any exterior parts of the oven manually.

DO NOT use commercial oven cleaners or oven protective coatings in or around any part of the self-cleaning oven. **DO NOT** clean the oven door gasket. The gasket on the oven door is essential for a good seal. Care should be taken not to rub, damage or move the gasket. **DO NOT** use aluminum foil to line the oven bottom. This may affect cooking, or the foil could melt and damage the oven surface.

A self-cleaning oven cleans itself with high temperatures (well above cooking temperatures) which eliminate soil completely or reduce it to a fine powdered ash you can wash away with damp cloth.

Preparing for the Self-Cleaning Cycle

1. Remove excess spillovers in the oven cavity before starting the self-clean cycle. To clean, use hot soapy water and a cloth. Large spillovers can cause heavy smoke or fire when subjected to high temperatures. **DO NOT** allow food spills with a high sugar or acid content (such as tomatoes, sauerkraut, fruit juices or pie filling) to remain on the surface as they may cause a dull spot even after cleaning.
2. Clean all soil from the oven frame and the inner door (see illustration to right). These areas heat sufficiently during self-cleaning cycle to burn soil on. Clean with soap and water. Do not clean door seal because doing so can permanently damage it.
3. Remove the broiler pan and insert all utensils and any foil. These items do not withstand high cleaning temperatures.
4. Oven racks may be left in the oven or may be removed. If they go through the clean cycle, their color will turn slightly dull. After the cycle is completed and the oven has cooled, rub the sides or the racks with wax paper or a cloth containing a small amount of baby oil or salad oil. This will make the racks glide easier.

What to Expect During Cleaning

While the oven self-cleans, it heats to temperatures much higher than those used in normal cooking. Sounds of metal expansion and contraction are normal. Odor is also normal as the food soil is being removed. Smoke may appear through the oven vent, located on both sides of cooking surface.

If heavy spillovers are not wiped up before cleaning, they may flame and cause more smoke and odor than usual. This is normal and safe and should not cause alarm. If available, use an exhaust fan during the self-cleaning cycle.

NOTE: When the oven reaches its self-clean temperature, the smoke level will be reduced to vapor.

CAUTION **DO NOT** force the oven door open. This can damage the automatic door locking system. Use caution when opening the door after the self-cleaning cycle is completed. The oven may still be **VERY HOT**.

Porcelain Enamel Oven Cleaning (Side Oven) (if equipped)

Adhere to the following cleaning precautions:

- Allow the oven to cool before cleaning.
- Wear rubber gloves when cleaning the appliance manually.

Remove spillovers and heavy soils as soon as possible. Regular cleanings will reduce the number of future major cleanings.

⚠ CAUTION Ammonia must be rinsed before operating the oven. Provide adequate ventilation.

Porcelain has a smooth finish and is a type of glass fused to metal. Oven cleaners can be used on all interior oven surfaces.

General Cleaning

Remove soils using hot, soapy water. Do not allow food spills with a high sugar or acid content (such as milk, tomatoes, sauerkraut, fruit juices or pie filling) to remain on the surface as they may cause a dull spot even after cleaning.

To Remove Heavy Soil

1. Allow a dish of ammonia to sit in the oven overnight or for several hours with the oven door closed. Clean softened spots using hot, soapy water. Rinse well with water and a clean cloth.
2. If soil remains, use a soap-filled scouring pad or a nonabrasive cleaner. If necessary, use an oven cleaner following manufacturer's instructions. **DO NOT** mix ammonia with other cleaners.

Adhere to the following precautions when using oven cleaners:

1. **DO NOT** spray on the electrical controls or switches because it could cause a short circuit and result in sparking or fire.
2. **DO NOT** allow a film from the cleaner to build up on the temperature sensing bulb located at the top left rear corner of the oven; it could cause the oven to heat improperly. Carefully wipe the bulb clean after each oven cleaning, being careful not to move the bulb. A change in its position could affect how the oven bakes. Avoid bending the bulb and capillary tube.
3. **DO NOT** spray any cleaner on the oven door trim or gasket, handles or any exterior surfaces of the range, wood or painted surfaces. The cleaner can damage these surfaces.

To Clean the Oven Bottom

Clean using hot, soapy water, a mild abrasive cleanser, a soap-filled abrasive pad or oven cleaner following oven cleaner manufacturer's instructions.

⚠ CAUTION DO NOT line the oven walls, bottom, racks or any other part of the appliance with aluminum foil. Doing so will destroy heat distribution, produce poor baking results and cause permanent damage to the oven interior (aluminum foil will melt to the interior surface of the oven).

To Clean the Cooktop Glass

THIS COOKTOP IS NOT REMOVABLE.
Do not attempt to remove or lift the cooktop.



⚠ WARNING DO NOT use a cooktop cleaner on a hot cooktop. The fumes can be hazardous to your health, and can chemically damage the ceramic-glass surface. Be sure the controls are turned to **OFF**. Do not use commercial oven cleaners on any part of the cooktop. Damage to the finish or parts could result.

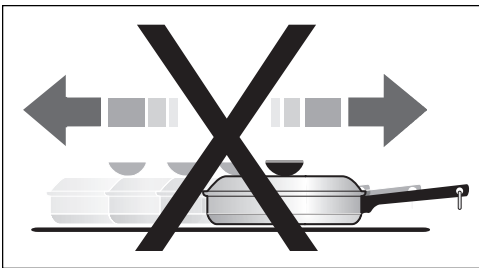

The cooktop is designed to make cleaning easier. Cleanups are easy when spills are cleaned up immediately. To clean, wipe with a clean, damp cloth and wipe dry.

Correct and consistent leaning is essential to maintaining your heat-resistant glass top. Spills and splatters should be wiped up using a clean paper towel and sudsy water. This should be done either as soon as possible after the spill occurs, after cooking is completed, or at the latest, before using the cooktop again. Use caution if the cooktop is hot. For heavy spills, spatter or burned-on materials, use a razor blade scraper. Hold the razor blade scraper at no more than a 30° angle and remove food spills or burned on food residue.

Finish the cleaning process by applying a recommended heat-resistant glass cooktop cleaning cream. Apply cleaner with clean, damp paper towel. Rinse with a paper towel dampened with clean water and wipe dry. Always wipe the cooktop thoroughly to avoid heating any cleaner residue.

Special Caution for Aluminum Foil and Aluminum Cooking Utensils

1) Aluminum foil

Use of aluminum foil will damage the cooktop. Do not use under any circumstances.

2) Aluminum utensils

The melting point of aluminum being much lower than that of other metals, care must be taken when aluminum pots or pans are used. If allowed to boil dry, not only will the utensil be ruined, but also permanent damage in the form of breakage, fusing or marking may affect the ceramic glass surface.

Things to Remember

1. **Do not slide utensils across cooktop surface in any circumstance, doing so may scratch or metalmark the cooktop surface.**
2. AVOID using bleach and don't use ammonia to clean the ceramic surface.
3. Do not put plastic items on warm cooking areas.
4. Never slide oven racks across cooktop surface. They may scratch or metalmark the cooktop.
5. **If cooktop should break, do not use cooktop or attempt to clean it. Call your authorized service technician immediately.**
6. Never use a trivet or metal stand between the cooking utensil and the ceramic cooktop. The ceramic surface may be scratched, metal marked or etched by such items.
7. Sugary spills can cause pitting of your cooktop surface. Therefore, you must begin cleaning the spills while the cooktop is still hot. Use caution when following the steps below.
 - a) Turn off all surface units and remove all pans immediately.
 - b) Wearing an oven mitt, use a razor blade scraper to scrape the hot spill out of the cooking zone to a cooler area on the cooktop.
 - c) Allow the cooktop to cool.

Use and Care of Glass Surface

Problem	Cause	To Prevent	To Remove
Fine "brown lines" (tiny scratches or abrasions which have collected soil).	Coarse particles (salt, sand, sugar or grit) between bottom of cookware and cooktop that are not removed before cooking. Using incorrect cleaning materials.	Clean cooktop after every use. Daily use of cleaner cream.	Tiny scratches are not removable. They can be minimized by continual use of cleaner cream. Such scratches do not affect cooking.
Metal marking (mark or black marks).	Sliding or scraping metal utensils or oven shelves across cooktop.	Do not slide cookware across cooktop.	Apply cleaner cream with dampened paper towel to a cooled surface.
Brown streaks and specks.	Cleaning with a sponge or dishcloth that has been used for other kitchen tasks.	Use cleaner cream cloth with clean, damp paper towel.	Use a small amount of cleaner cream with clean, damp paper towel.

To Clean the Cooktop Glass (continued)

⚠ CAUTION Do not use cleaners on a heated surface. Fumes could be hazardous. Wait for area to cool before cleaning. Do not use cleaner cream to clean porcelain, paint or aluminum because it can damage the surface.

Cleaning Materials for Ceramic-Glass Cooktop

Some cleaning materials may contain an ingredient which can damage the cooktop. Use recommended cleaning products only (see below). Cleaner cream should be used regularly. First use recommended products listed below, then use cleaner cream.

Use only recommended cleaning products and follow these basic cleaning suggestions.

1. Before the cooktop is used, thoroughly clean and saturate the cooktop with cleaner cream.
 - a) Dampen clean paper towel and clean unit.
 - b) Wipe off with another clean, damp paper towel; then wipe dry.
2. For normal daily cleaning, apply a dab of cleaner cream in the center of each unit-area to be cleaned. Start with approximately 1/8 teaspoon (apply more if needed). Then, proceed as stated above in a and b.
3. Make sure bottom of cookware and cooking area are clean and dry.
4. Select heat settings and cookware large enough for food and liquid.
5. Wipe up food spills and spatters before they burn into surface.

IMPORTANT: Regularly use cleaner cream. If you run out of cream, use one of the cleaners listed. Be sure to get a new supply of cleaner cream.

⚠ CAUTION Never mix cleaning products! Mixtures may interact, with damaging or hazardous results.

Recommended cleaning products for ceramic-glass cooktop

1. Baking soda.
2. Non-impregnated plastic and nylon pads.
3. For burned on material, scrape with single-edged razor blade, held at a 30° angle.
4. Ceramic glass cleaning cream.

Do not use on ceramic-glass cooktop

1. Avoid pads, that can leave marks and scratches.
2. Avoid heavy-duty cleaning powders; these can scratch, depending on their abrasiveness and cleaning pressure applied.
3. Avoid chemical oven cleaners. These can etch the cooktop surface and are caustic.
4. Avoid rust stain removers containing hydrofluoric acid.
5. Avoid using bleach and do not use ammonia.

Special Cleaning Instructions for Mineral Deposits and Discolorations

Problem: Condensation, when cooking, often collects and drips from cookware. The minerals found in water may cause a gray or brown film to develop on cooktop. This film is very thin and appears to be under cooktop.



Prevention: Daily and proper use of cleaner cream. Stain from mineral deposits must be removed from the cooktop as soon as possible.

Removal:

- Wet surface with water and apply cleaner cream.
- Scrub with clean, damp paper towel until stain disappears.
- Clean remaining paste away with damp paper towel.
- Apply dab of cleaner cream and polish with clean paper towel.

Cleaning Various Parts of Your Range

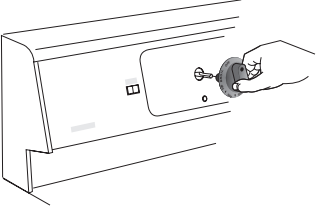
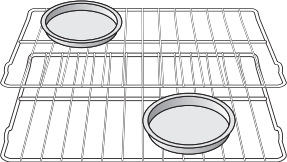
Before cleaning any part of the range, be sure all controls are turned OFF and the range is cool. Remove spillovers and heavy soiling as soon as possible. Regular cleaning will reduce the effort required for major cleaning later.

Surfaces	How to Clean
Vinyl and Aluminum (Trim Pieces)	Use hot, soapy water and a cloth. Dry with a clean cloth.
Control Panel 	<i>Before cleaning the control panel</i> , turn all controls to OFF and remove the control knobs. To remove, pull each knob straight off the shaft. Clean using hot, soapy water and a dishcloth. Be sure to squeeze excess water from the cloth before wiping the panel; especially when wiping around the controls. Excess water in or around the controls may cause damage to the appliance. To replace knobs after cleaning, line up the flat sides of both the knob and the shaft; then push the knob into place.
Stainless Steel Control panel, Oven door and Drawer front panel	Cleaners made especially for stainless steel as Stainless Steel Magic, or other similar cleaners are recommended. Always follow the manufacturer's instructions. Be sure to rinse the cleaners as bluish stains may occur during heating and cannot be removed.
Oven Racks 	Remove racks. See "To remove and to replace an Oven Rack" under Setting Oven Controls . Use a mild, abrasive cleaner, following manufacturer's instructions. Rinse with clean water and dry. After cleaning the racks, rub the sides of the racks with wax paper or a cloth containing a small amount of baby oil or salad oil (this will make the racks glide easier into the rack positions).
Cooktop, under Cooktop, Broiler Pan and Insert, Door Liner, Small Oven	Gentle scouring with a soapy scouring pad will remove most spots. Rinse with a 1:1 solution of clear water and ammonia. <i>If necessary</i> , cover difficult spots with an ammonia-soaked paper towel for 30 to 40 minutes. Rinse with clean water and a damp cloth and then scrub with a soap-filled scouring pad. Rinse and wipe dry with a clean cloth. Remove all cleaners or the porcelain may become damaged during future heating. DO NOT use spray oven cleaners on the cooktop.
Oven Door 	To clean oven door, wash with hot, soapy water and a clean cloth. DO NOT immerse the door in water. DO NOT clean the oven door gasket. The oven door gasket is made of a woven material which is essential for a good seal. Care should be taken not to rub, damage or remove the gasket.
Glass, Paint and Plastic Control Knobs, Body Parts and Decorative Trim	<i>For general cleaning</i> , use hot, soapy water and a cloth. <i>For more difficult soils and built-up grease</i> , apply a liquid detergent directly onto the soil. Leave on soil for 30 to 60 minutes. Rinse with a damp cloth and dry. DO NOT use abrasive cleaners on any of these materials; they can scratch. To remove control knobs, turn to the OFF position; grasp firmly and pull straight off the shaft. To replace knobs after cleaning, line up the flat sides of both the knob and the shaft; then push the knob into place.

Cleaning Various Parts of Your Range (continued)

CAUTION Be sure the range is cool before removing elements or drip bowls. Be careful not to bend terminal ends when replacing elements after cleaning.

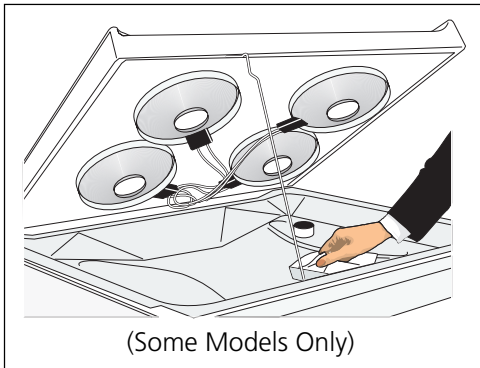
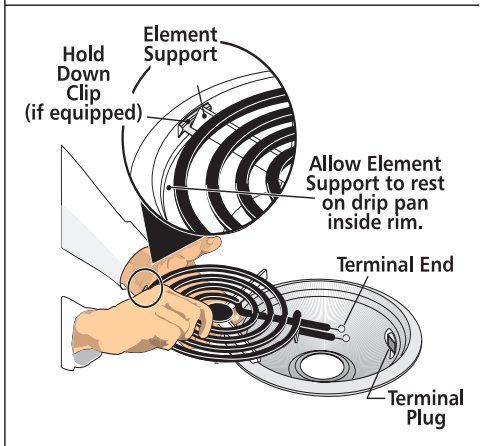

CAUTION When lowering the lift-up range top, grasp the sides with finger-tips only. Be careful not to pinch fingers. **DO NOT** drop or bend the range top when raising or lowering. This could damage the surface.

Surface Elements and Drip Bowls

Surface elements can be unplugged and removed to make cleaning the drip pans easier. The surface elements clean themselves when they are turned on. Food spilled on a hot element will burn off. Food spilled on a cool element may be cleaned with a damp cloth—any remaining soil will burn off the next time the element is used. **Never immerse a surface element in water.**

To Remove the Surface Elements and Drip Bowls

1. Lift up edge of surface element across from terminal end. Lift just enough to clear edge of the drip bowl.
2. Gently slide the surface element out of the terminal plug.
3. Lift the drip bowl up and out.

To Clean Drip Bowls

Wash in hot, soapy water or in the dishwasher. Rinse and dry while still warm. Hard to remove, burned on soil can be removed by soaking the drip bowls for about 20 minutes in a lightly diluted liquid cleanser or a solution of ammonia and water (1/2 cup ammonia to 1 gallon of water). A nylon scrubber may be used after soaking. **DO NOT** use abrasive cleaners or steel wool, as they will scratch the surface. Always rinse with clean water and polish dry with a soft cloth.

To Replace Drip Bowls and Surface Elements

1. Slide the terminal end on the element through the opening in the drip bowl.
2. Align the element support to rest on the rim inside the drip bowl. If your drip bowl is equipped with a hold down clip, align the element support opposite the terminal end with the slot in the hold down clip, and snap into place.
3. After the element is positioned in the drip bowl, line up the terminal end with the terminal plug as shown.
4. Hold the surface element and drip bowl together as level as possible and firmly push the terminal end into the terminal plug. Make sure element terminal is seated properly into terminal plug. Make sure the surface element is level to reduce the hazard of pans sliding off the element.

To Raise the Top for Cleaning (Some Models Only)

1. Grasp the sides and lift from the front. Lift-up rod will support the top in its raised position. Only lift the top high enough to allow the support rod to rest in place under the front of the cooktop.
2. Clean underneath using a clean cloth and hot, soapy water.
3. To lower the top, lift the top slightly and lower the rod. Lower the range top into the range frame.

Cleaning Various Parts of Your Range (continued)

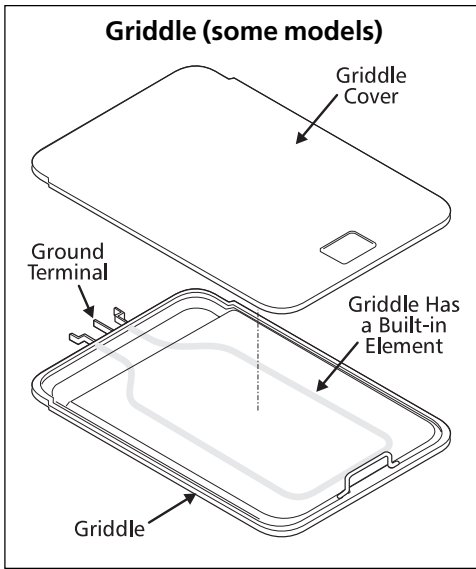

Cleaning the Griddle (some models)

Before cleaning, be sure all controls are OFF. For easier cleaning, clean the griddle while it is still *warm*. The griddle can be removed for easier cleaning. The griddle can be washed in the sink with a mild detergent and plastic scouring pad. For greasy residue, use a grease-dissolving dishwashing liquid and a nylon scrub brush. **DO NOT immerse griddle terminals in water.**

Avoid abrasive cleansers that can scratch the finish. Do not use oven cleaners. Wipe dry before reinstalling into rangetop.

CAUTION Do not use metallic scrubbers to clean the griddle. Metals can scratch the surface. Only use nylon or plastic scrubbers.

Storage Drawer

Use the storage drawer for storing cooking utensils. The drawer can be removed to facilitate cleaning under the range. Use care when handling the drawer.

To Remove the Storage Drawer:

1. Open and empty the drawer of all utensils.
2. Pull drawer out to the drawer stop.
3. Lift the front high enough to allow the drawer to be pulled out.

To Replace the Storage Drawer:

1. Insert the rear end of the drawer into the opening.
2. Fit the end rollers onto the guide rails.
3. Hold the drawer in a horizontal position, then push in until a click is heard.

WARNING Flammable materials should not be stored in an oven, near surface elements or in the storage drawer or compartment (if equipped). This includes paper, plastic and cloth items, such as cookbooks, plasticware and towels, as well as flammable liquids. Do not store explosives, such as aerosol cans, on or near the range. Flammable materials may explode and result in fire or property damage.

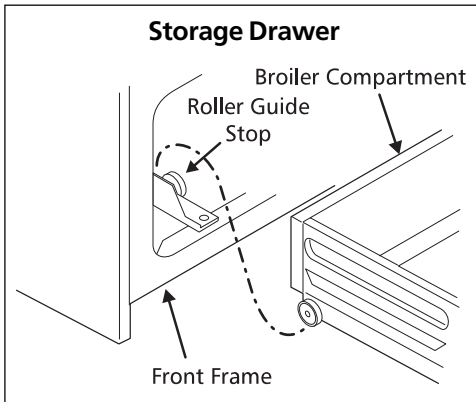

To Remove and Replace Right Oven Door

CAUTION The door is heavy. After removing door, lay it flat on the floor with its inside facing down.

1. Open the door to the fully opened position.
2. Pull up the lock located on both hinge supports and engage it in the hinge levers. You may have to apply a little downward pressure on the door to pull the locks fully over the hooks.
3. Grab the door by the sides, pull the bottom of the door up and toward you to disengage the hinge supports. Keep pulling the bottom of the door toward you while rotating the top of the door toward the range to completely disengage the hinge levers.
4. To replace the door, reverse the door removal steps. Make sure the hinge supports are fully engaged before unlocking the hinge levers.

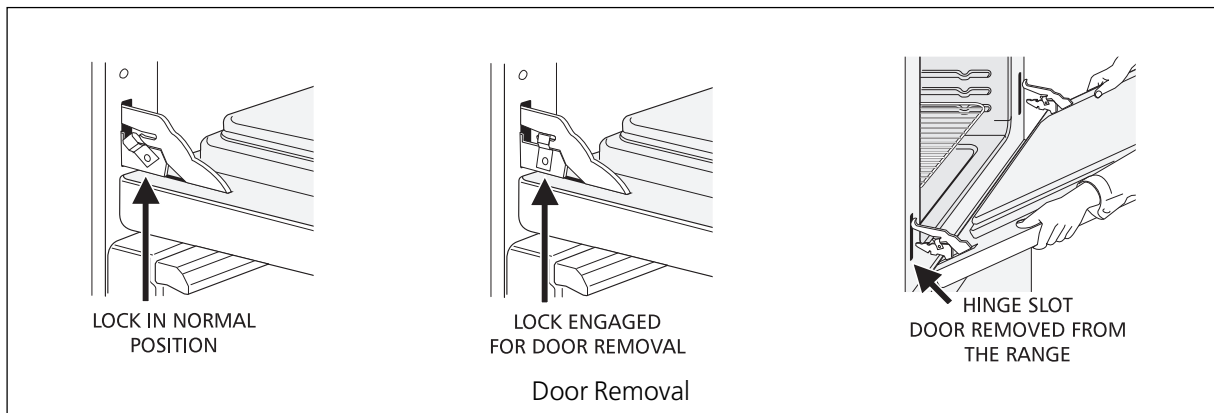

To Remove and Replace Storage Drawer (with extended guides)

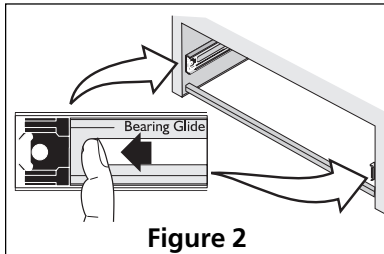
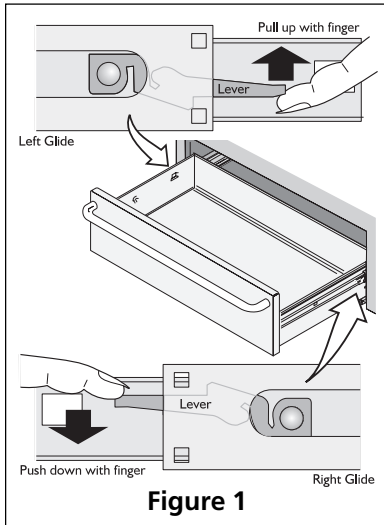

To Remove Storage Drawer:

1. Open the drawer to the fully opened position.
2. Locate the glide lever on each side of drawer; pull up on the left glide lever and push down on the right glide lever (see figure 1).
3. Pull the drawer away from the range.

To Replace Storage Drawer:

1. Pull the bearing glides to the front of the range (see figure 2).
2. Align the drawer glides with the slots on the bearing glides.
3. Push the drawer into the range until the glides levers "click" (approx. 2 in.). Pull the drawer open again to seat it into position.
4. **If you do not hear the glide levers "click" or if the drawer does not feel seated, remove it and repeat steps 1 through 3.** Doing so will minimize damage to the bearing glides. Do not try to force the drawer into place.

Changing Cooktop and/or Oven Lights (some models)

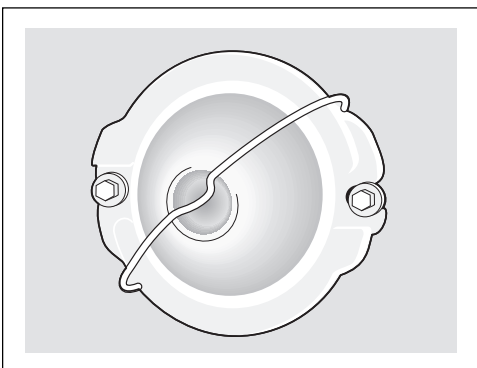
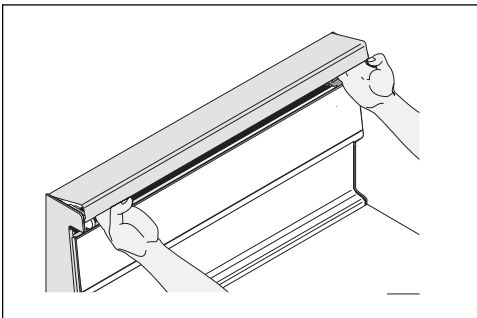

To Change the Cooktop Light (some models)

Your model will either have a canopy cover that lifts up or 2 Phillips® Head screws that secure the light cover. BEFORE CHANGING THE COOKTOP LIGHT, BE SURE TO TURN THE POWER OFF AT THE MAIN SOURCE OR UNPLUG THE RANGE.

For models with a canopy cover that lifts up, follow these instructions:

1. Grasp the front edge of the canopy cover as illustrated in the side column. Pull forward and lift the cover up and off toward rear of range.
2. Remove bulb by rolling up and out. Install the new bulb by sliding down into place and rolling toward front of range.
3. Align front edge of light cover with inside lip of end cap. Lower rear of cover into place and snap down.
4. Turn power back on at the main source (or plug the range back in).

To Change the Oven Light

The oven light automatically turns on when the door is opened (some models). To turn the oven light on and off when the door is closed, use the OVEN LIGHT switch located on the control panel.

1. Turn electrical power off at the main source or unplug the oven.
2. Wear a leather-faced glove for protection against possible broken glass.
3. Press wire holder to one side to release the glass shield.
4. Replace bulb with a new 40 watt appliance bulb.
5. Replace glass shield in socket and snap wire holder into place.
6. Turn power back on at the main source (or plug the appliance back in).
7. The clock will then need to be reset. To reset, see **Setting the Clock and Minute Timer** in the ELECTRONIC OVEN CONTROL manual.

CAUTION Be sure the oven is unplugged and all parts are COOL before replacing the oven light bulb. Do not turn the oven light on during a self-cleaning cycle. High temperature will reduce lamp life.

Avoid Service Checklist

You may save the cost and inconvenience of an unnecessary service call by first reviewing this Checklist of commonly encountered problem situations.

You will be charged for a service call while the appliance is in warranty if the problem is not caused by defective product workmanship or materials.

Your new appliance is a carefully engineered product. Many times, what appears to be a reason to call service requires nothing more than a simple adjustment you can easily make in your own home.

OCCURRENCE

Range is not level.

POSSIBLE CAUSE/SOLUTION

Poor installation. To level range, refer to Leveling Guide, in the Installation Instructions. When range is level, cooktop may appear out of alignment if countertop is not level.

Weak, unstable floor. Be sure floor is level and can adequately support range. Contact a carpenter to correct sagging or sloping floor.

Kitchen cabinet misalignment may make range appear to be unlevel. Be sure cabinets are square and have sufficient room for range clearance.

Cannot move appliance easily. Appliance must be accessible for service.

Cabinets not square or are built in too tight. Contact a cabinet maker to correct the problem.

Contact builder or installer to make appliance accessible.

Carpeting interferes with range. Provide sufficient space so range can be lifted over carpet.

Entire range or oven does not operate.

Make sure cord/plug is tightly into outlet.

Service wiring is not complete. Contact your dealer, installing agent or authorized servicer.

Power outage. Check house lights to be sure. Call your local electric company for service.

*Oven control beeps and displays F1, F3 or F9.

Electronic control has detected a fault condition. Push **CLEAR** to clear the display and stop beeping. Program oven again. If fault recurs, record fault number. Push **CLEAR** and contact an authorized servicer.

Oven and/or cooktop lights does not work.

Replace or tighten bulb. See "Changing Oven Light" in this Guide for instructions.

Surface unit does not heat.

Element not making contact in block. Follow instructions under "Surface Elements and Drip Bowls" in the **General Cleaning** section.

No power to the appliance. Check steps under "Entire Range or Oven Does Not Operate" in this Avoid Service Checklist.

Incorrect control setting. Make sure the correct control is on for the surface unit to be used.

Scratches or abrasion on cooktop surface.

Coarse particules such as salt and sand between cooktop and utensils can cause scratches. Be sure cooktop surface and bottoms of utensils are clean before usage. Small scratches do not affect cooking and will become less visible with time.

Cleaning materials not recommended for ceramic-glass cooktop have been used. See "To Clean the Glass Cooktop" section under General Cleaning.

Cookware with rough bottom has been used. Use smooth, flat-bottomed cookware.

Surface element too hot or not hot enough.

Incorrect control setting. Make sure the correct control is on for the surface element to be used.

Metalmarks.	Sliding or scraping of metal utensils on cooktop surface. Do not slide metal utensils on cooktop surface. Use a ceramic-glass cooktop cleaning cream to remove the marks. See "To Clean the Cooktop Glass" section under General Cleaning.
Brown streaks or specks.	Boilovers are cooked onto surface. Use razor scraper to remove soil. See "To Clean the Cooktop Glass" section under General Cleaning.
Areas of discoloration with metallic sheen.	Mineral deposits from water and food. Remove using a ceramic-glass cooktop cleaning cream. Use cookware with clean, dry bottoms.
Poor baking results.	Many factors affect baking results. Make sure the proper rack position is used. Center food in the oven and space pans to allow air to circulate. Allow the oven to preheat to the set temperature before placing food in the oven. Try adjusting the recipes' recommended temperature or baking time. If you feel the oven is too hot or cool, see " Adjusting Oven Temperature " in the ELECTRONIC OVEN CONTROL section.
Flames inside oven or smoking from vent.	Excessive spillovers in oven. Set self-clean cycle for a longer cleaning time. Excessive spillovers in oven. This is normal, especially for pie spillovers or large amounts of grease on the oven bottom. Wipe up excessive spillovers before starting the self-clean cycle. If flames or excessive smoke are present, stop the self-clean cycle and follow the steps under " Stopping or Interrupting the Self-Cleaning Cycle " in the ELECTRONIC OVEN CONTROL section.
Oven smokes excessively during broiling.	Control(s) not set properly. Follow instructions under " Setting Oven Controls " in the ELECTRONIC OVEN CONTROL section. Make sure oven door is opened to the Broil Stop Position . Meat too close to the element. Reposition the rack to provide proper clearance between the meat and the element. Preheat broil element. Preheat broil element for searing. Grid on broiler pan wrong side up and grease not draining. Always place grid on the broiler pan with ribs up and slots down to allow grease to drip into pan. Grease has built up on oven surfaces. Regular cleaning is necessary when broiling frequently. Old grease or food spatters cause excessive smoking.
Self-cleaning cycle does not work.	Control(s) not set properly. Follow instructions under " Oven Cleaning " in the ELECTRONIC OVEN CONTROL section. Self-cleaning cycle was interrupted. Stop time must be 3 to 4 hours past the start time. Follow steps under " Stopping or Interrupting the Self-Cleaning Cycle " in the ELECTRONIC OVEN CONTROL section.
Soil not completely removed after self-cleaning cycle.	Failure to clean bottom, front top or oven, frame or door area outside oven seal. These areas are not in the self-cleaning area, but get hot enough to burn on residue. Clean these areas before the self-cleaning cycle is started. Burned-on residue can be cleaned with a stiff nylon brush and water or nylon scrubber. Be careful not to damage the oven seal.
Drip bowls are pitting or rusting.	Foods with acids, such as tomatoes, if allowed to stand in/on bowls will cause corrosion. Remove and wash drip bowls as soon as possible after a spillover. Normal environment. Houses along sea coast are exposed to salt air. Protect bowls as much as possible from direct exposure to salt air.
Drip bowls turning color or distorted out of shape.	Bottom surface of cookware extends beyond surface elements and touches cooktop surface. This can cause high enough temperatures to discolor the drip bowls. DO NOT use cookware of this type. Pan sizes should be matched to the size of the element. Replacement drip bowls may be purchased from your dealer.
Cooktop and/or Oven light (some models) does not work.	Replace or tighten bulb. See Changing Cooktop and/or Oven Lights (some models) in this Owner's Guide for instructions.

NOTES

NOTES

Warranty Information

RANGE WARRANTY

Your range is protected by this warranty

	WARRANTY PERIOD	THROUGH OUR AUTHORIZED SERVICERS, WE WILL:	THE CONSUMER WILL BE RESPONSIBLE FOR:
FULL ONE-YEAR WARRANTY	One year from original purchase date	Pay all costs for repairing or replacing any parts of this appliance which prove to be defective in materials or workmanship.	Costs of service calls that are listed under NORMAL RESPONSIBILITIES OF THE CONSUMER. *
LIMITED 2ND-5TH YEAR WARRANTY (Glass Smoothtop, Seal & Elements)	Second through fifth years from original purchase date	Provide a replacement for any defective surface heating element, deteriorated rubberized-silicone seal (upswept models only), or glass smoothtop that cracks due to thermal breakage (not customer abuse).	Diagnostic and any transportation and labor costs which are required because of service.
LIMITED WARRANTY (Applicable to the State of Alaska)	Time periods listed above.	All of the provisions of the full and limited warranties above and the exclusions listed below apply.	Costs of the technician's travel to the home and any costs for pick up and delivery of the appliance required because of service.

In the **U.S.A.**, your appliance is warranted by Electrolux Home Products North America, a division of White Consolidated Industries, Inc. We authorize no person to change or add to any of our obligations under this warranty. Our obligations for service and parts under this warranty must be performed by us or an authorized Electrolux Home Products North America servicer. In **Canada**, your appliance is warranted by Electrolux Canada Corp.

*NORMAL RESPONSIBILITIES OF THE CONSUMER

This warranty applies only to products in ordinary household use, and the consumer is responsible for the items listed below:

1. Proper use of the appliance in accordance with instructions provided with the product.
2. Proper installation by an authorized servicer in accordance with instructions provided with the appliance and in accordance with all local plumbing, electrical and/or gas codes.
3. Proper connection to a grounded power supply of sufficient voltage, replacement of blown fuses, repair of loose connections or defects in house wiring.
4. Expenses for making the appliance accessible for servicing, such as removal of trim, cupboards, shelves, etc., which are not a part of the appliance when it was shipped from the factory.
5. Damages to finish after installation.
6. Replacement of light bulbs and/or fluorescent tubes (on models with these features).

EXCLUSIONS

This warranty does not cover the following:

1. CONSEQUENTIAL OR INCIDENTAL DAMAGES SUCH AS PROPERTY DAMAGE AND INCIDENTAL EXPENSES RESULTING FROM ANY BREACH OF THIS WRITTEN OR ANY IMPLIED WARRANTY.
NOTE: Some states do not allow the exclusion or limitation of incidental or consequential damages, so this limitation or exclusion may not apply to you.
2. Service calls which do not involve malfunction or defects in workmanship or material, or for appliances not in ordinary household use. The consumer shall pay for such service calls.
3. Damages caused by services performed by servicers other than Electrolux Home Products North America or its authorized servicers; use of parts other than genuine Electrolux Home Products parts; obtained from persons other than such servicers; or external causes such as abuse, misuse, inadequate power supply or acts of God.
4. Products with original serial numbers that have been removed or altered and cannot be readily determined.

IF YOU NEED SERVICE

Keep your bill of sale, delivery slip, or some other appropriate payment record. The date on the bill establishes the warranty period should service be required. If service is performed, it is in your best interest to obtain and keep all receipts. This written warranty gives you specific legal rights. You may also have other rights that vary from state to state. Service under this warranty must be obtained by contacting Electrolux Home Products:

USA
1•800•944•9044
 Electrolux Home Products
 North America
 P.O. Box 212378
 Augusta, GA 30917

Canada
1•866•294•9911
 Electrolux Home Products
 North America
 802, boul. L'Ange-Gardien
 L'Assomption, Québec
 J5W 1T6

This warranty only applies in the 50 states of the U.S.A., Puerto Rico, and Canada. Product features or specifications as described or illustrated are subject to change without notice. All warranties are made by Electrolux Home Products North America, a division of White Consolidated Industries, Inc. In **Canada**, your appliance is warranted by Electrolux Canada Corp.