

# CD/DVD Player

## Operating Instructions

### For customers in the U.S.A

#### Owner's Record

The model and serial numbers are located at the rear of the unit. Record the serial number in the space provided below. Refer to them whenever you call upon your Sony dealer regarding this product.

Model No. DVP-NS90V

Serial No. \_\_\_\_\_

### For Customers in Canada

If this product is not working properly, please call 1-877-602-2008 for **Peace of Mind Warranty Replacement service.**

For other product related questions please contact our **Customer Information Service Centre** at 1-877-899-7669 or write to us at: Customer Information Service 115 Gordon Baker Road, Toronto, Ontario, M2H 3R6



## DVP-NS90V

# WARNING

To reduce the risk of fire or electric shock, do not expose this apparatus to rain or moisture.

To avoid electrical shock, do not open the cabinet. Refer servicing to qualified personnel only.

The AC power cord must be changed only at a qualified service shop.

## CAUTION

The use of optical instruments with this product will increase eye hazard. As the laser beam used in this CD/DVD player is harmful to eyes, do not attempt to disassemble the cabinet.

Refer servicing to qualified personnel only.

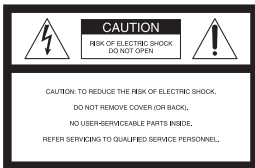

This symbol is intended to alert the user to the presence of uninsulated "dangerous voltage" within the product's enclosure that may be of sufficient magnitude to constitute a risk of electric shock to persons.



This symbol is intended to alert the user to the presence of important operating and maintenance (servicing) instructions in the literature accompanying the appliance.

## CAUTION

You are cautioned that any changes or modifications not expressly approved in this manual could void your authority to operate this equipment.



### Disposal of Old Electrical & Electronic Equipment

This symbol is applicable only in the European Union and other European countries with separate collection systems.

## Note

This equipment has been tested and found to comply with the limits for a Class B digital device, pursuant to Part 15 of the FCC Rules. These limits are designed to provide reasonable protection against harmful interference in a residential installation. This equipment generates, uses, and can radiate radio frequency energy and, if not installed and used in accordance with the instructions, may cause harmful interference to radio communications. However, there is no guarantee that interference will not occur in a particular installation. If this equipment does cause harmful interference to radio or television reception, which can be determined by turning the equipment off and on, the user is encouraged to try to correct the interference by one or more of the following measures:

- Reorient or relocate the receiving antenna.
- Increase the separation between the equipment and receiver.
- Connect the equipment into an outlet on a circuit different from that to which the receiver is connected.
- Consult the dealer or an experienced radio/TV technician for help.

# Notes About the Discs

- To keep the disc clean, handle the disc by its edge. Do not touch the surface.



- Do not expose the disc to direct sunlight or heat sources such as hot air ducts, or leave it in a car parked in direct sunlight as the temperature may rise considerably inside the car.
- After playing, store the disc in its case.
- Clean the disc with a cleaning cloth. Wipe the disc from the center out.



- Do not use solvents such as benzene, thinner, commercially available disc/lens cleaners, or anti-static spray intended for vinyl LPs.
- If you have printed the disc's label, dry the label before playing.

# Important Safeguards

For your protection, please read these safety instructions completely before operating the appliance, and keep this manual for future reference. Carefully observe all warnings, precautions and instructions on the appliance, or the one described in the operating instructions and adhere to them.

## Use

### Power sources

This set should be operated only from the type of power source indicated on the marking label. If you are not sure of the type of electrical power supplied to your home, consult your dealer or local power company. For those sets designed to operate from battery power, or other sources, refer to the operating instructions.



### Grounding or Polarization

This set is equipped with a polarized ac power cord plug (a plug having one blade wider than the other), or with a three-wire grounding type plug (a plug having a third pin for grounding). Follow the instructions below:

#### For the set with a polarized AC power cord plug:

This plug will fit into the power outlet only one way. This is a safety feature. If you are unable to insert the plug fully into the outlet, try reversing the plug. If the plug should still fail to fit, contact your electrician to have a suitable outlet installed. Do not defeat the safety purpose of the polarized plug by forcing it in.



#### For the set with a three-wire grounding type AC plug:

This plug will only fit into a grounding-type power outlet. This is a safety feature. If you are unable to insert the plug into the outlet, contact your electrician to have a suitable outlet installed. Do not defeat the safety purpose of the grounding plug.

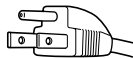

### Overloading

Do not overload wall outlets, extension cords or convenience receptacles beyond their capacity, since this can result in fire or electric shock.



### Object and Liquid Entry

Never push objects of any kind into the set through openings as they may touch dangerous voltage points or short out parts that could result in a fire or electric shock. Never spill liquid of any kind on the set.



## Attachments

Do not use attachments not recommended by the manufacturer, as they may cause hazards.



## Cleaning

Unplug the set from the wall outlet before cleaning or polishing it. Do not use liquid cleaners or aerosol cleaners. Use a cloth lightly dampened with water for cleaning the exterior of the set.

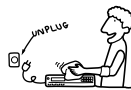

## Installation

### Water and Moisture

Do not use power-line operated sets near water - for example, near a bathtub, washbowl, kitchen sink, or laundry tub, in a wet basement, or near a swimming pool, etc.



### Power-Cord Protection

Route the power cord so that it is not likely to be walked on or pinched by items placed upon or against them, paying particular attention to the plugs, receptacles, and the point where the cord exits from the appliance.

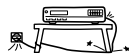

### Accessories

Do not place the set on an unstable cart, stand, tripod, bracket, or table. The set may fall, causing serious injury to a child or an adult, and serious damage to the set. Use only a cart stand tripod, bracket, or table recommended by the manufacturer.



An appliance and cart combination should be moved with care. Quick stops, excessive force, and uneven surfaces may cause the appliance and cart combination to overturn.



S3125A

## Ventilation

The slots and openings in the cabinet are provided for necessary ventilation. To ensure reliable operation of the set, and to protect it from overheating, these slots and openings must never be blocked or covered.

- Never cover the slots and openings with a cloth or other materials.

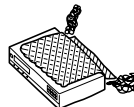

- Never block the slots and openings by placing the set on a bed, sofa, rug or other similar surface.



- Never place the set in a confined space, such as a bookcase, or built-in cabinet, unless proper ventilation is provided.



- Do not place the set near or over a radiator or heat register, or where it is exposed to direct sunlight.



## Antennas

### Outdoor antenna grounding

If an outdoor antenna or cable system is installed, follow the precautions below.

An outdoor antenna system should not be located in the vicinity of overhead power lines or other electric light or power circuits, or where it can come in contact with such power lines or circuits.

WHEN INSTALLING AN OUTDOOR ANTENNA SYSTEM, EXTREME CARE SHOULD BE TAKEN TO KEEP FROM CONTACTING SUCH POWER LINES OR CIRCUITS AS CONTACT WITH THEM IS ALMOST INVARIABLY FATAL.

Be sure the antenna system is grounded so as to provide some protection against voltage surges and built-up static charges. Section 810 of the National Electrical Code provides information with respect to proper grounding of the mast and supporting structure, grounding of the lead-in wire to an antenna discharge unit, size of grounding conductors, location of antenna-discharge unit, connection to grounding electrodes, and requirements for the grounding electrode.

### Antenna Grounding According to the National Electrical Code

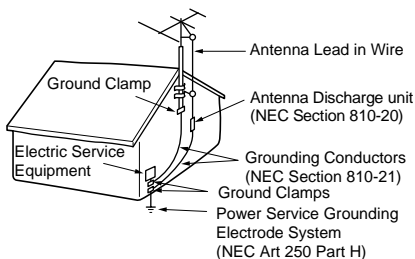

NEC-NATIONAL ELECTRICAL CODE

### Lightning

For added protection for this set during a lightning storm, or when it is left unattended and unused for long periods of time, unplug it from the wall outlet and disconnect the antenna or cable system. This will prevent damage to the set due to lightning and power-line surges.

## Service

### Damage Requiring Service

Unplug the set from the wall outlet and refer servicing to qualified service personnel under the following conditions:

- When the power cord or plug is damaged or frayed.

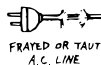

- If liquid has been spilled or objects have fallen into the set.



- If the set has been exposed to rain or water.



- If the set has been subject to excessive shock by being dropped, or the cabinet has been damaged.



- If the set does not operate normally when following the operating instructions. Adjust only those controls that are specified in the operating instructions. Improper adjustment of other controls may result in damage and will often require extensive work by a qualified technician to restore the set to normal operation.
- When the set exhibits a distinct change in performance - this indicates a need for service.



### Servicing

Do not attempt to service the set yourself as opening or removing covers may expose you to dangerous voltage or other hazards.



Refer all servicing to qualified service personnel.

### Replacement parts

When replacement parts are required, be sure the service technician has used replacement parts specified by the manufacturer that have the same characteristics as the original parts.

Unauthorized substitutions may result in fire, electric shock, or other hazards.

### Safety Check

Upon completion of any service or repairs to the set, ask the service technician to perform routine safety checks (as specified by the manufacturer) to determine that the set is in safe operating condition.



---

## Precautions

### On safety

- To prevent fire or shock hazard, do not place objects filled with liquids, such as vases, on the apparatus.
- Should any solid object or liquid fall into the cabinet, unplug the player and have it checked by qualified personnel before operating it any further.

### On power sources

- The player is not disconnected from the AC power source as long as it is connected to the wall outlet, even if the player itself has been turned off.
- If you are not going to use the player for a long time, be sure to disconnect the player from the wall outlet. To disconnect the AC power cord, grasp the plug itself; never pull the cord.

### On placement

- Place the player in a location with adequate ventilation to prevent heat build-up in the player.
- Do not place the player on a soft surface such as a rug.
- Do not place the player in a location near heat sources, or in a place subject to direct sunlight, excessive dust, or mechanical shock.
- Do not install the player in an inclined position. It is designed to be operated in a horizontal position only.
- Keep the player and the discs away from equipment with strong magnets, such as microwave ovens, or large loudspeakers.
- Do not place heavy objects on the player.

### On operation

- If the player is brought directly from a cold to a warm location, or is placed in a very damp room, moisture may condense on the lenses inside the player. Should this occur, the player may not operate properly. In this case, remove the disc and leave the player turned on for about half an hour until the moisture evaporates.
- When you move the player, take out any discs. If you don't, the disc may be damaged.

### On adjusting volume

Do not turn up the volume while listening to a section with very low level inputs or no audio signals. If you do, the speakers may be damaged when a peak level section is played.

### On cleaning

Clean the cabinet, panel, and controls with a soft cloth slightly moistened with a mild detergent solution. Do not use any type of abrasive pad, scouring powder or solvent such as alcohol or benzine.

### On cleaning discs, disc/lens cleaners

**Do not use a commercially available cleaning disc or disc/lens cleaner (wet or spray type). These may cause the apparatus to malfunction.**

#### IMPORTANT NOTICE

Caution: This player is capable of holding a still video image or on-screen display image on your television screen indefinitely. If you leave the still video image or on-screen display image displayed on your TV for an extended period of time you risk permanent damage to your television screen. Plasma display panel televisions and projection televisions are susceptible to this.

If you have any questions or problems concerning your player, please consult your nearest Sony dealer.

# Table of Contents

WARNING	2
Notes About the Discs	2
Important Safeguards	3
Precautions	5
About This Manual	7
This Player Can Play the Following Discs	8
Index to Parts and Controls	10
Guide to the Control Menu Display	14
<hr/>	
<b>Hookups</b>	<b>17</b>
Hooking Up the Player	17
Step 1: Unpacking	17
Step 2: Inserting Batteries Into the Remote	17
Step 3: Connecting the Video Cords/HDMI Cords	18
Step 4: Connecting the Audio Cords	22
Step 5: Connecting the Power Cord	25
Step 6: Quick Setup	25
<hr/>	
<b>Playing Discs</b>	<b>28</b>
Playing Discs	28
Resuming Playback From the Point Where You Stopped the Disc (Multi-disc Resume)	30
Using the DVD's Menu	31
Selecting "ORIGINAL" or "PLAY LIST" on a DVD-RW/DVD-R	31
Selecting a Playback Area for a Super Audio CD	32
Playing VIDEO CDs With PBC Functions (PBC Playback)	33
Various Play Mode Functions (Program Play, Shuffle Play, Repeat Play, A-B Repeat Play)	34
<hr/>	
<b>Searching for a Scene</b>	<b>38</b>
Searching for a Particular Point on a Disc (Search, Scan, Slow-motion Play, Freeze Frame)	38
Searching for a Title/Chapter/Track/Scene, etc. (Search mode)	39
Searching by Scene (PICTURE NAVIGATION)	41
<hr/>	
<b>Viewing Information About the Disc</b>	<b>42</b>
Checking the Playing Time and Remaining Time	42
<hr/>	
<b>Sound Adjustments</b>	<b>45</b>
Changing the Sound	45
Surround Mode Settings	46
<hr/>	
<b>Enjoying Movies</b>	<b>50</b>
Changing the Angles	50
Displaying the Subtitles	50
Adjusting the Playback Picture (CUSTOM PICTURE MODE)	51
Sharpening the Pictures (SHARPNESS)	52

Adjusting the Picture Quality (BNR, MNR) . . . . .	53
Adjusting the Delay Between the Picture and Sound (AV SYNC) . . . . .	55

<b>Enjoying MP3 Audio and JPEG Images . . . . .</b>	<b>56</b>
About MP3 Audio Tracks and JPEG Image Files . . . . .	56
Playing MP3 Audio Tracks or JPEG Image Files . . . . .	57
Enjoying JPEG Images as a Slide Show . . . . .	60







<b>Using Various Additional Functions . . . . .</b>	<b>62</b>
Locking Discs (CUSTOM PARENTAL CONTROL, PARENTAL CONTROL) . . . . .	62
Controlling Your TV or AV Amplifier (Receiver) With the Supplied Remote . . . . .	65

<b>Settings and Adjustments . . . . .</b>	<b>68</b>
Using the Setup Display . . . . .	68
Setting the Display or Sound Track Language (LANGUAGE SETUP) . . . . .	69
Settings for the Display (SCREEN SETUP) . . . . .	70
Custom Settings (CUSTOM SETUP) . . . . .	72
Settings for the Sound (AUDIO SETUP) . . . . .	73
Settings for the Speakers (SPEAKER SETUP) . . . . .	75

<b>Additional Information . . . . .</b>	<b>78</b>
Troubleshooting . . . . .	78
Self-diagnosis Function (When letters/numbers appear in the display) . . . . .	81
Glossary . . . . .	81
Specifications . . . . .	84
Language Code List . . . . .	85
Index . . . . .	86











## About This Manual

- Instructions in this manual describe the controls on the remote. You can also use the controls on the player if they have the same or similar names as those on the remote.
- “DVD” may be used as a general term for DVD VIDEOS, DVD+RWs/DVD+Rs and DVD-RWs/DVD-Rs.
- The meaning of the icons used in this manual is described below:

Icons	Meaning
	Functions available for DVD VIDEOS and DVD+RWs/DVD+Rs in +VR mode or DVD-RWs/DVD-Rs in video mode
	Functions available for DVD-RWs/DVD-Rs in VR (Video Recording) mode
	Functions available for VIDEO CDs (including Super VCDs or CD-Rs/CD-RWs in video CD format or Super VCD format)
	Functions available for Super Audio CDs
	Functions available for music CDs or CD-Rs/CD-RWs in music CD format
	Functions available for DATA CDs (CD-ROMs/CD-Rs/CD-RWs) containing MP3* audio tracks, and JPEG image files
	Functions available for DATA DVDs (DVD-ROMs/DVD+RWs/DVD+Rs/DVD-RWs/DVD-Rs) containing MP3* audio tracks, and JPEG image files

\* MP3 (MPEG-1 Audio Layer III) is a standard format defined by ISO (International Organization for Standardization)/IEC (International Electrotechnical Commission) MPEG which compresses audio data.

## This Player Can Play the Following Discs

Format of discs	
DVD VIDEO	
DVD-RW/-R	 
DVD+RW/+R	  
Super Audio CD	 SUPER AUDIO CD
VIDEO CD/ Music CD	 
CD-RW/-R	 

“DVD+RW,” “DVD-RW,” “DVD+R,” “DVD-R,” “DVD VIDEO,” and “CD” logos are trademarks.

### Note about CDs/DVDs

The player can play CD-ROMs/CD-Rs/CD-RWs recorded in the following formats:

- music CD format
- video CD format
- MP3 audio tracks and JPEG image files of format conforming to ISO 9660\* Level 1/Level 2, or its extended format, Joliet
- KODAK Picture CD format

\* A logical format of files and folders on CD-ROMs, defined by ISO (International Organization for Standardization).

The player can play DVD-ROMs/DVD+RWs/DVD-RWs/DVD+Rs/DVD-Rs recorded in the following format:

- MP3 audio tracks and JPEG image files of format conforming to UDF (Universal Disk Format).

## Example of discs that the player cannot play

The player cannot play the following discs:

- CD-ROMs/CD-Rs/CD-RWs other than those recorded in the formats listed on this page.
- CD-ROMs recorded in PHOTO CD format.
- Data part of CD-Extras.
- DVD Audio discs.

Also, the player cannot play the following discs:

- A DVD VIDEO with a different region code.
- A disc recorded in a color system other than NTSC, such as PAL or SECAM (this player conforms to the NTSC color system).
- A disc that has a non-standard shape (e.g., card, heart).
- A disc with paper or stickers on it.
- A disc that has the adhesive of cellophane tape or a sticker still left on it.

### Region code

Your player has a region code printed on the back of the unit and only will play DVD VIDEOS (playback only) labeled with identical region codes. This system is used to protect copyrights.

DVD VIDEOS labeled  will also play on this player.

If you try to play any other DVD VIDEO, the message “Playback prohibited by area limitations.” will appear on the TV screen. Depending on the DVD VIDEO, there may be no region code indication, even though playing the DVD VIDEO is prohibited by area restrictions.

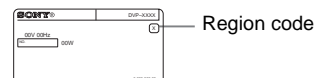

## Notes

- **Notes about DVD+RWs/DVD+Rs, DVD-RWs/DVD-Rs or CD-Rs/CD-RWs**

Some DVD+RWs/DVD+Rs, DVD-RWs/DVD-Rs, or CD-Rs/CD-RWs cannot be played on this player due to the recording quality or physical condition of the disc, or the characteristics of the recording device and authoring software.

The disc will not play if it has not been correctly finalized. For more information, refer to the operating instructions for the recording device.

Note that some playback functions may not work with some DVD+RWs/DVD+Rs, even if they have been correctly finalized. In this case, view the disc by normal playback. Also some DATA CDs/DATA DVDs created in Packet Write format cannot be played.

- **Music discs encoded with copyright protection technologies**

This product is designed to playback discs that conform to the Compact Disc (CD) standard. Recently, various music discs encoded with copyright protection technologies are marketed by some record companies. Please be aware that among those discs, there are some that do not conform to the CD standard and may not be playable by this product.

- **Note on DualDiscs**

A DualDisc is a two sided disc product which mates DVD recorded material on one side with digital audio material on the other side. However, since the audio material side does not conform to the Compact Disc (CD) standard, playback on this product is not guaranteed.

---

## Note on playback operations of DVDs and VIDEO CDs

Some playback operations of DVDs and VIDEO CDs may be intentionally set by software producers. Since this player plays DVDs and VIDEO CDs according to the disc contents the software producers designed, some playback features may not be available. Also, refer to the instructions supplied with the DVDs or VIDEO CDs.

---

## Copyrights





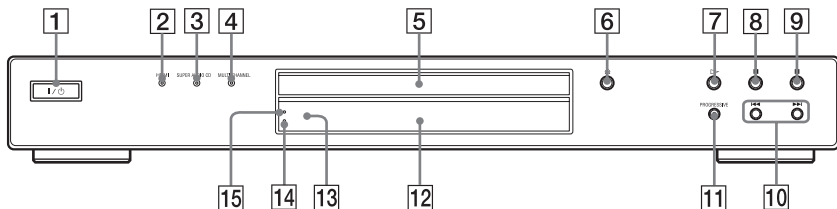

This product incorporates copyright protection technology that is protected by U.S. patents and other intellectual property rights. Use of this copyright protection technology must be authorized by Macrovision, and is intended for home and other limited viewing uses only unless otherwise authorized by Macrovision. Reverse engineering or disassembly is prohibited.

# Index to Parts and Controls

For more information, see the pages indicated in parentheses.

## Front panel



- 1**  (on/standby) button (28)
- 2** HDMI\* (High-Definition Multimedia Interface) indicator (19, 70, 73, 82)  
Lights up when the HDMI OUT jack is correctly connected to a HDCP (High-bandwidth Digital Content Protection) compliant device with HDMI or DVI (Digital Visual Interface) input.
- 3** SUPER AUDIO CD indicator (32, 83)  
Lights up when:
  - playing a HD (High Density) layer of Super Audio CDs.
  - no disc is inserted.
- 4** MULTICHANNEL indicator (32, 83)  
Lights up when:
  - playing a disc that contains multiple audio signal channels.
  - no disc is inserted.
- 5** Disc tray (28)
- 6**  (open/close) button (28)
- 7**  (play) button (28)
- 8**  (pause) button (29)
- 9**  (stop) button (29)
- 10**  (previous/next) buttons (38)
- 11** PROGRESSIVE button/indicator (21)  
Lights up when the player outputs progressive signals.
- 12** Front panel display (12)
- 13** Remote sensor (17)
- 14** FL OFF (Front panel display off) indicator (72)
- 15** VIDEO OFF indicator (28)

\* This player is based on version 1.1 of High-Definition Multimedia Interface Specifications.

This DVD player incorporates High-Definition Multimedia Interface (HDMI™) technology.

HDMI, the HDMI logo and High-Definition Multimedia Interface are trademarks or registered trademarks of HDMI Licensing LLC.

## Rear panel

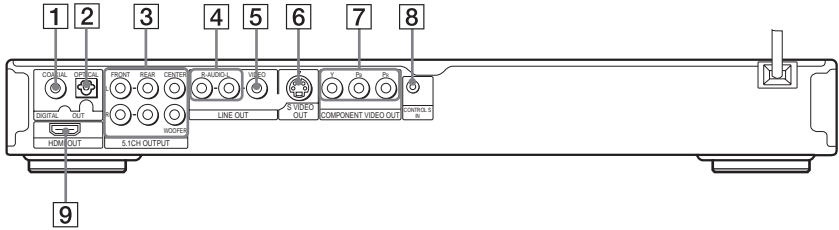

- |  |  |
|--|--|
| <b>1</b> DIGITAL OUT (COAXIAL) jack (22) | <b>6</b> S VIDEO OUT jack (18)   |
| <b>2</b> DIGITAL OUT (OPTICAL) jack (22) | <b>7</b> COMPONENT VIDEO OUT jacks (18) (Y, Pb, Pr)                    |
| <b>3</b> 5.1CH OUTPUT jacks (22)         | <b>8</b> CONTROL S IN jack (18)  |
| <b>4</b> LINE OUT L/R (AUDIO) jacks (22) | <b>9</b> HDMI OUT (high-definition multimedia interface out) jack (18) |
| <b>5</b> LINE OUT (VIDEO) jack (18)      |  |

## Front panel display

When playing back a DVD VIDEO/DVD-VR mode disc

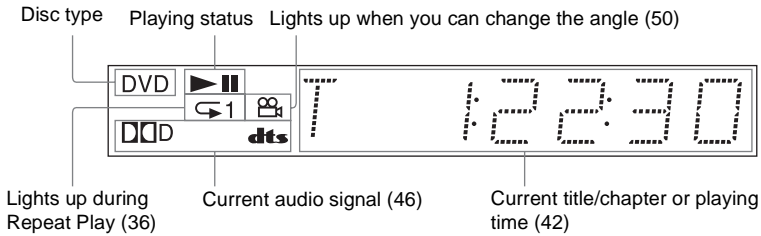

When playing back a VIDEO CD with Playback Control (PBC) (33)

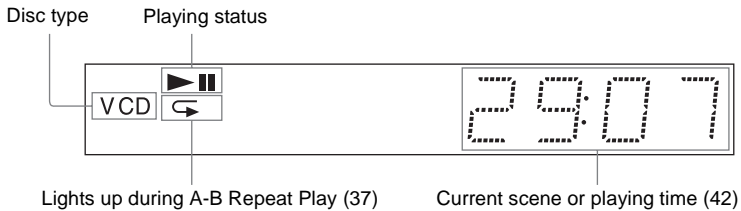

When playing back a Super Audio CD, CD, DATA CD/DATA DVD (MP3 audio) or VIDEO CD (without PBC)

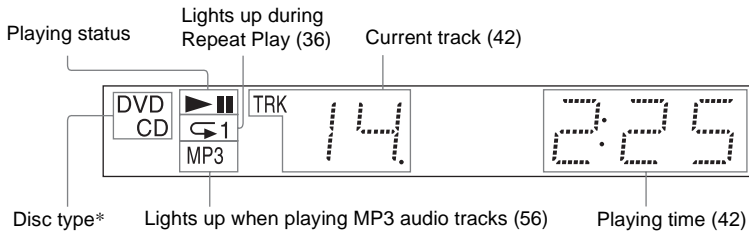

\* When playing DATA DVDs, the DVD indicator is displayed. When playing the HD layer of Super Audio CDs, the disc type is not displayed.

### Hint

You can adjust the lighting of the front panel display by setting "DISPLAY" in "CUSTOM SETUP." (page 72)

## Remote

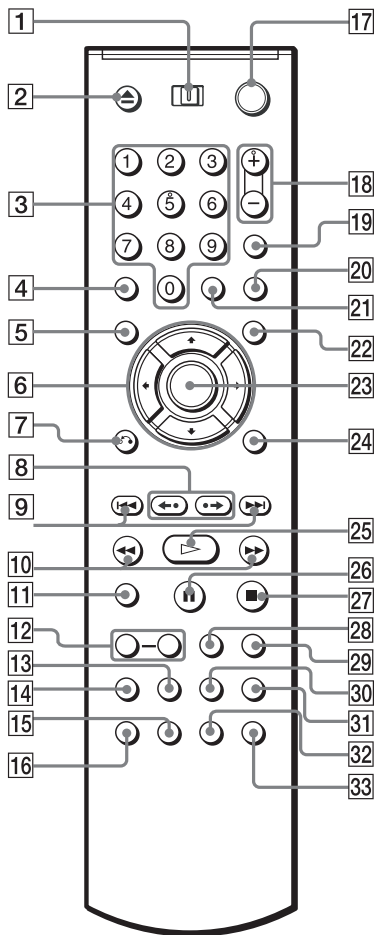

- 1** TV/DVD switch (42)
- 2** ▲ OPEN/CLOSE button (29)
- 3** Number buttons (31)  
The number 5 button has a tactile dot.\*
- 4** CLEAR button (34)
- 5** TOP MENU button (31)
- 6** ←/↑/↓/→ buttons (31)
- 7** ↻ RETURN button (29)
- 8** ◀◀/▶▶/▶▶▶▶ REPLAY/STEP/  
ADVANCE/STEP buttons (29, 39)

- 9** ◀◀/▶▶ PREV/NEXT (previous/  
next) buttons (29)
- 10** ◀◀◀◀/▶▶▶▶ SCAN/SLOW  
buttons (39)
- 11** ZOOM button (29, 59)
- 12** SLOW PLAY/FAST PLAY buttons  
(29)
- 13** SA-CD/CD button (32)
- 14** SA-CD MULTI/2CH button (32)
- 15** SUBTITLE button (50)
- 16** AUDIO button (45)
- 17** I/⏻ (on/standby) button (28)
- 18** VOL (volume) +/- buttons (65)  
The + button has a tactile dot.\*
- 19** TV/VIDEO/TIME/TEXT button (42)
- 20** PICTURE NAVI (picture navigation)  
button (41, 59)
- 21** ENTER button (65)
- 22** MENU button (31)
- 23** ENTER button (25)
- 24** DISPLAY button (14)
- 25** ▷ PLAY button (28)  
The ▷ button has a tactile dot.\*
- 26** ⏸ PAUSE button (29)
- 27** ■ STOP button (29)
- 28** SHUFFLE button (34)
- 29** REPEAT button (34)
- 30** SUR button (46)
- 31** SEARCH MODE button (39)
- 32** ANGLE button (50)
- 33** VIDEO ON/OFF button (28)

\* Use the tactile dot as a reference when operating the player.

# Guide to the Control Menu Display

Use the Control Menu to select a function and to view related information. Press DISPLAY repeatedly to turn on or change the Control Menu display as follows:

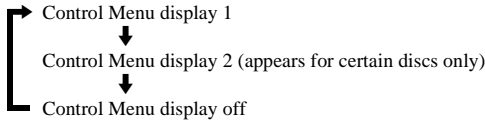

## Control Menu display

The Control Menu display 1 and 2 will show different items depending on the disc type. For details about each item, see the pages in parentheses.

Example: Control Menu display 1 when playing a DVD VIDEO.

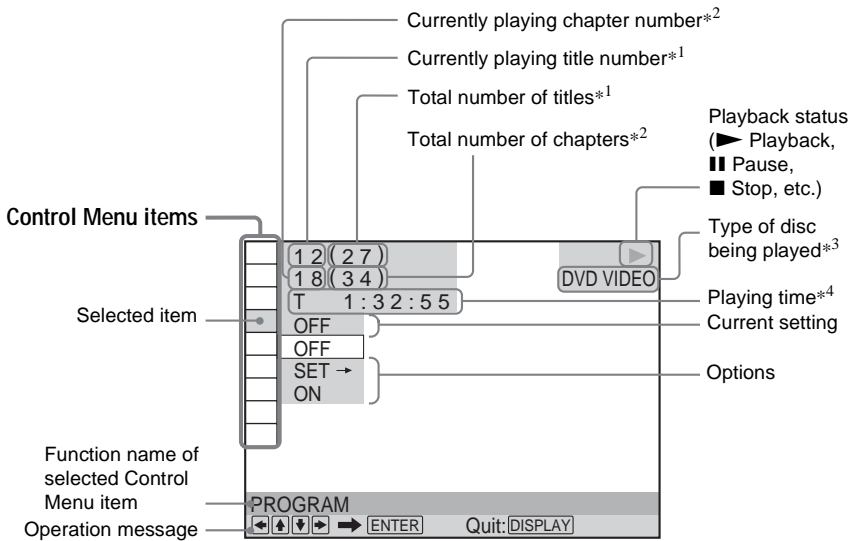

\*1 Displays the scene number for VIDEO CDs (PBC is on), track number for VIDEO CDs/Super Audio CDs/CDs, album number for DATA CDs/DATA DVDs.

\*2 Displays the index number for VIDEO CDs/Super Audio CDs, MP3 audio track number or JPEG image file number for DATA CDs/DATA DVDs.

















\*3 Displays Super VCD as "SVCD."







\*4 Displays the date for JPEG files.

### To turn off the display

Press DISPLAY repeatedly.



## List of Control Menu items

Item	Item Name, Function
	<b>TITLE (page 39)/SCENE (page 39)/TRACK (page 39)</b> Selects the title, scene or track to be played.
	<b>CHAPTER (page 39)/INDEX (page 39)</b> Selects the chapter or index to be played.
	<b>TRACK (page 39)</b> Selects the track to be played.
	<b>ORIGINAL/PLAY LIST (page 31)</b> Selects the type of titles (DVD-RW/DVD-R in VR mode) to be played, the ORIGINAL one, or an edited PLAY LIST.
	<b>TIME/TEXT (page 40)</b> Checks the elapsed time and the remaining playback time. Input the time code for picture and music searching. Displays the DVD/Super Audio CD/CD text or the DATA CD/DATA DVD track/file name.
	<b>MULTI/2CH (page 32)</b> Selects the playback area on Super Audio CDs when available.
	<b>PROGRAM (page 34)</b> Selects the title, chapter or track to play in the order you want.
	<b>SHUFFLE (page 36)</b> Plays the title, chapter or track in random order.
	<b>REPEAT (page 36)</b> Plays the entire disc (all titles/all tracks/all albums) repeatedly or one title/chapter/track/album repeatedly.
	<b>A-B REPEAT (page 37)</b> Specifies the parts you want to play repeatedly.
	<b>BNR (page 53)</b> Adjusts the picture quality by reducing the “block noise” or mosaic like patterns that appear on your TV screen.
	<b>MNR (page 53)</b> Adjusts the picture quality by reducing the faint noise appearing around the outlines of the images.
	<b>CUSTOM PICTURE MODE (page 51)</b> Adjusts the video signal from the player. You can select the picture quality that best suits the program you are watching.
	<b>SHARPNESS (page 52)</b> Exaggerates the outline of the image to produce a sharper picture.
	<b>AV SYNC (page 55)</b> Adjust the delay between the picture and sound.
	<b>PARENTAL CONTROL (page 62)</b> Set to prohibit playback on this player.
	<b>SETUP (page 68)</b> QUICK Setup (page 25) Use Quick Setup to choose the desired language of the on-screen display, the aspect ratio of the TV, the audio output signal and the size of the speaker you are using. CUSTOM Setup In addition to the Quick Setup setting, you can adjust various other settings. RESET Returns the settings in “SETUP” to the default setting.

	<b>ALBUM (page 56)</b> Selects the album to be played.
	<b>FILE (page 39)</b> Selects the JPEG image file to be played.
	<b>DATE (page 59)</b> Displays the date the picture was taken by a digital camera.
	<b>INTERVAL (page 61)</b> Specifies the duration for which the slides are displayed on the screen.
	<b>EFFECT (page 61)</b> Selects the effects to be used for changing slides during a slide show.
	<b>MODE (MP3, JPEG) (page 60)</b> Selects the data type; MP3 audio track (AUDIO), JPEG image file (IMAGE) or both (AUTO) to be played when playing a DATA CD or DATA DVD.

### **Hint**

The Control Menu icon indicator lights up in green

 →  when you select any item except "OFF" ("PROGRAM," "SHUFFLE," "REPEAT," "A-B REPEAT," "BNR," "MNR," "CUSTOM PICTURE MODE," "SHARPNESS" only). The "ORIGINAL/PLAY LIST" indicator lights up in green when you select "PLAY LIST" (default setting). The "MULTI/2CH" indicator lights up in green when you select the multi-channel playback area on a Super Audio CD. The "AV SYNC" indicator lights up in green when set to more than 0 ms.

## Hooking Up the Player

Follow steps 1 to 6 to hook up and adjust the settings of the player.

### Notes

- Plug cords securely to prevent unwanted noise.
- Refer to the instructions supplied with the components to be connected.
- You cannot connect this player to a TV that does not have a video input jack.
- Be sure to disconnect the power cord of each component before connecting.

## Step 1: Unpacking

Check that you have the following items:

- Audio/Video cord (phono plug × 3 ↔ phono plug × 3) (1)
- Remote commander (remote) (1)
- Size AA (R6) batteries (2)

## Step 2: Inserting Batteries Into the Remote

You can control the player using the supplied remote. Insert two Size AA (R6) batteries by matching the ⊕ and ⊖ ends on the batteries to the markings inside the compartment. When using the remote, point it at the remote sensor  on the player.

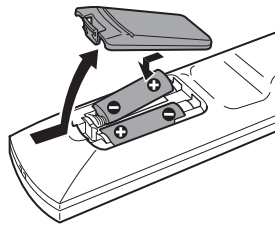

### Notes

- Do not leave the remote in an extremely hot or humid place.
- Do not drop any foreign object into the remote casing, particularly when replacing the batteries.
- Do not expose the remote sensor to direct light from the sun or a lighting apparatus. Doing so may cause a malfunction.
- If you do not use the remote for an extended period of time, remove the batteries to avoid possible damage from battery leakage and corrosion.

## Step 3: Connecting the Video Cords/HDMI Cords

Connect this player to your TV monitor, projector or AV amplifier (receiver) using a video cord. Select one of the patterns **A** through **D**, according to the input jack on your TV monitor, projector or AV amplifier (receiver).

In order to view progressive signal 480p (525p) pictures with a compatible TV, projector or monitor, you must use pattern **D**. Select pattern **C** when connecting to a TV, projector or AV amplifier (receiver) equipped with HDMI input.

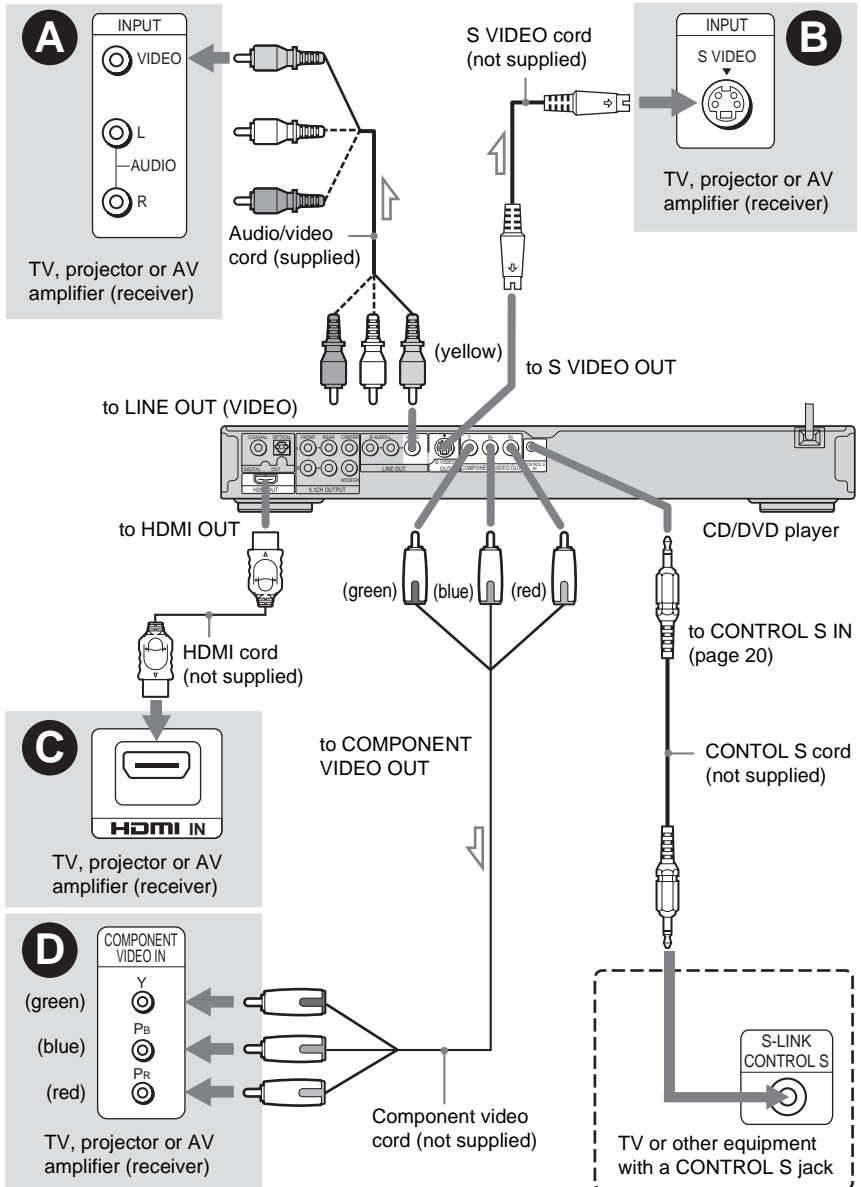

## A If you are connecting to a video input jack

Connect the yellow plug of an audio/video cord (supplied) to the yellow (video) jack. You will enjoy standard quality images.

With this connection, select “NORMAL (INTERLACE)” (default) by pressing the PROGRESSIVE button on the front panel.



## B If you are connecting to an S VIDEO input jack

Connect an S VIDEO cord (not supplied). You will enjoy high quality images.

With this connection, select “NORMAL (INTERLACE)” (default) by pressing the PROGRESSIVE button on the front panel.



## C If you are connecting to an HDMI/DVI input jack

Use a certified Sony HDMI cord (not supplied) to enjoy high quality digital picture and sound through the HDMI OUT jack.

Note that Super Audio CD sound is not output from the HDMI OUT jack.



### To connect to a TV with DVI input

Use an HDMI-DVI converter cord (not supplied). The DVI jack will not accept any audio signals, so you have to use another audio connection in addition to this connection (page 22). Furthermore, you cannot connect the HDMI OUT jack to DVI jacks that are not HDCP compliant (e.g., DVI jacks on PC displays).

## D If you are connecting to a monitor, projector, or AV amplifier (receiver) having component video input jacks (Y, P<sub>B</sub>, P<sub>R</sub>)

Connect the component via the COMPONENT VIDEO OUT jacks using a component video cord (not supplied) or three video cords (not supplied) of the same kind and length. You will enjoy accurate color reproduction and high quality images.

If your TV accepts progressive 480p (525p) format signals\*, use this connection and press the PROGRESSIVE button on the front panel to output progressive signals. For details, see “Using the PROGRESSIVE button” (page 21).



\* The active number of progressive scan lines is 480, and the measured number of lines is 525.

## When connecting to a wide screen TV

Depending on the disc, the image may not fit your TV screen. To change the aspect ratio, see page 70.

### Hint

If your TV has a CONTROL S jack, you can control the player by operating the remote toward the TV. This feature is convenient when you placed the player and the TV away from each other. After connecting the player with other components according to the above **A**, **B**, **C** or **D**, connect the TV via the CONTROL S IN jack using a control S cord (not supplied). Refer to the instructions supplied with the TV to be connected. Note that your TV's input will not automatically switch to this player when you play a disc.



### Notes

- Do not connect a VCR, etc., between your TV and the player. If you pass the player signals via the VCR, you may not receive a clear image on the TV screen. If your TV has only one audio/video input jack, connect the player to this jack.

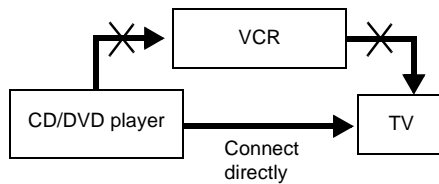

- If the picture appears too white when you are using **C** or **D** connection, set "BLACK LEVEL" in "SCREEN SETUP" to "OFF" (page 71).

## Using the PROGRESSIVE button

By using the PROGRESSIVE button on the front panel, you can select the signal format in which the player outputs video signals (Progressive or Interlace), and the conversion method for progressive signals. The PROGRESSIVE indicator lights up when the player outputs progressive signals.

Each time you press PROGRESSIVE, the display changes as follows:

PROGRESSIVE AUTO



PROGRESSIVE VIDEO



NORMAL (INTERLACE)

### ◆PROGRESSIVE AUTO

Select this setting when:

- your TV accepts progressive signals, and
- the TV is connected to the COMPONENT VIDEO OUT jacks.

Normally select this under the above condition. This automatically detects the software type, and selects the appropriate conversion method.

Note that the picture will not be clear or no picture will appear if you select these settings when either of the above conditions is not met.

### ◆PROGRESSIVE VIDEO

Select this setting when:

- your TV accepts progressive signals, and,
  - the TV is connected to the COMPONENT VIDEO OUT jacks, and,
  - you want to fix the conversion method to PROGRESSIVE VIDEO for video-based software.
- Select this if the image is not clear when you select PROGRESSIVE AUTO.

Note that the picture will not be clear or no picture will appear if you select these settings when either of the above conditions is not met.

### ◆NORMAL (INTERLACE)

Select this setting when:

- your TV does not accept progressive signals, or,
- your TV is connected to jacks other than the COMPONENT VIDEO OUT jacks (LINE OUT (VIDEO) or S VIDEO OUT).

You cannot select this setting while the HDMI indicator is lit.

## About DVD software types and the conversion method

DVD software can be divided into two types: film-based software and video based software.

Video-based software is derived from TV, such as dramas and sit-coms, and displays images at 30 frames/60 fields per second. Film-based software is derived from film and displays images at 24 frames per second. Some DVD software contains both video and film.

In order for these images to appear natural on your screen when output in progressive format, the progressive signals need to be converted to match the type of DVD software that you are watching.

### Notes

- When you play video-based software in progressive signal format, sections of some types of images may appear unnatural due to the conversion process when output through the COMPONENT VIDEO OUT jacks. Images from the S VIDEO OUT and LINE OUT (VIDEO) jacks are unaffected as they are output in the normal (interlace) format.
- When using LINE OUT (VIDEO) or S VIDEO OUT, the picture may appear to flicker each time the PROGRESSIVE button on the front panel is pressed (Interlace switches to Progressive or vice versa).

# Step 4: Connecting the Audio Cords

Select one of the following patterns **A**, **B-1** or **B-2**, according to the input jack on your TV monitor, projector, or AV amplifier (receiver). This will enable you to listen to sound.

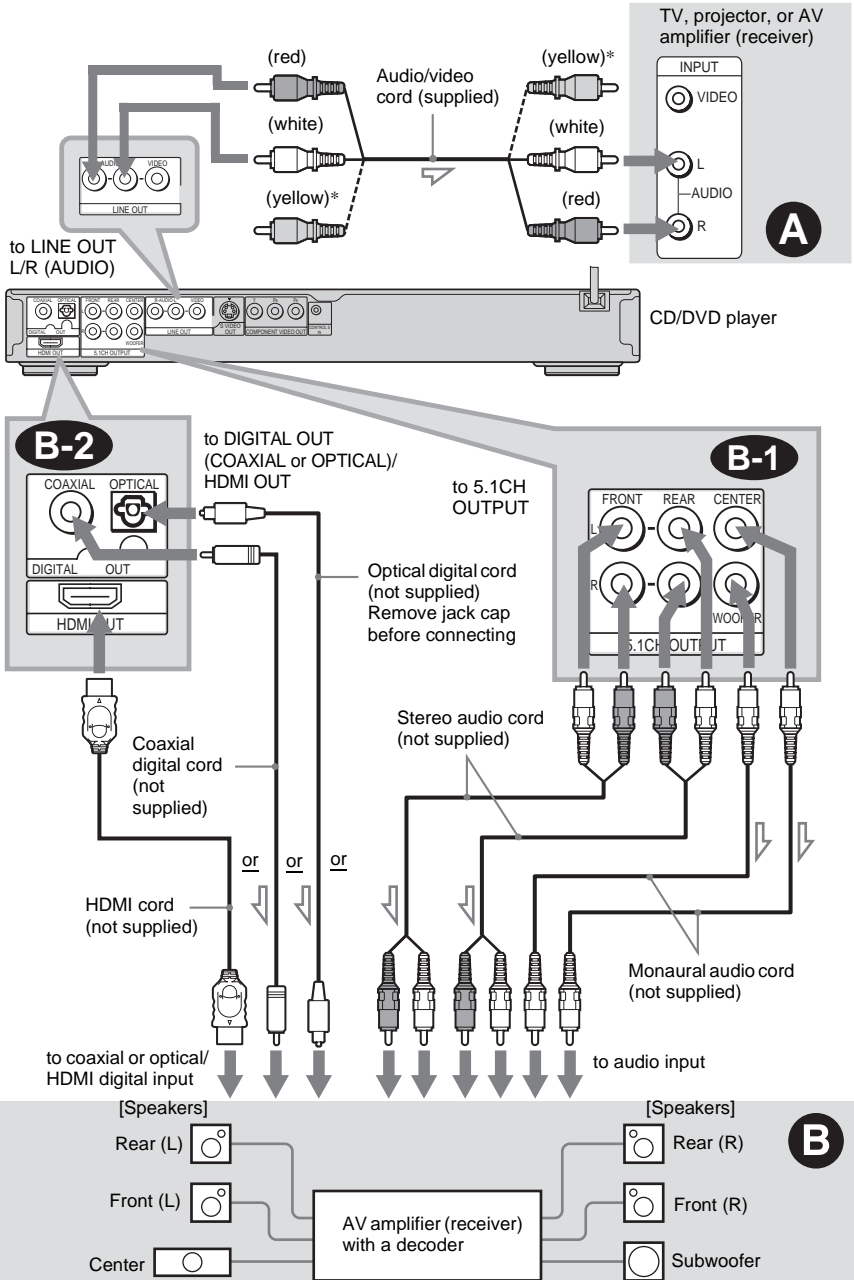

## A Connecting to audio L/R input jacks

This connection will use your TV's or stereo amplifier's (receiver's) two speakers for sound. Connect using the audio/video cord (supplied).

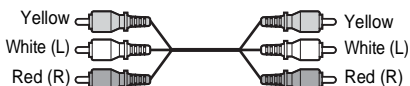

- Surround effect (page 47)  
TV: Dynamic Theater, Dynamic, Wide, Night



Stereo amplifier (receiver): Standard, Night

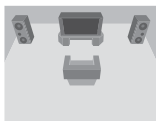

## B Connecting to an AV amplifier (receiver) with 5.1 ch input jacks and/or a digital audio input jack

If your AV amplifier (receiver) has 5.1 channel inputs, use **B-1**.

If you want to use the Dolby Digital\*<sup>1</sup>, or DTS\*<sup>2</sup> decoder function on your AV amplifier (receiver), connect to its digital jack using **B-2**. With the following connections, you can enjoy a more realistic audio presence in the comfort of your own home.

### B-1 : Connecting to the 5.1 ch input jacks

You can enjoy 5.1 ch surround sound using the internal Dolby Digital, DTS or Super Audio CD Multi decoder of this player. Connect using the stereo audio cord or monaural audio cord (not supplied).

#### Stereo audio cord

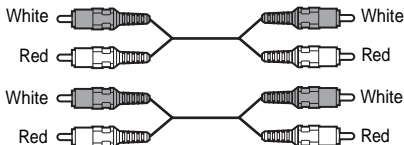

#### Monaural audio cord

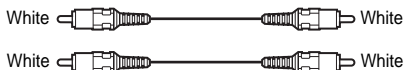

- Surround effect  
Dolby Digital (5.1ch), DTS (5.1ch), Super Audio CD Multi channel

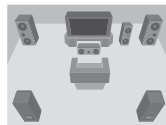

### B-2 : Connecting to a digital audio input jack

If your AV amplifier (receiver) has a Dolby Digital or DTS decoder and a digital input jack, use this connection.

Connect using a coaxial or optical digital cord/HDMI cord (not supplied).

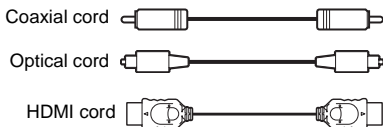

- Surround effect  
Dolby Digital (5.1ch), DTS (5.1ch)

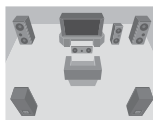

\*1 Manufactured under license from Dolby Laboratories. “Dolby,” “Pro Logic,” and the double-D symbol are trademarks of Dolby Laboratories.

\*2 Manufactured under license from Digital Theater Systems, Inc. U.S. Pat. No’s. 5,451,942; 5,956,674; 5,974,380; 5,978,762; 6,226,616; 6,487,535 and other U.S. and world-wide patents issued and pending. “DTS” and “DTS Digital Surround” are registered trademarks of Digital Theater Systems, Inc. Copyright 1996, 2003 Digital Theater Systems, Inc. All Rights Reserved.

## Hints

### • For connection **B-2**

- For correct speaker location, refer to the operating instructions of the connected components.
- To enhance the sound performance:
  - Use high-performance speakers.
  - Use front, rear, and center speakers of the same size and performance.
  - Place the subwoofer between the left and right front speakers.
- Use connection **B-2** when connecting to 7 or more speakers (6.1 ch or more).

## Notes

### For connection **B-2**

- After you have completed the connection, be sure to set “DOLBY DIGITAL” to “DOLBY DIGITAL” and “DTS” to “DTS” in Quick Setup (page 25).
- When you connect an amplifier (receiver) that conforms to the 96 kHz sampling frequency, set “48kHz/96kHz PCM” in “AUDIO SETUP” to “96kHz/24bit” (page 75).
- Super Audio CD audio signals are not output from the DIGITAL OUT (COAXIAL or OPTICAL)/HDMI OUT jack.
- The surround sound effects of this player cannot be used with this connection.
- When you connect the player to an AV amplifier (receiver) using an HDMI cord, you will need to do one of the following:
  - Connect the AV amplifier (receiver) to the TV with the HDMI cord.
  - Connect the player to the TV with a video cord other than HDMI cord (component video cord, S VIDEO cord, or audio/video cord).

## Step 5: Connecting the Power Cord

Plug the player and TV power cords into an AC outlet.

## Step 6: Quick Setup

Follow the steps below to make the minimum number of basic adjustments for using the player. To skip an adjustment, press **▶▶**. To return to the previous adjustment, press **◀◀**.

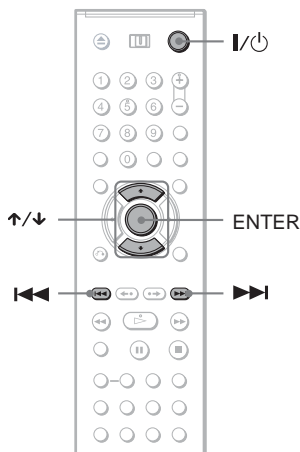

**1** Turn on the TV.

**2** Press **I/Power**.

**3** Switch the input selector on your TV so that the signal from the player appears on the TV screen.

“Press [ENTER] to run QUICK SETUP” (press enter to run Quick Setup) appears at the bottom of the screen. If this message does not appear, select “QUICK” under “SETUP” in the Control Menu to run Quick Setup (page 69).

**4** Press **ENTER** without inserting a disc.

The Setup Display for selecting the language used in the on-screen display appears.

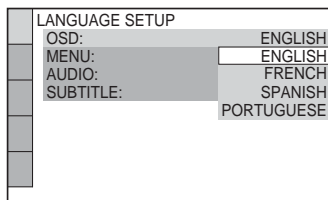

**5** Press **↑/↓** to select a language.

The player displays the menu and subtitles in the selected language.

## 6 Press ENTER.

The Setup Display for selecting the aspect ratio of the TV to be connected appears.

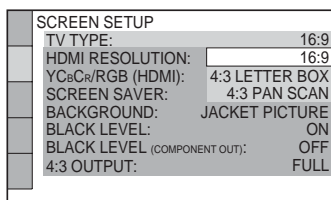

## 7 Press $\uparrow/\downarrow$ to select the setting that matches your TV type.

- ◆ If you have a 4:3 standard TV
  - 4:3 LETTER BOX or 4:3 PAN SCAN (page 70)
- ◆ If you have a wide-screen TV or a 4:3 standard TV with a wide-screen mode
  - 16:9 (page 70)

## 8 Press ENTER.

The Setup Display for selecting the type of jack used to connect your amplifier (receiver) appears.

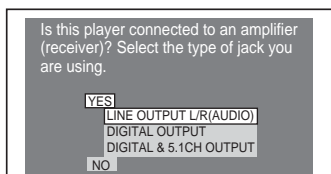

## 9 Press $\uparrow/\downarrow$ to select the type of jack (if any) you are using to connect to an amplifier (receiver), then press ENTER.

If you did not connect an AV amplifier (receiver), select “NO,” then go to step 19.

If you connected an AV amplifier (receiver) using just an audio cord, select “YES: LINE OUTPUT L/R (AUDIO),” then go to step 19.

If you connected an AV amplifier (receiver) using a digital coaxial or optical/HDMI cord, select “YES: DIGITAL OUTPUT.”

Setup Display for “DOLBY DIGITAL” appears.

If you connected an AV amplifier (receiver) using an audio cord, select “YES: DIGITAL & 5.1CH OUTPUT.” The Setup Display for “DOLBY DIGITAL” appears.

## 10 Press $\uparrow/\downarrow$ to select the type of Dolby Digital signal you wish to send to your amplifier (receiver).

If your AV amplifier (receiver) has a Dolby Digital decoder, select “DOLBY DIGITAL.” Otherwise, select “D-PCM.”

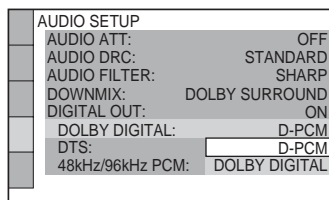

## 11 Press ENTER.

“DTS” is selected.

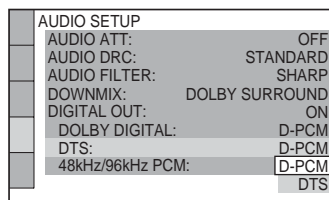

## 12 Press $\uparrow/\downarrow$ to select whether or not you wish to send a DTS signal to your amplifier (receiver).

If your AV amplifier (receiver) has a DTS decoder, select “DTS.” Otherwise, select “D-PCM.”

## 13 Press ENTER.

◆ When “DIGITAL OUTPUT” is selected in step 9

- Quick Setup is finished and connections are complete.

◆ When “DIGITAL & 5.1CH OUTPUT” is selected in step 9

- The Setup Display for “SPEAKER SETUP” appears.

## 14 Press $\uparrow/\downarrow$ to select the size of the center speaker.

If no center speaker is connected, select “NONE” (page 76).

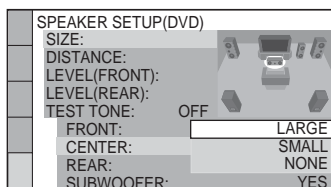

### Note

If you run Quick Setup, any settings stored by “PLAYBACK MEMORY” in “CUSTOM SETUP” (page 72) may return to the default settings.

## 15 Press ENTER.

“REAR” is selected.

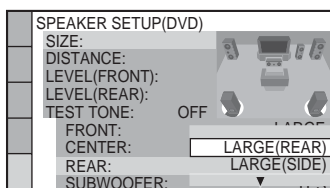

## 16 Press $\uparrow/\downarrow$ to select the size of the rear speakers.

If no rear speaker is connected, select “NONE.”

## 17 Press ENTER.

“SUBWOOFER” is selected.

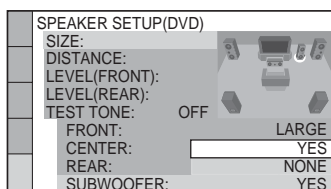

## 18 Press $\uparrow/\downarrow$ to select whether or not you have connected a subwoofer.

## 19 Press ENTER.

Quick Setup is finished. All connections and setup operations are complete.

## Playing Discs

### Playing Discs **DVDVideo** **DVDVR**

**VCD** **CD<sup>Super</sup>** **CD** **DATA CD**

**DATA DVD**

Depending on the DVD or VIDEO CD, some operations may be different or restricted. Refer to the operating instructions supplied with your disc.

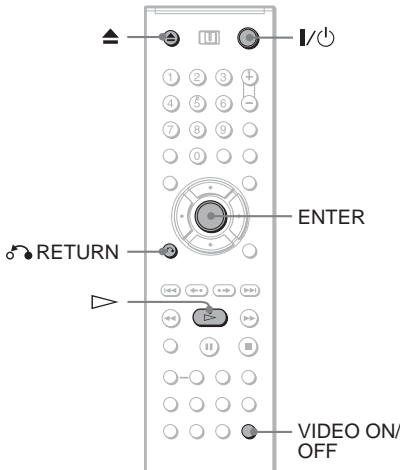
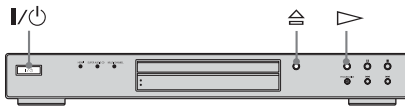

**1** Turn on your TV.

**2** Press **I/⏻**.

The player turns on.

**3** Switch the input selector on your TV so that the signal from the player appears on the TV screen.

◆ **When using an amplifier (receiver)**

Turn on the amplifier (receiver) and select the appropriate channel so that you can hear sound from the player.

**4** Press **⏻** on the player, and place a disc on the disc tray.

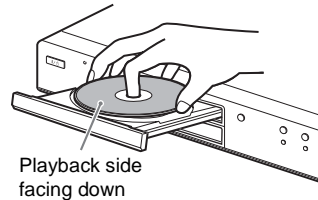

**5** Press **▶**.

The disc tray closes. The player starts playback (continuous play). Adjust the volume on the TV or the amplifier (receiver).

Depending on the disc, a menu may appear on the TV screen. For DVD VIDEOS, see page 31. For VIDEO CDs, see page 33.

### To enjoy the clarity of Super Audio CD/CD sound more

You can minimize the effect of the video output by switching it off.

Press VIDEO ON/OFF, so that the VIDEO OFF indicator lights up on the player.

To cancel the setting, press VIDEO ON/OFF again.

### To turn off the player

Press **I/⏻**. The player enters standby mode.

#### **💡 Hint**

You can have the player turn off automatically whenever you leave it in stop mode for more than 30 minutes. To turn this function on or off, set "AUTO POWER OFF" in "CUSTOM SETUP" to "ON" or "OFF" (page 72).

#### **Notes**

- Discs created on DVD recorders must be correctly finalized before they can be played. For more information about finalizing, refer to the operating instructions supplied with the DVD recorder.
- Super Audio CD audio signals are not output from the DIGITAL OUT (COAXIAL or OPTICAL)/HDMI OUT jacks.
- The VIDEO ON/OFF function is not effective when you use the HDMI connection.

## Additional operations

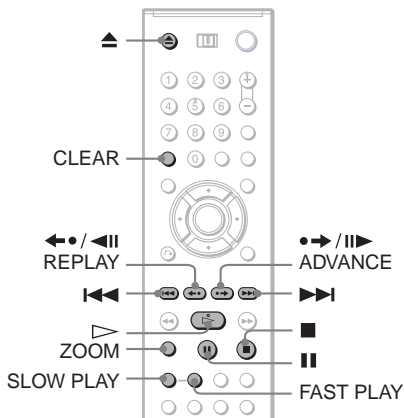

To	Operation
Stop	Press ■
Pause	Press ■■
Resume play after pause	Press ■■ or ▷
Go to the next chapter, track or scene in continuous play mode	Press ►►►
Go back to the previous chapter, track or scene in continuous play mode	Press ◀◀◀
Stop play and remove the disc	Press ▲
Replay the previous scene* <sup>1</sup>	Press ◀◀◀ ◀◀◀ REPLAY during playback
Briefly fast forward the current scene* <sup>2</sup>	Press ►►► ►►► ADVANCE during playback
Magnify the image* <sup>3</sup>	Press ZOOM repeatedly. Press CLEAR to cancel.

\*<sup>1</sup> DVD VIDEOS/DVD-RWs/DVD-Rs only

\*<sup>2</sup> DVD VIDEOS/DVD-RWs/DVD-Rs/  
DVD+RWs/DVD+Rs only

\*<sup>3</sup> Video and JPEG pictures only (except BACKGROUND pictures). You can move the enlarged picture using ◀/↑/↓/→. Depending upon the contents of the disc, the zoom function may be canceled automatically when the picture is moved.

## Note

You may not be able to use the Replay or Advance function with some scenes.

## Playback quickly or slowly with sound

You can listen to dialog or sound while playing the current scene quickly or slowly.

### During playback, press FAST PLAY or SLOW PLAY.

The speed changes when you press either FAST PLAY or SLOW PLAY.

### To return to normal playback

Press ▷.

## Notes

- You can only use this function with DVDs/VIDEO CDs/Super VCDs and DVD-RWs/DVD-Rs in VR mode only.
- “Operation not possible” will appear when maximum or minimum speed is reached.
- During Fast Play or Slow Play mode, you cannot change the angle (page 50), subtitle (page 50), or sound (page 45). The sound can only be changed for VIDEO CDs/Super VCDs.
- Fast Play and Slow Play functions do not work when playing DTS sound tracks.
- You cannot use Fast Play or Slow Play functions when playing a still picture on DVD-RW/DVD-R in VR mode.

## Locking the disc tray (Child Lock)

You can lock the disc tray to prevent children from opening it.

When the player is in standby mode, press ⏪ RETURN, ENTER and then I/⏻ on the remote.

The player turns on and “LOCKED” appears on the front panel display. The ▲ and ▼ buttons on the player or the remote do not work while the Child Lock is set.

### To unlock the disc tray

When the player is in standby mode, press ⏪ RETURN, ENTER and then I/⏻ again.

## Note

Even if you select “RESET” under “SETUP” in the Control Menu (page 69), the disc tray remains locked.

# Resuming Playback From the Point Where You Stopped the Disc (Multi-disc Resume)

**DVDVideo** **VCD**

The player stores the point where you stopped the disc for up to 40 discs and resumes playback the next time you insert the same disc. If you store a resume playback point for the 41st disc, the resume playback point for the first disc is deleted.

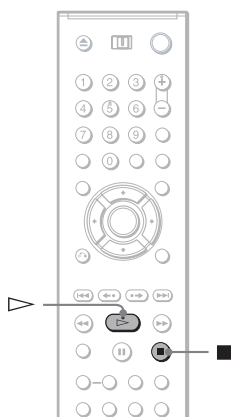

## 1 While playing a disc, press ■ to stop playback.

“RESUME” appears on the front panel display.

## 2 Press ▷.

The player starts playback from the point where you stopped the disc in step 1.

### Hint

To play from the beginning of the disc, press ■ twice, then press ▷.

### Notes

- “MULTI-DISC RESUME” in “CUSTOM SETUP” must be set to “ON” (default) for this function to work (page 73).
- The point where you stopped playing is cleared when:
  - you change the play mode.
  - you change the settings on the Setup Display.
- For DVD-RWs/DVD-Rs in VR mode, CDs, Super Audio CDs, DATA CDs, and DATA DVDs the player remembers the resume playback point for the current disc.

The resume point is cleared when:

  - you opened the disc tray.
  - you disconnect the power cord (Super Audio CD, CD or DATA CD/DATA DVD only).
  - the player enters standby mode (DATA CD/DATA DVD only).
- Resume Play does not work during Shuffle Play and Program Play.
- This function may not work with some discs.
- If “MULTI-DISC RESUME” in “CUSTOM SETUP” is set to “ON” and you playback a recorded disc such as DVD-RW, the player may playback other recorded discs from the same resume point. To play from the beginning, press ■ twice and then press ▷.

## Using the DVD's Menu

**DVD**Video

A DVD is divided into long sections of a picture or a music feature called "titles." When you play a DVD which contains several titles, you can select the title you want using the TOP MENU button. When you play DVDs that allow you to select items such as language for the sound and subtitles, select these items using the MENU button.

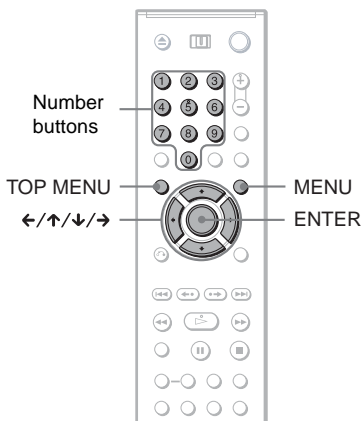

**1** Press TOP MENU or MENU.  
The disc's menu appears on the TV screen. The contents of the menu vary from disc to disc.

**2** Press ←/↑/↓/→ or the number buttons to select the item you want to play or change.  
If you press the number buttons, the following display appears. Press the number buttons to select the item you want.



**3** Press ENTER.

## Selecting "ORIGINAL" or "PLAY LIST" on a DVD-RW/DVD-R

**DVD**VR

Some DVD-RWs/DVD-Rs in VR (Video Recording) mode have two types of titles for playback: originally recorded titles (ORIGINAL) and titles that can be created on recordable DVD players for editing (PLAY LIST). You can select the type of title to be played.

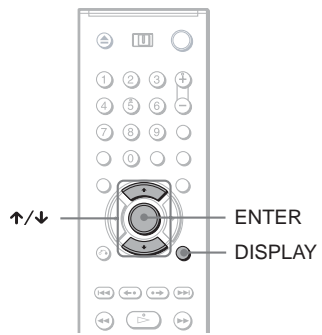

**1** Press DISPLAY when the player is in stop mode.  
The Control Menu appears.

**2** Press ↑/↓ to select  (ORIGINAL/PLAY LIST), then press ENTER.  
The options for "ORIGINAL/PLAY LIST" appear.

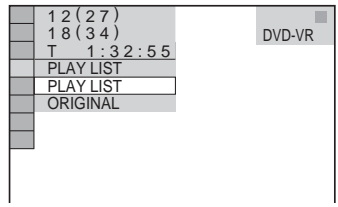

**3** Press ↑/↓ to select a setting.

- PLAY LIST: plays the titles created from "ORIGINAL" for editing.
- ORIGINAL: plays the titles originally recorded.

**4** Press ENTER.

---

## Selecting a Playback Area for a Super Audio CD

CD **CD<sup>Super</sup>**

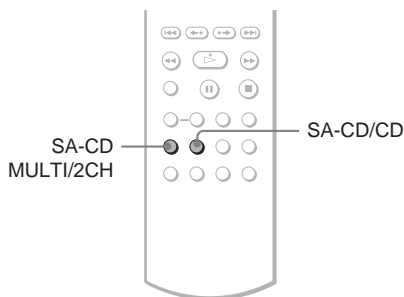

---

## Selecting a playback area on a 2 channel + Multi-channel Super Audio CD

Some Super Audio CDs consist of a 2 channel playback area and a multi-channel playback area. You can select the playback area you want to listen to.

- 1 Press SA-CD MULTI/2CH when the player is in stop mode.

The following display appears.

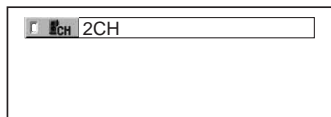

- 2 Press SA-CD MULTI/2CH repeatedly to select the item.

- MULTI: plays a multi-channel playback area.
- 2CH: plays a 2 channel playback area.

The MULTI CHANNEL indicator in the front panel display lights up when playing a multi-channel playback area.

---

---

## Selecting a playback layer when playing a hybrid Super Audio CD

Some Super Audio CDs consist of an HD layer and a CD layer. You can select the playback layer you want to listen to.

Press SA-CD/CD when the player is in stop mode.

Each time you press the button, an HD layer or a CD layer is alternately selected. When playing a CD layer, the “CD” indicator in the front panel display lights up.

---

### Notes

- For details about Super Audio CD discs, see page 83.
- Each play mode function works only within the selected layer or playback area.

# Playing VIDEO CDs With PBC Functions (PBC Playback)

## VCD

PBC (Playback Control) allows you to play VIDEO CDs interactively by following the menu on the TV screen.

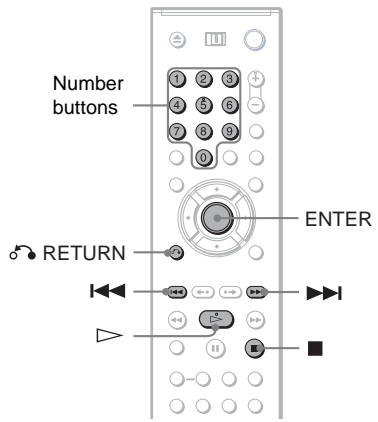

- 1** Start playing a VIDEO CD with PBC functions.  
The menu for your selection appears.
- 2** Press the number buttons to select the item number you want.
- 3** Press ENTER.
- 4** Follow the instructions in the menu for interactive operations.  
Refer to the instructions supplied with the disc, as the operating procedure may differ depending on the VIDEO CD.

**To return to the menu**  
Press RETURN.

**Hint**  
To play without using PBC, press ◀▶ or the number buttons while the player is stopped to select a track, then press ▷ or ENTER.  
“Play without PBC” appears on the TV screen and the player starts continuous play. You cannot play still pictures such as a menu.  
To return to PBC playback, press ■ twice then press ▷.

**Note**  
Depending on the VIDEO CD, “Press ENTER” in step 3 may appear as “Press SELECT” in the instructions supplied with the disc. In this case, press ▷.

# Various Play Mode Functions (Program Play,

## Shuffle Play, Repeat Play, A-B Repeat Play)

You can set the following play modes:

- Program Play (page 34)
- Shuffle Play (page 36)
- Repeat Play (page 36)
- A-B Repeat Play (page 37)

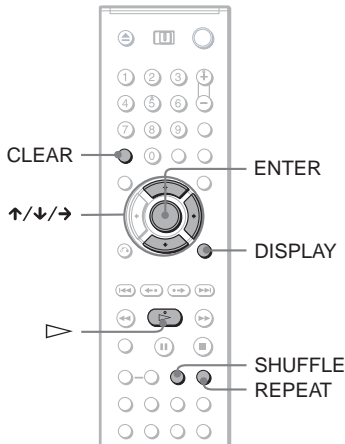

### Note

- The play mode is canceled when:
- you open the disc tray.
  - the player enters standby mode by pressing .

# Creating your own program (Program Play)

**DVDVideo VCD CD<sup>Super</sup>**

## CD

You can play the contents of a disc in the order you want by arranging the order of the titles, chapters or tracks on the disc to create your own program. You can program up to 99 titles, chapters and tracks.

### 1 Press DISPLAY.

The Control Menu appears.

### 2 Press to select (PROGRAM), then press ENTER.

The options for "PROGRAM" appear.

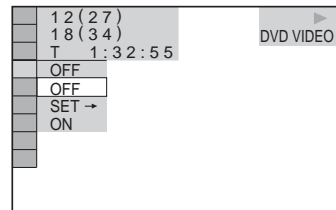

### 3 Press to select "SET →," then press ENTER.

"TRACK" is displayed when you play a VIDEO CD, Super Audio CD or CD.

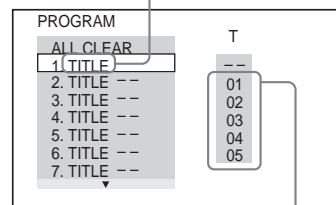

Titles or tracks recorded on a disc

### 4 Press .

The cursor moves to the title or track row "T" (in this case, "01").

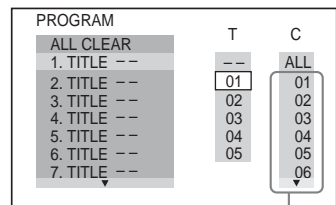

Chapters recorded on a disc

## 5 Select the title, chapter or track you want to program.

### ◆ When playing a DVD VIDEO

For example, select chapter "03" of title "02."

Press  $\uparrow/\downarrow$  to select "02" under "T," then press ENTER.

PROGRAM		T	C
ALL CLEAR		--	ALL
1. TITLE --		01	01
2. TITLE --		02	02
3. TITLE --		03	03
4. TITLE --		04	04
5. TITLE --		05	05
6. TITLE --			06
7. TITLE --			

Next, press  $\uparrow/\downarrow$  to select "03" under "C," then press ENTER.

PROGRAM		T
ALL CLEAR		--
1. TITLE (02-03)		01
2. TITLE --		02
3. TITLE --		03
4. TITLE --		04
5. TITLE --		05
6. TITLE --		
7. TITLE --		

Selected title and chapter

### ◆ When playing a VIDEO CD, Super Audio CD or CD

For example, select track "02."

Press  $\uparrow/\downarrow$  to select "02" under "T," then press ENTER. The track number may be displayed in 3 digits for a Super Audio CD.

Selected track

PROGRAM		T
ALL CLEAR		--
1. TRACK (02)		01
2. TRACK --		02
3. TRACK --		03
4. TRACK --		04
5. TRACK --		05
6. TRACK --		
7. TRACK --		

Total time of the programmed tracks

## 6 To program other titles, chapters or tracks, repeat steps 4 to 5.

The programmed titles, chapters and tracks are displayed in the selected order.

## 7 Press $\triangleright$ to start Program Play.

Program Play begins.

When the program ends, you can restart the same program again by pressing  $\triangleright$ .

### To return to normal play

Press CLEAR or select "OFF" in step 3. To play the same program again, select "ON" in step 3 and press ENTER.

### To change or cancel a program

- 1 Follow steps 1 to 3 of "Creating your own program (Program Play)."
- 2 Select the program number of the title, chapter or track you want to change or cancel using  $\uparrow/\downarrow$  and press  $\rightarrow$ . If you want to delete the title, chapter or track from the program, press CLEAR.
- 3 Follow step 5 for new programming. To cancel a program, select "--" under "T," then press ENTER.

### To cancel all of the titles, chapters or tracks in the programmed order

- 1 Follow steps 1 to 3 of "Creating your own program (Program Play)."
- 2 Press  $\uparrow$  and select "ALL CLEAR."
- 3 Press ENTER.

### 🔔 Hint

You can perform Repeat Play or Shuffle Play of programmed titles, chapters or tracks. During Program Play, follow the steps of Repeat Play (page 36) or Shuffle Play (page 36).

### Notes

- When you program tracks on a Super VCD, the total playing time is not displayed.
- You cannot use this function with VIDEO CDs or Super VCDs with PBC playback.

---

## Playing in random order (Shuffle Play)

**DVDVideo VCD CD<sup>Super</sup> CD**

You can have the player “shuffle” titles, chapters or tracks. Subsequent “shuffling” may produce a different playing order.

### 1 Press SHUFFLE during playback.

The following display appears.

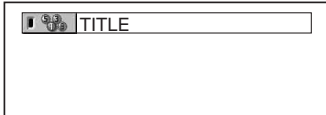

### 2 Press SHUFFLE repeatedly to select the item to be shuffled.

- ◆ When playing a DVD VIDEO
  - TITLE
  - CHAPTER
- ◆ When playing a VIDEO CD, Super Audio CD or CD
  - TRACK
- ◆ When Program Play is activated
  - ON: shuffles titles, chapters or tracks selected in Program Play.

---

### To return to normal play

Press CLEAR or select “OFF” in step 2.

#### Hints

- You can set Shuffle Play while the player is stopped. After selecting the “SHUFFLE” option, press . Shuffle Play starts.
- Up to 200 chapters in a disc can be played in random order when “CHAPTER” is selected.

#### **Note**

You cannot use this function with VIDEO CDs or Super VCDs with PBC playback.

---

## Playing repeatedly (Repeat Play)

**DVDVideo DVDVR VCD CD<sup>Super</sup> CD DATA CD**

**DATA DVD**

You can play all of the titles or tracks on a disc, or a single title, chapter or track repeatedly.

You can use a combination of Shuffle or Program Play modes.

### 1 Press REPEAT during playback.

The following display appears.

### 2 Press REPEAT repeatedly to select the item to be repeated.

- ◆ When playing a DVD VIDEO
  - DISC: repeats all of the titles.
  - TITLE: repeats the current title on a disc.
  - CHAPTER: repeats the current chapter.
- ◆ When playing a DVD-VR mode disc
  - DISC: repeats all the titles of the selected type.
  - TITLE: repeats the current title on a disc.
  - CHAPTER: repeats the current chapter.
- ◆ When playing a VIDEO CD, Super Audio CD or CD
  - DISC: repeats all of the tracks.
  - TRACK: repeats the current track.
- ◆ When playing a DATA CD or DATA DVD with MP3 audio tracks or JPEG image files
  - DISC: repeats all of the albums.
  - ALBUM: repeats the current album.
  - TRACK (MP3 audio tracks only): repeats the current track.
- ◆ When Program Play or Shuffle Play is activated
  - ON: repeats Program Play or Shuffle Play.

---

### To return to normal play

Press CLEAR or select “OFF” in step 2.

#### Hint

You can set Repeat Play while the player is stopped. After selecting the “REPEAT” option, press . Repeat Play starts.

**Notes**

- You cannot use this function with VIDEO CDs or Super VCDs with PBC playback.
- When repeating a DATA CD/DATA DVD which contains MP3 audio tracks and JPEG image files, and their playing times are not the same, the sound will not match the image.
- When “MODE (MP3, JPEG)” is set to “IMAGE (JPEG)” (page 60), you cannot select “TRACK.”

## Repeating a specific portion (A-B Repeat Play)

**DVD**Video **DVD**VR **VCD** **CD**

You can play a specific portion of a title, chapter or track repeatedly. (This function is useful when you want to memorize lyrics, etc.)

### 1 Press DISPLAY during playback.

The Control Menu appears.

### 2 Press $\uparrow/\downarrow$ to select (A-B REPEAT), then press ENTER.

The options for “A-B REPEAT” appear.

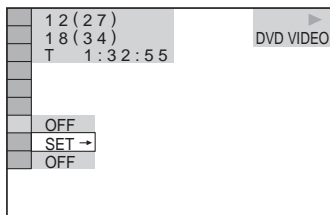

### 3 Press $\uparrow/\downarrow$ to select “SET →,” then press ENTER.

The “A-B REPEAT” setting bar appears.

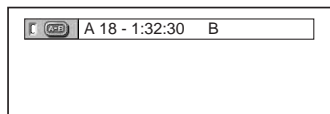

### 4 During playback, when you find the starting point (point A) of the portion to be played repeatedly, press ENTER.

The starting point (point A) is set.

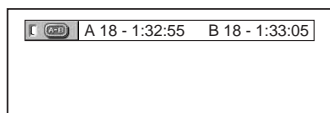

### 5 When you reach the ending point (point B), press ENTER again.

The set points are displayed and the player starts repeating this specific portion.

### To return to normal play

Press CLEAR or select “OFF” in step 3.

**Notes**

- When you set A-B Repeat Play, the settings for Shuffle Play, Repeat Play and Program Play are canceled.
- A-B Repeat Play does not work across multiple titles.
- You may not set A-B Repeat Play for contents on a DVD-RW/DVD-R (VR mode) that contains still pictures.

## Searching for a Scene

# Searching for a Particular Point on a Disc (Search, Scan, Slow-motion Play, Freeze Frame)

You can quickly locate a particular point on a disc by monitoring the picture or playing back slowly.

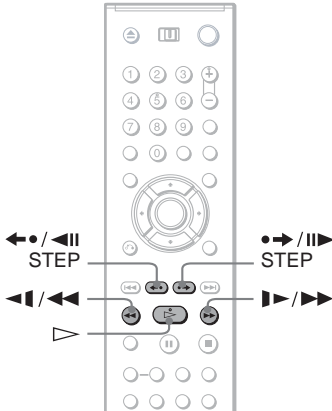

### Notes

- Depending on the disc, you may not be able to do some of the operations described.
- For DATA CDs/DATA DVDs, you can search for a particular point only on an MP3 audio track.

## Locating a point quickly using the PREV (previous)/NEXT (next) buttons (Search)

DVDVideo DVDVR VCD CDSuper CD DATA CD  
DATA DVD

You can search for the next or previous chapter, track or scene using **◀◀/▶▶** on the player.

During playback, press **▶▶** or **◀◀** once briefly to go to the next or previous chapter/track/scene. Or, press and hold **▶▶** or **◀◀** to search forward or backwards and release the button when you find the point you want to return to normal playback. (Search)

## Locating a point quickly by playing a disc in fast forward or fast reverse (Scan)

DVDVideo DVDVR VCD CDSuper CD DATA CD  
DATA DVD

Press **◀◀◀◀** or **▶▶▶▶** while playing a disc. When you find the point you want, press **▷** to return to normal speed. Each time you press **◀◀◀◀** or **▶▶▶▶** during scan, the scan speed changes. With each press the indication changes as shown below. Actual speeds may differ between discs.

### Playback direction

×2▶ → 1▶▶ → 2▶▶▶ → 3▶▶▶▶

3▶▶▶▶ (DVD VIDEO/DVD-VR mode/  
VIDEO CD only)  
×2▶▶▶▶ (DVD VIDEO/Super Audio CD/  
CD only)

### Opposite direction

×2◀ ← 1◀◀ ← 2◀◀◀ ← 3◀◀◀◀

3◀◀◀◀ (DVD VIDEO/DVD-VR mode/  
VIDEO CD only)  
×2◀◀◀◀ (DVD VIDEO only)

The “×2▶”/“×2◀” playback speed is about twice the normal speed.

The “3▶▶▶”/“3◀◀◀” playback speed is faster than “2▶▶▶”/“2◀◀◀” and the “2▶▶▶”/“2◀◀◀” playback speed is faster than “1▶▶▶”/“1◀◀◀”.

## Watching frame by frame (Slow-motion Play)

DVDVideo DVDVR VCD

Press ◀◀ or ▶▶ when the player is in pause mode. To return to normal speed, press ▷.

Each time you press ◀◀ or ▶▶ during Slow-motion Play, the playback speed changes. Two speeds are available. With each press the indication changes as follows:

Playback direction

2 ▶▶ ↔ 1 ▶▶

Opposite direction (DVD/DVD-VR mode only)

2 ◀◀ ↔ 1 ◀◀

The “2 ▶▶”/“2 ◀◀” playback speed is slower than “1 ▶▶”/“1 ◀◀.”

## Playing one frame at a time (Freeze Frame)

DVDVideo DVDVR VCD

When the player is in the pause mode, press ●→ ||▶ STEP to go to the next frame. Press ◀● ◀|| STEP to go to the preceding frame (DVD/DVD-VR mode only). To return to normal playback, press ▷.

### Note

You cannot search for a still picture on a DVD-RW/DVD-R in VR mode.

## Searching for a Title/Chapter/Track/Scene, etc. (Search mode)

DVDVideo DVDVR VCD CDSuper CD

DATA CD DATA DVD

You can search a DVD by title or chapter, and you can search a VIDEO CD/Super Audio CD/CD/DATA CD/DATA DVD by track, index or scene. As titles and tracks are assigned unique numbers on the disc, you can select the desired one by entering its number. You can also search for a scene using the time code.

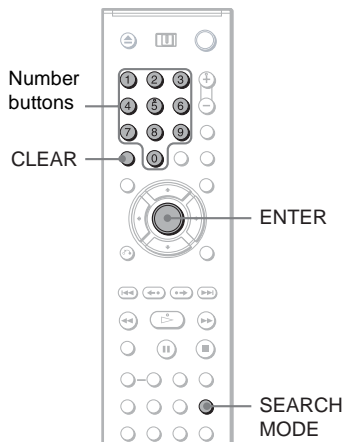

### 1 Press SEARCH MODE.

The following display appears. “-- (\*\*)” appears next to the icon (\*\* refers to a number). The number in parentheses indicates the total number of titles, tracks, indexes, scenes, etc., of the disc.

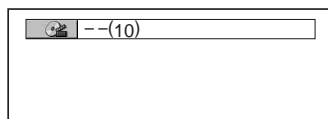

### 2 Press SEARCH MODE repeatedly to select a search method.

◆ When playing a DVD VIDEO/DVD-VR mode disc



TITLE



CHAPTER



TIME/TEXT

Select “TIME/TEXT” to search for a starting point by inputting the time code.

◆ When playing a VIDEO CD or Super VCD without PBC Playback



TRACK



INDEX

◆ When playing a VIDEO CD or Super VCD with PBC Playback



SCENE

◆ When playing a Super Audio CD/CD



TRACK

◆ When playing a DATA CD/DATA DVD



ALBUM



TRACK (MP3 audio tracks only)



FILE (JPEG image files only)

**3** Select the number of the title, track, scene, time code, etc. you want by pressing the number buttons to select the digit.

◆ When you select  TIME/TEXT

For example, to find the scene at 2 hours, 10 minutes, and 20 seconds after the beginning, enter “21020.”

◆ If you make a mistake

Cancel the number by pressing CLEAR, then select another number.

**4** Press ENTER.

The player starts playback from the selected number.

**To turn off the display**

Press SEARCH MODE repeatedly until the display is turned off.

 **Hints**

- When the Control Menu display is turned off, you can search for a chapter (DVD VIDEO/DVD-VR mode) or track (Super Audio CD/CD/DATA CD/DATA DVD) by pressing the number buttons and ENTER.
- You can display the first scene of titles, chapters or tracks recorded on the disc on a screen divided into 9 sections. You can start playback directly by selecting one of the scenes. For details, see “Searching by Scene (PICTURE NAVIGATION)” (page 41).

**Notes**

- The title, chapter or track number displayed is the same number recorded on the disc.
- You cannot search for a scene on a DVD+RW/DVD+R using the time code.

# Searching by Scene

(PICTURE NAVIGATION) DVDVideo VCD

You can divide the screen into 9 subscreens and find the desired scene quickly.

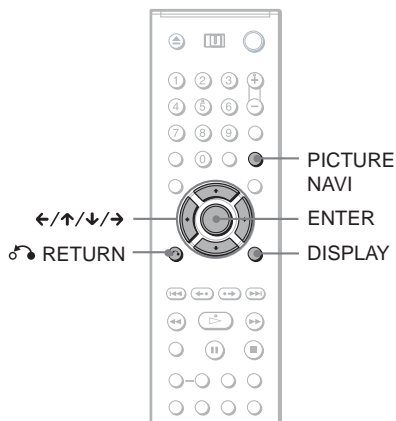

## 1 Press PICTURE NAVI during playback.

The following display appears.

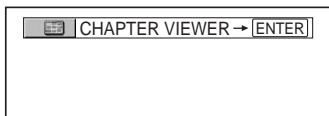

## 2 Press PICTURE NAVI repeatedly to select an item.

- CHAPTER VIEWER (DVD VIDEO only): displays the first scene of each chapter.
- TITLE VIEWER (DVD VIDEO only): displays the first scene of each title.
- TRACK VIEWER (VIDEO CD/ Super VCD only): displays the first scene of each track.

## 3 Press ENTER.

The first scene of each chapter, title or track appears as follows.

1	2	3	
4	5	6	
7	8	9	▼

## 4 Press ←/↑/↓/→ to select a chapter, title or track, and press ENTER.

Playback starts from the selected scene.

### To return to normal play during setting

Press ↶ RETURN or DISPLAY.

#### 💡 Hint

If there are more than 9 chapters, titles or tracks, ▼ is displayed at the bottom right of the screen. To display the additional chapters, titles or tracks, select the bottom scenes and press ↓. To return to the previous scene, select the top scenes and press ↑.

#### Note

Depending on the disc, you may not be able to select some items.

## Viewing Information About the Disc

# Checking the Playing Time and Remaining Time

**DVD**Video **DVD**VR **VCD** **CD**Super

**CD** **DATA CD** **DATA DVD**

You can check the playing time and remaining time of the current title, chapter or track. Also, you can check the DVD/Super Audio CD/CD text or track name (MP3 audio) recorded on the disc.

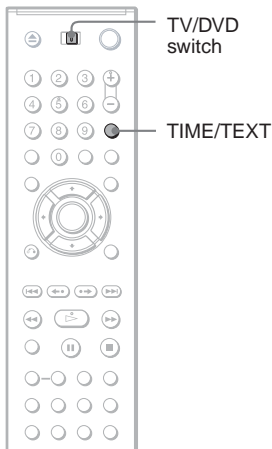

- 1 Make sure that the TV/DVD switch is set to DVD. Press TIME/TEXT during playback.

The following display appears.

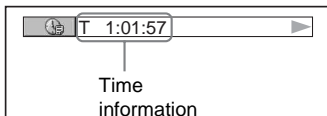

- 2 Press TIME/TEXT repeatedly to change the time information.

The available time information depends upon the type of disc you are playing.

### ◆ When playing a DVD VIDEO or DVD-VR mode disc

- T \*:\*: (hours: minutes: seconds)  
Playing time of the current title
- T-\*:\*:  
Remaining time of the current title
- C \*:\*:  
Playing time of the current chapter
- C-\*:\*:  
Remaining time of the current chapter

### ◆ When playing a VIDEO CD or Super VCD (with PBC functions)

- \*:\* (minutes: seconds)  
Playing time of the current scene

### ◆ When playing a VIDEO CD (without PBC functions), Super Audio CD or CD

- T \*:\* (minutes: seconds)  
Playing time of the current track
- T-\*:\*  
Remaining time of the current track
- D \*:\*:  
Playing time of the current disc
- D-\*:\*:  
Remaining time of the current disc

### ◆ When playing a Super VCD (without PBC functions)

- T \*:\* (minutes: seconds)  
Playing time of the current track

### ◆ When playing a DATA CD or DATA DVD (MP3 audio)

- T \*:\* (minutes: seconds)  
Playing time of the current track

## Checking the playing information of the disc

### To check the DVD/Super Audio CD/CD text

Press TIME/TEXT repeatedly in step 2 to display text recorded on the DVD/Super Audio CD/CD.

The DVD/Super Audio CD/CD text appears only when text is recorded in the disc. You cannot change the text. If the disc does not contain text, "NO TEXT" appears.

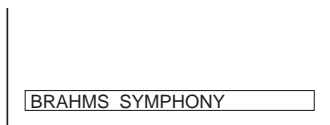

### To check DATA CD/DATA DVD (MP3 audio) album name, etc.

By pressing TIME/TEXT while playing MP3 audio tracks on a DATA CD/DATA DVD, you can display the name of the album/track and the audio bit rate (the amount of data per second of the current audio track) on your TV screen.

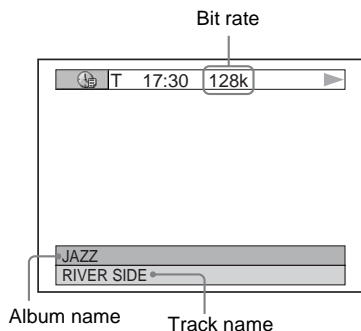

## Checking the information on the front panel display

You can view the time information and text displayed on the TV screen also on the front panel display. The information on the front panel display changes as follows when you change the time information on your TV screen.

### When playing a DVD VIDEO or DVD-VR mode disc

Playing time of the current title

T 10324



Remaining time of the current title

T-11536



Playing time of the current chapter

C 02230



Remaining time of the current chapter

C-01320



Text

SONY HI



Current title and chapter number

T 16 B

(returns to top automatically)

## When playing a DATA CD/DATA DVD (MP3 audio)

Playing time and number of the current track

6 2:25



Track name

0 IHAPPY



Current album and track number

1 6

(returns to top automatically)

## When playing a VIDEO CD (without PBC functions), Super Audio CD or CD

Playing time and number of the current track

3 2:25



Remaining time of the current track\*<sup>1</sup>

3 - 1:50



Playing time of the disc

32:12



Remaining time of the disc

-20:18



Text

SONY HI



Current track and index\*<sup>2</sup>

3 1

(returns to top automatically)

## Hints

- When playing VIDEO CDs without PBC functions, the track number and the index number are displayed after the text.
- When playing VIDEO CDs with PBC functions, the scene number or the playing time are displayed.
- Long text that does not fit in a single line will scroll across the front panel display.
- You can also check the time information and text using the Control Menu (page 14).

## Notes

- Depending on the type of disc being played, the disc text or track name may not be displayed.
- The player can only display the first level of the disc text, such as the disc name or title.
- Playing time of MP3 audio tracks may not be displayed correctly.
- If you play a disc containing JPEG image files only, "NO AUDIO DATA" appears when "MODE (MP3, JPEG)" is set to "AUTO," "JPEG" appears when "MODE (MP3, JPEG)" is set to "IMAGE (JPEG)" in the front panel display.

\*<sup>1</sup> When playing a Super Audio CD, the current track is not displayed.

\*<sup>2</sup> The current track and index appear only when playing a VIDEO CD or Super Audio CD.

## Sound Adjustments

### Changing the Sound

DVD Video DVD VR VCD CD DATA CD

DATA DVD

When playing a DVD VIDEO recorded in multiple audio formats (PCM, Dolby Digital or DTS), you can change the audio format. If the DVD VIDEO is recorded with multilingual tracks, you can also change the language.

With CDs, DATA CDs, DATA DVDs or VIDEO CDs, you can select the sound from either the right or left channel and listen to the sound of the selected channel through both the right and left speakers. For example, when playing a disc containing a song with the vocals on the right channel and the instruments on the left channel, you can hear the instruments from both speakers by selecting the left channel.

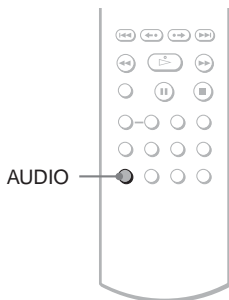

#### 1 Press AUDIO during playback.

The following display appears.

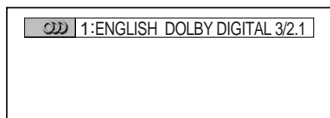

#### 2 Press AUDIO repeatedly to select the desired audio signal.

#### ◆ When playing a DVD VIDEO

Depending on the DVD VIDEO, the choice of language varies.

When 4 digits are displayed, they indicate a language code. See “Language Code List” on page 85 to see which language the code represents. When the same language is displayed two or more times, the DVD VIDEO is recorded in multiple audio formats.

#### ◆ When playing a DVD-VR mode disc

The types of sound tracks recorded on a disc are displayed. The default setting is underlined.

Example:

- 1: MAIN (main sound)
- 1: SUB (sub sound)
- 1: MAIN+SUB (main and sub sound)

#### ◆ When playing a VIDEO CD, CD or DATA CD/DATA DVD (MP3 audio)

The default setting is underlined.

- STEREO: the standard stereo sound
- 1/L: the sound of the left channel (monaural)
- 2/R: the sound of the right channel (monaural)

#### ◆ When playing a Super VCD

The default setting is underlined.

- 1:STEREO: the stereo sound of the audio track 1
- 1:1/L: the sound of the left channel of the audio track 1 (monaural)
- 1:2/R: the sound of the right channel of the audio track 1 (monaural)
- 2:STEREO: the stereo sound of the audio track 2
- 2:1/L: the sound of the left channel of the audio track 2 (monaural)
- 2:2/R: the sound of the right channel of the audio track 2 (monaural)

#### Notes

- While playing a Super VCD on which the audio track 2 is not recorded, no sound will come out when you select “2:STEREO,” “2:1/L,” or “2:2/R.”
- You cannot change the sound for Super Audio CDs.
- When playing DVD-RW/DVD-R in VR mode: If you connected to an AV amplifier (receiver) using the DIGITAL OUT (COAXIAL or OPTICAL)/HDMI OUT jack and want to switch between the sound tracks, set “DOLBY DIGITAL” to “D-PCM” in “AUDIO SETUP.”

## Checking the audio signal format **DVDVideo**

You can check the audio signal format by pressing **AUDIO** repeatedly during playback. The format of the current audio signal (Dolby Digital, DTS, PCM, etc.) appears as shown below.

### Example:

Dolby Digital 5.1 ch

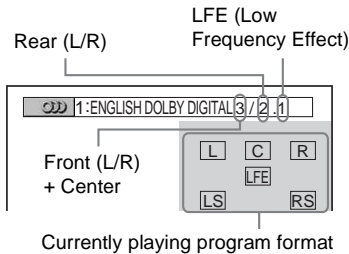

### Example:

Dolby Digital 3 ch

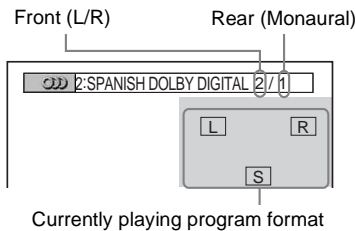

## About audio signals

Audio signals recorded in a disc contain the sound elements (channels) shown below. Each channel is output from a separate speaker.

- Front (L)
- Front (R)
- Center
- Rear (L)
- Rear (R)
- Rear (Monaural): This signal can be either the Dolby Surround Sound processed signals or the Dolby Digital sound's monaural rear audio signals.
- LFE (Low Frequency Effect) signal

## Surround Mode Settings

**DVDVideo** **DVDVR** **VCD** **CD** **DATA CD**

**DATA DVD**

You can enjoy surround sounds while playing discs including Dolby Digital and DTS DVDs, even if you have only 2 or 4 speakers. Select the surround mode that best suits your speaker setup.

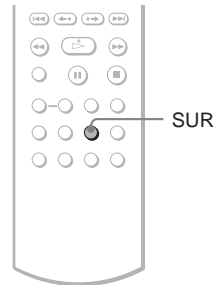

## 1 Press SUR during playback.

The following display appears.

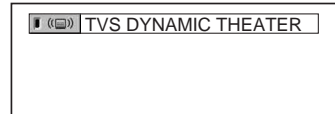

## 2 Press SUR repeatedly to select one of the surround modes.

See the explanations given for each item in the following section.

### ◆ For 2 speaker setups

- TVS DYNAMIC THEATER
- TVS DYNAMIC
- TVS WIDE
- TVS NIGHT
- TVS STANDARD

### ◆ For 4 to 6 speaker setups

(If you select "NONE" in the setting of "REAR" in "SPEAKER SETUP" (page 76), you cannot select these modes.)

- NORMAL SURROUND
- ENHANCED SURROUND
- VIRTUAL REAR SHIFT
- VIRTUAL MULTI REAR
- VIRTUAL MULTI DIMENSION

## To cancel the setting

Select "OFF" in step 2.

## For 2 speaker setups

When you connect a stereo TV or 2 front speakers, TVS (TV Virtual Surround) lets you enjoy surround sound effects by using sound imaging to create virtual rear speakers from the sound of the front speakers (L: left, R: right) without using actual rear speakers. TVS was developed by Sony to produce surround sound for home use using just a stereo TV.

This only works when playing a multichannel Dolby audio sound track. Furthermore, if the player is set up to output the signal from the DIGITAL OUT (OPTICAL or COAXIAL)/HDMI OUT jack, the surround effect will only be heard when "DOLBY DIGITAL" and "DTS" are set to "D-PCM" in "AUDIO SETUP" (page 74).

### ◆TVS DYNAMIC THEATER

Creates one set of LARGE virtual rear speakers and virtual subwoofer from the sound of the front speakers (L, R) without using actual rear speakers and subwoofer (shown below).

This mode is effective when the distance between the front L and R speakers is short, such as with built-in speakers on a stereo TV.

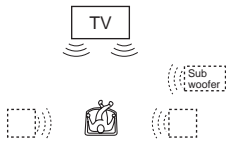

### ◆TVS DYNAMIC

Creates one set of virtual rear speakers from the sound of the front speakers (L, R) without using actual rear speakers (shown below). This mode is effective when the distance between the front L and R speakers is short, such as with built-in speakers on a stereo TV.

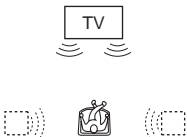

### ◆TVS WIDE

Creates five sets of virtual rear speakers from the sound of the front speakers (L, R) without using actual rear speakers (shown below). This mode is effective when the distance between the front L and R speakers is short, such as with built-in speakers on a stereo TV.

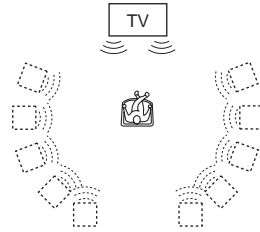

### ◆TVS NIGHT

Large sounds, such as explosions, are suppressed, but the quieter sounds are unaffected. This feature is useful when you want to hear the dialog and enjoy the surround sound effects of "TVS WIDE" at low volume.

### ◆TVS STANDARD

Creates three sets of virtual rear speakers from the sound of the actual front speakers (L, R) as shown below. This mode is effective when you use 2 separate speakers.

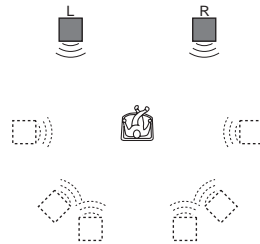

L: Front speaker (left)  
R: Front speaker (right)  
□: Virtual speaker

## For 4 to 6 speaker setups

You can enjoy the following surround effects by using the 2 front speakers and 2 rear speakers.

Connect the player to the amplifier (receiver) with the **B-1** connection (page 22).

You can experience Dolby Surround (Pro Logic) sounds or Digital Cinema Sound (DCS). DCS uses sound imaging to shift the sound of the rear speakers away from the actual speaker position or create entire sets of virtual rear speakers from one set of actual rear speakers. “VIRTUAL REAR SHIFT,” “VIRTUAL MULTI REAR,” and “VIRTUAL MULTI DIMENSION” make use of this technology.

### ◆NORMAL SURROUND

Software with 2 channel audio signals is decoded with the Dolby Surround (Pro Logic) decoder to create surround effects. The rear speakers will emit identical monaural sounds. If you are using a center speaker, the appropriate sounds for the center speaker will be delivered.

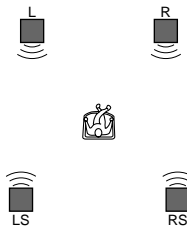

### ◆ENHANCED SURROUND

Provides a greater sense of presence from a Dolby Surround (Pro Logic) source with a monaural rear channel signal. Produces a stereo like effect in the rear channels.

### ◆VIRTUAL REAR SHIFT

Shifts the sound of the rear speakers away from the actual speaker position.

The shift position differs according to “REAR” or “SIDE” setting of the rear speakers (page 75).

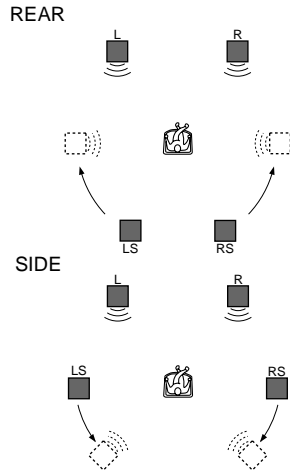

### ◆VIRTUAL MULTI REAR

Creates an array of virtual rear speakers from a single set of actual rear speakers.

The position of the virtual rear speakers differs according to “REAR” or “SIDE” setting of the rear speakers (page 75).

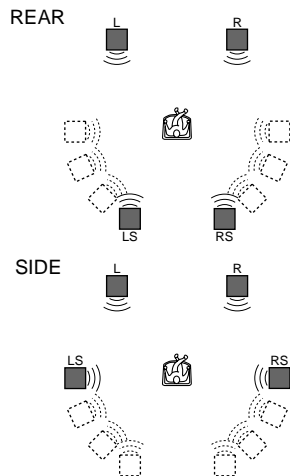

## ◆VIRTUAL MULTI DIMENSION

Creates an array of virtual rear speaker positions higher than the listener from a single set of actual rear speakers.

This mode creates five sets of virtual speakers surrounding the listener at approximately a 30° angle of elevation. The effect differs according to “REAR” or “SIDE” setting of the rear speakers (page 75).

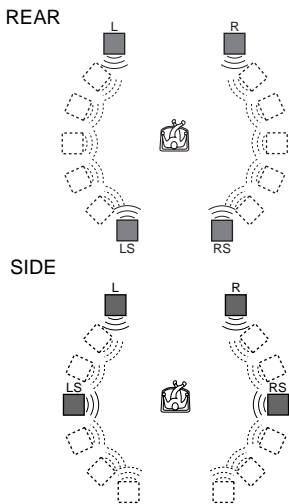

L: Front speaker (left)  
R: Front speaker (right)  
LS: Rear speaker (left)  
RS: Rear speaker (right)  
□: Virtual speaker

## Notes

- When you select one of the surround modes, turn off the surround setting of the connected TV or amplifier (receiver).
- Not all discs will respond to the “TVS NIGHT” function in the same way.
- To enjoy the multichannel audio through the 5.1CH OUTPUT jacks, correctly set each speaker position and distance (page 22, 75).
- When the playing signal does not contain a signal for the rear speakers, you cannot hear the TVS effect.
- When you select one of the TVS modes, the player does not output the sound of center speaker.
- Make sure that your listening position is between and at an equal distance from your speakers, and that the speakers are located in similar surroundings.
- If you use the DIGITAL OUT (OPTICAL or COAXIAL)/HDMI OUT jack and set “DOLBY DIGITAL” to “DOLBY DIGITAL,” and “DTS” to “DTS,” in “AUDIO SETUP”, sound will come from your speakers but it will not have the SURROUND effect.
- The surround effects do not work when using the Fast Play or Slow Play functions, even though you can change the surround modes.

## Changing the Angles

DVDVideo

If various angles (multi-angles) for a scene are recorded on the DVD VIDEO, “00” appears in the front panel display. This means that you can change the viewing angle.

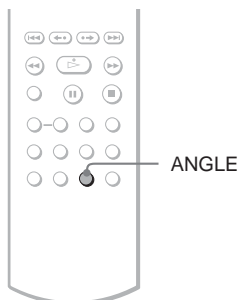

### 1 Press ANGLE during playback.

The number of the angle appears on the display.

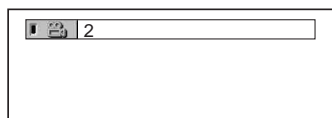

### 2 Press ANGLE repeatedly to select an angle number.

The scene changes to the selected angle.

#### Note

Depending on the DVD VIDEO, you may not be able to change the angles even if multi-angles are recorded on the DVD VIDEO.

## Displaying the Subtitles

DVDVideo DVDVR

If subtitles are recorded on the discs, you can change the subtitles or turn them on and off whenever you want while playing a DVD.

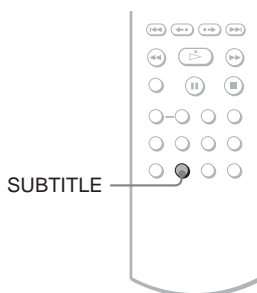

### 1 Press SUBTITLE during playback.

The following display appears.

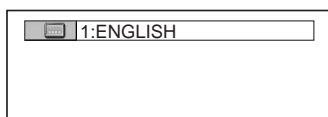

### 2 Press SUBTITLE repeatedly to select a setting.

◆ When playing a DVD VIDEO  
Select the language.

Depending on the DVD VIDEO, the choice of language varies.

When 4 digits are displayed, they indicate a language code. See “Language Code List” on page 85 to see which language the code represents.

◆ When playing a DVD-VR mode disc  
Select “ON.”

#### To turn off the subtitles

Select “OFF” in step 2.

#### Notes

- Depending on the DVD VIDEO, you may not be able to change the subtitles even if multilingual subtitles are recorded on it. You also may not be able to turn them off.
- While playing a disc with subtitles, the subtitle may disappear when you press FAST PLAY or SLOW PLAY button.

## Adjusting the Playback Picture (CUSTOM PICTURE MODE)

DVD<sub>video</sub> DVD<sub>VR</sub> VCD DATA CD

DATA DVD

You can adjust the video signal of the DVD, VIDEO CD or DATA CD/DATA DVD in JPEG format from the player to obtain the picture quality you want. Choose the setting that best suits the program you are watching. When you select “MEMORY,” you can make further adjustments to each element of the picture (color, brightness, etc.).

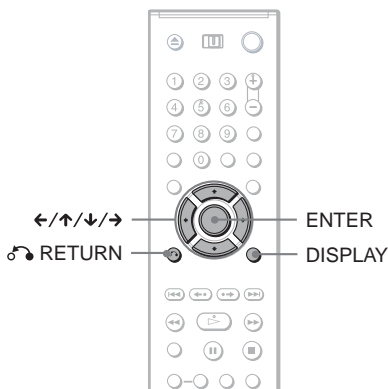

### 1 Press DISPLAY twice during playback.

The Control Menu appears.

### 2 Press $\uparrow/\downarrow$ to select , then press ENTER.

The options for “CUSTOM PICTURE MODE” appear.

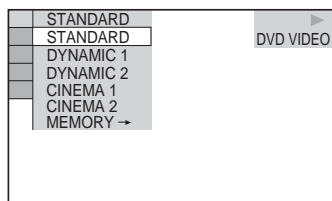

### 3 Press $\uparrow/\downarrow$ to select the setting you want.

The default setting is underlined.

- STANDARD: displays a standard picture.
- DYNAMIC 1: produces a bold dynamic picture by increasing the picture contrast and the color intensity.
- DYNAMIC 2: produces a more dynamic picture than DYNAMIC 1 by further increasing the picture contrast and color intensity.
- CINEMA 1: enhances details in dark areas by increasing the black level.
- CINEMA 2: white colors become brighter and black colors become richer and the color contrast is increased.
- MEMORY: adjusts the picture in greater detail.

### 4 Press ENTER.

The selected setting takes effect.

#### Hint

When you watch a movie, “CINEMA 1” or “CINEMA 2” is recommended.

## Adjusting the picture items in “MEMORY”

You can adjust each element of the picture individually.

- PICTURE: changes the contrast
- BRIGHTNESS: changes the overall brightness
- COLOR: makes the colors deeper or lighter
- HUE: changes the color balance

### 1 In step 3 of “Adjusting the Playback Picture,” select “MEMORY” and press ENTER.

The “PICTURE” adjustment bar appears.



- 2** Press  $\leftarrow/\rightarrow$  to adjust the picture contrast.

To go the next or previous picture item without saving the current setting, press  $\uparrow/\downarrow$ .

- 3** Press ENTER.

The adjustment is saved and "BRIGHTNESS" adjustment bar appears.

- 4** Repeat step 2 and 3 to adjust "BRIGHTNESS," "COLOR" and "HUE."

#### To turn off the display

Press  $\leftarrow$  RETURN or DISPLAY.

#### Note

The "BRIGHTNESS" setting is not effective if you connect the player via the LINE OUT (VIDEO) or S VIDEO OUT jack and select "PROGRESSIVE AUTO" or "PROGRESSIVE VIDEO" by using the PROGRESSIVE button on the front panel.

## Sharpening the Pictures

(SHARPNESS) DVDVideo DVDVR VCD

DATA CD DATA DVD

You can enhance the outlines of images to produce a sharper picture.

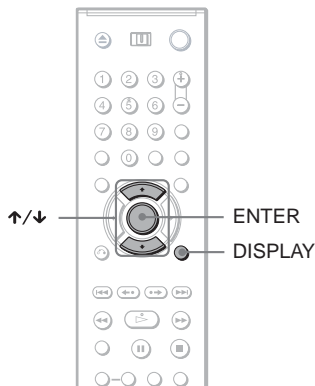

- 1** Press DISPLAY twice during playback.

The Control Menu appears.

- 2** Press  $\uparrow/\downarrow$  to select  (SHARPNESS), then press ENTER.

The options for "SHARPNESS" appear.

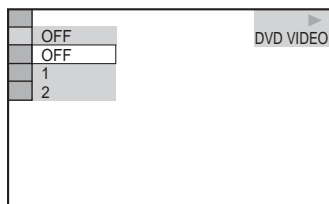

- 3** Press  $\uparrow/\downarrow$  to select a level.

- 1: enhances the outline.
- 2: enhances the outline more than 1.

- 4** Press ENTER.

The selected setting takes effect.

## To cancel the "SHARPNESS" setting

Select "OFF" in step 3.

### Note

This setting is not effective if you connect the player via the LINE OUT (VIDEO) or S VIDEO OUT jack and select "PROGRESSIVE AUTO" or "PROGRESSIVE VIDEO" by using the PROGRESSIVE button on the front panel.

## Adjusting the Picture Quality (BNR, MNR) **DVDVideo**

**DVDvr** **VCD** **DATA CD** **DATA DVD**

You can adjust the picture quality by "BNR" (Block Noise Reduction) or "MNR" (Mosquito Noise Reduction)

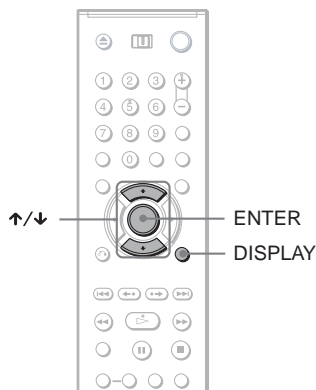

## Adjusting the BNR

The "BNR" function adjusts the picture quality by reducing the "block noise" or mosaic like patterns that appear on your TV screen.

- 1 Press **DISPLAY** twice during playback.

The Control Menu appears.

- 2 Press **↑/↓** to select **BNR** (BNR), then press **ENTER**.

The options for "BNR" appear.

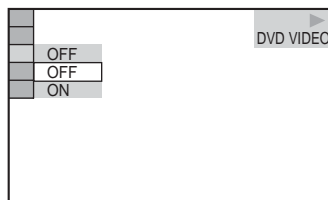

### 3 Press $\uparrow/\downarrow$ to select the setting.

- OFF: To cancel the “BNR” effect.
- ON: To turn on the “BNR” effect.

### 4 Press ENTER.

The disc plays with the setting you selected.

#### To cancel the “BNR” setting

Select “OFF” in step 3.

#### To turn off the Control Menu

Press DISPLAY repeatedly until the Control Menu is turned off.

#### Notes

- If the outlines of the images on your screen should become blurred, set “BNR” to “OFF.”
- Depending on the disc or the scene being played, there may be no “BNR” effect, or it may be hard to discern.

## Adjusting the MNR

The “MNR” function adjusts the picture quality by reducing the faint noise appearing around the outlines of the images.

The noise reduction effects are automatically adjusted within each setting range according to the video bit rate and other factors.

### 1 Press DISPLAY twice during playback.

The Control Menu appears.

### 2 Press $\uparrow/\downarrow$ to select (MNR), then press ENTER.

The options for “MNR” appear.

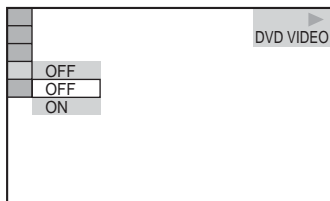

### 3 Press $\uparrow/\downarrow$ to select the setting.

- OFF: To cancel the “MNR” effect.
- ON: To turn on the “MNR” effect.

### 4 Press ENTER.

The disc plays with the setting you selected.

#### To cancel the “MNR” setting

Select “OFF” in step 3.

#### To turn off the Control Menu

Press DISPLAY repeatedly until the Control Menu is turned off.

#### Notes

- If the outlines of the images on your screen should become blurred, set “MNR” to “OFF.”
- Depending on the disc or the scene being played, there may be no “MNR” effect, or it may be hard to discern.

# Adjusting the Delay Between the Picture and Sound (AV SYNC)

DVDVideo DVDVR VCD

When the sound does not match the pictures on the screen, you can adjust the delay between the picture and sound.

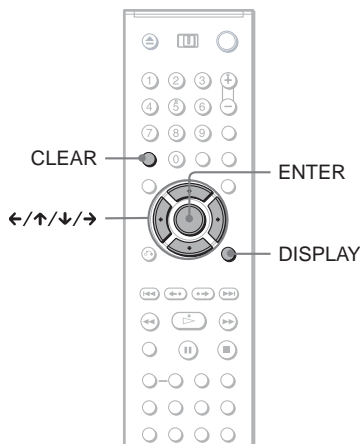

## 1 Press DISPLAY twice during playback.

The Control Menu appears.

## 2 Press ↑/↓ to select (AV SYNC), then press ENTER.

The following display appears.

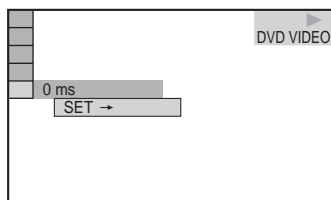

## 3 Press ↓ to select "SET →", then press ENTER.

The "AV SYNC" adjustment bar appears.



## 4 Press → repeatedly to adjust the delay.

Each time you press ←/→, the delay is adjusted by 10 milliseconds.

## 5 Press ENTER.

The selected setting takes effect.

### To reset the "AV SYNC" setting

Press CLEAR in step 4.

### Notes

- This function is not effective if you use the DIGITAL OUT (OPTICAL or COAXIAL) jack, and set "DOLBY DIGITAL" or "DTS" in AUDIO SETUP to "DOLBY DIGITAL" or "DTS" respectively (page 74).
- This function is not effective if you connect a Dolby Digital or DTS-compliant device via the HDMI OUT jack, and set "DOLBY DIGITAL" or "DTS" in AUDIO SETUP to "DOLBY DIGITAL" or "DTS" respectively (page 74).

## About MP3 Audio Tracks and JPEG Image Files

MP3 is audio compression technology that satisfies the ISO/IEC MPEG regulations. JPEG is image compression technology. You can play DATA CDs/DATA DVDs that contain MP3 audio tracks or JPEG image files.

### DATA CDs/DATA DVDs that the player can play

You can play back DATA CDs (CD-ROMs/CD-Rs/CD-RWs) or DATA DVDs (DVD-ROMs/DVD+RWs/DVD+Rs/DVD-RWs/DVD-Rs) recorded in MP3 (MPEG-1 Audio Layer III) and JPEG format.

However, this player only plays DATA CDs whose logical format is ISO 9660 Level 1/Level 2 or Joliet and DATA DVDs of Universal Disk Format (UDF).

Refer to the instructions supplied with the disc drives and the recording software (not supplied) for details on the recording format.

#### Note

The player may not be able to play some DATA CDs/DATA DVDs created in the Packet Write format.

### MP3 audio track or JPEG image file that the player can play

The player can play the following tracks and files:

- MP3 audio tracks with the extension “.MP3.”
- JPEG image files with the extension “.JPEG” or “.JPG.”
- JPEG image files that conform to the DCF\* image file format.

\* “Design rule for Camera File system”: Image standards for digital cameras regulated by JEITA (Japan Electronics and Information Technology Industries Association).

#### Notes

- The player will play any data with the extension “.MP3,” “.JPG,” or “.JPEG,” even if they are not in MP3 or JPEG format. Playing these data may generate a loud noise which could damage your speaker system.
- The player does not conform to audio tracks in mp3PRO format.
- Some JPEG files cannot be played.

### About playback order of albums, tracks and files

Albums play in the following order:

#### ◆ Structure of disc contents

Tree 1 Tree 2 Tree 3 Tree 4 Tree 5

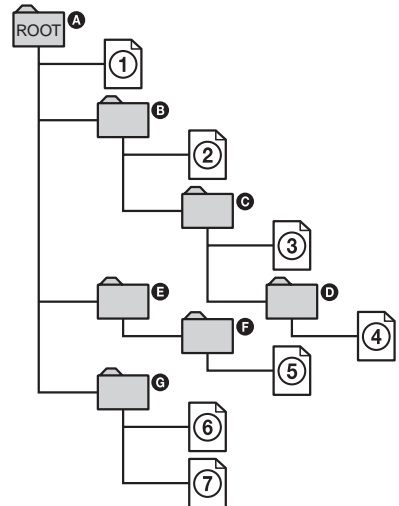

When you insert a DATA CD/DATA DVD and press  $\triangleright$ , the numbered tracks (or files) are played sequentially, from ① through ⑦. Any sub-albums/tracks (or files) contained within a currently selected album take priority over the next album in the same tree. (Example: ② contains ④ so ④ is played before ⑤.)

When you press MENU and the list of album names appears (page 58), the album names are arranged in the following order: ① → ② → ③ → ④ → ⑤ → ⑥ → ⑦. Albums that do not contain tracks (or files) (such as album ⑤) do not appear in the list.

### Hints

- If you add numbers (01, 02, 03, etc.) to the front of the track/file names when you store the tracks (or files) in a disc, the tracks and files will be played in that order.
- Since a disc with many trees takes longer to start playback, it is recommended that you create albums with no more than two trees.

### Notes

- Depending on the software you use to create the DATA CD/DATA DVD, the playback order may differ from the above illustration.
- The playback order above may not be applicable if there are more than 200 albums and 300 tracks/files in each album.
- The player can recognize up to 200 albums (the player will count just albums, including albums that do not contain MP3 audio tracks and JPEG image files). The player will not play any albums beyond the 200th album.
- Proceeding to the next or another album may take some time.

## Playing MP3 Audio Tracks or JPEG Image Files **DATA CD** **DATA DVD**

You can play MP3 audio tracks and JPEG image files on DATA CDs (CD-ROMs/CD-Rs/CD-RWs) or DATA DVDs (DVD-ROMs/DVD+RWs/DVD+Rs/DVD-RWs/DVD-Rs).

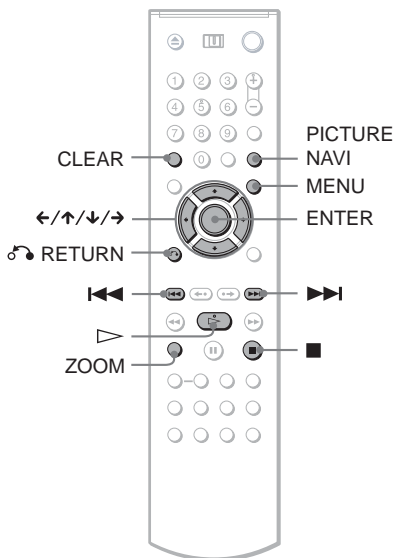

### Hint

You can view the disc information while playing MP3 audio tracks (page 42).

### Notes

- DATA CDs recorded in KODAK Picture CD format automatically start playing when inserted.
- If no MP3 audio track or JPEG image file is recorded on the DATA CD/DATA DVD, “No audio data” or “No image data” appears on the screen.

---

## Selecting an album

### 1 Press MENU.

The list of albums on the disc appears. When an album is being played, its title is shaded.

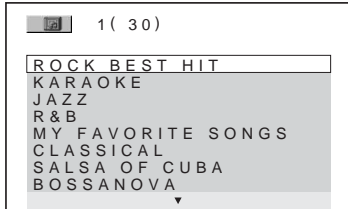

### 2 Press $\uparrow/\downarrow$ to select the album you want to play.

### 3 Press $\triangleright$ .

Playback starts from the selected album.

To select MP3 audio tracks, see “Selecting an MP3 audio track” (page 58).

To select JPEG image files, see “Selecting a JPEG image file” (page 59).

---

#### To stop playback

Press  $\blacksquare$ .

#### To go to the next or previous page

Press  $\rightarrow$  or  $\leftarrow$ .

#### To turn on or off the display

Press MENU repeatedly.

#### Hint

Of the selected album, you can select to play only the MP3 audio tracks, JPEG image files or both, by setting “MODE (MP3, JPEG)” (page 60).

---

## Selecting an MP3 audio track

### 1 After step 2 of “Selecting an album,” press ENTER.

The list of tracks in the album appears.

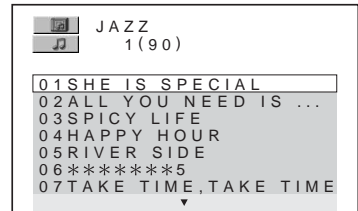

### 2 Press $\uparrow/\downarrow$ to select a track and press ENTER.

Playback starts from the selected track.

---

#### To stop playback

Press  $\blacksquare$ .

#### To go to the next or previous page

Press  $\rightarrow$  or  $\leftarrow$ .

#### To return to the previous display

Press  $\leftarrow$  RETURN.

#### To go to the next or previous MP3 audio track

Press  $\blacktriangleright\blacktriangleright$  or  $\blacktriangleleft\blacktriangleleft$  during playback. You can select the first track of the next album by pressing  $\blacktriangleright\blacktriangleright$  during playback of the last track of the current album.

Note that you cannot return to the previous album by using  $\blacktriangleleft\blacktriangleleft$  and that you need to select the previous album from the album list.

## Selecting a JPEG image file

### 1 After step 2 of "Selecting an album," press PICTURE NAVI.

The image files in the album appear in 16 subscreens. A scroll box is displayed on the right.

1	2	3	4
5	6	7	8
9	10	11	12
13	14	15	16

To display the additional image, select the bottom images and press  $\downarrow$ . To return to the previous image, select the top images and press  $\uparrow$ .

### 2 Press $\leftarrow/\uparrow/\downarrow/\rightarrow$ to select the image you want to view, and press ENTER.

The selected image appears.  
Example

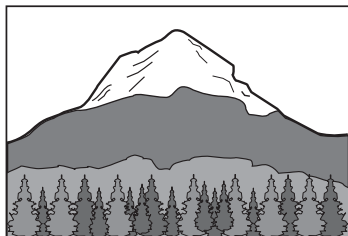

### To go to the next or previous JPEG image file

Press  $\leftarrow$  or  $\rightarrow$  during playback. You can select the first file of the next album by pressing  $\rightarrow$  during playback of the last file of the current album.

Note that you cannot return to the previous album by using  $\leftarrow$  and that you need to select the previous album from the album list.

### To rotate a JPEG image

Press  $\uparrow/\downarrow$  while viewing the image. Each time you press  $\uparrow$ , the image rotates counterclockwise by 90 degrees.

To return to normal view, press CLEAR.

Note that the view also returns to normal if you press  $\leftarrow/\rightarrow$  to go to the next or previous image.

Example: when  $\uparrow$  is pressed once.

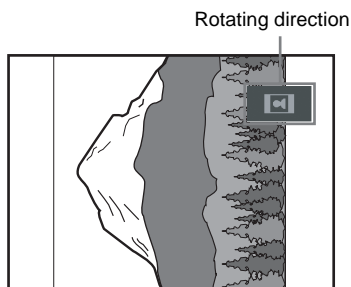

### To magnify a JPEG image (ZOOM)

Press ZOOM while viewing the image. You can enlarge the image up to four times the original size and scroll using  $\leftarrow/\uparrow/\downarrow/\rightarrow$ .

To return to normal view, press CLEAR.

#### ◆When pressed once (x2)

The image enlarges twice the original size.

#### ◆When pressed twice (x4)

The image enlarges four times the original size.

### To stop viewing the JPEG image

Press  $\blacksquare$ .

#### 💡 Hints

- While viewing JPEG image files, you can set options such as "INTERVAL" (page 61), "EFFECT" (page 61) and "SHARPNESS" (page 52).
- You can view JPEG images files without MP3 audio by setting "MODE (MP3, JPEG)" to "IMAGE (JPEG)" (page 60).
- The date the picture was taken is displayed beside "DATE" in the Control Menu (page 14). Note that no date may appear depending on the digital camera.

#### Note

PICTURE NAVI does not work if "AUDIO (MP3)" is selected in "MODE (MP3, JPEG)" (page 60).

# Enjoying JPEG Images as a Slide Show

**DATA CD DATA DVD**

You can play JPEG image files on a DATA CD or DATA DVD successively as a slide show.

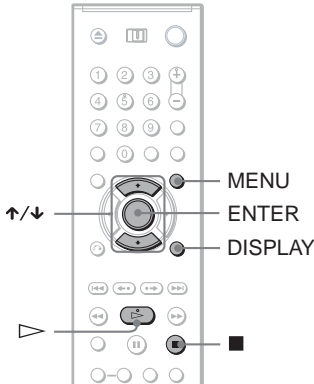

## 1 Press MENU.

The list of albums on the DATA CD/ DATA DVD appears.

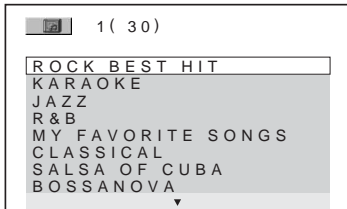

## 2 Press $\uparrow/\downarrow$ to select an album.

## 3 Press $\blacktriangleright$ .

The JPEG images in the selected album start playing as a slide show.

### To stop playback

Press  $\blacksquare$ .

### Notes

- The slide show stops when  $\uparrow/\downarrow$  or ZOOM is pressed. To resume the slide show, press  $\blacktriangleright$ .
- This function does not work if "MODE (MP3, JPEG)" is set to "AUDIO (MP3)" (page 60).

# Viewing a slide show with sound (MODE (MP3, JPEG))

When JPEG image files and MP3 audio tracks are placed in the same album, you can enjoy a slide show with sound.

## 1 Press DISPLAY during stop mode.

The Control Menu appears.

## 2 Press $\uparrow/\downarrow$ to select $\text{CD/DVD}$ (MODE (MP3, JPEG)) and press ENTER.

The options for "MODE (MP3, JPEG)" appear.

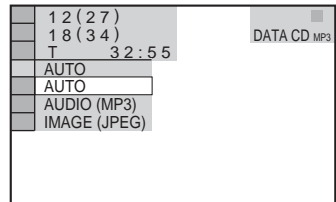

## 3 Press $\uparrow/\downarrow$ to select "AUTO" (default), and press ENTER.

- AUTO: plays both the JPEG image files and MP3 audio tracks in the same album as a slide show.
- AUDIO (MP3): plays only MP3 audio tracks continuously.
- IMAGE (JPEG): plays only JPEG image files continuously.

## 4 Press MENU.

The list of albums on the DATA CD/ DATA DVD appears.

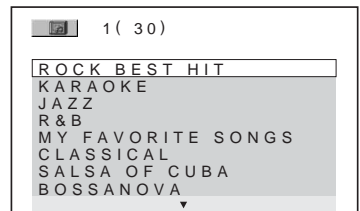

## 5 Press $\uparrow/\downarrow$ to select the album that contains both the MP3 audio tracks and JPEG images you want to play.

## 6 Press $\blacktriangleright$ .

A slide show starts with sound.

## Hints

- To repeat both MP3 audio tracks and JPEG image files in a single album, repeat the same MP3 audio track or album when “MODE (MP3, JPEG)” is set to “AUTO.” See “Playing repeatedly (Repeat Play)” (page 36) to repeat the track or album.
- The player recognizes a maximum of 200 albums regardless of the selected mode. Of each album, the player recognizes up to 300 MP3 audio tracks and 300 JPEG image files when “AUTO” is selected, 600 MP3 audio tracks when “AUDIO (MP3)” is selected, 600 JPEG image files when “IMAGE (JPEG)” is selected.

## Notes

- This function does not work if the MP3 audio tracks and JPEG image files are not placed in the same album.
- If playing time of JPEG image or MP3 audio is longer than the other, the longer one continues without sound or image.
- If you play large MP3 track data and JPEG image data at the same time, the sound may skip. It is recommended that you set the MP3 bit rate to 128 kbps or lower when creating the file. If the sound still skips, then reduce the size of the JPEG file.

## Setting the pace for a slide show (INTERVAL)

You can set the time the slides are displayed on the screen.

- 1 Press **DISPLAY** twice while viewing a JPEG image or when the player is in stop mode.

The Control Menu appears.

- 2 Press **↑/↓** to select  (INTERVAL), then press **ENTER**.

The options for “INTERVAL” appear.

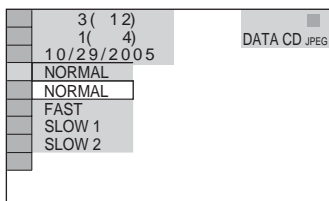

- 3 Press **↑/↓** to select a setting.

The default setting is underlined.

- **NORMAL**: sets the duration to between 6 to 9 seconds.
- **FAST**: sets a duration shorter than NORMAL.

- **SLOW 1**: sets a duration longer than NORMAL.
- **SLOW 2**: sets a duration longer than SLOW 1.

- 4 Press **ENTER**.

## Note

Some JPEG files, especially progressive JPEG files or JPEG files of 3,000,000 pixels or more, may take longer to display than others, which may make the duration seem longer than the setting you selected.

## Selecting the slides' appearance (EFFECT)

You can select the way the slides are displayed during a slide show.

- 1 Press **DISPLAY** twice while viewing a JPEG image or when the player is in stop mode.

- 2 Press **↑/↓** to select  (EFFECT), then press **ENTER**.

The options for “EFFECT” appear.

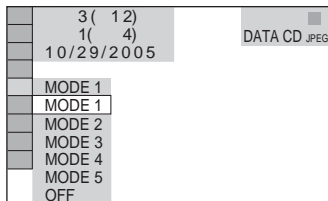

- 3 Press **↑/↓** to select a setting.

The default setting is underlined.

- **MODE 1**: the image sweeps in from top to bottom.
- **MODE 2**: the image sweeps in from left to right.
- **MODE 3**: the image stretches out from the center of the screen.
- **MODE 4**: the images randomly cycle through the effects.
- **MODE 5**: the next image slides over the previous image.
- **OFF**: turns off this function.

- 4 Press **ENTER**.

## Using Various Additional Functions

### Locking Discs (CUSTOM PARENTAL CONTROL, PARENTAL CONTROL)

You can set two kinds of playback restrictions for a disc.

- Custom Parental Control  
You can set playback restrictions so that the player will not play inappropriate discs.
- Parental Control  
Playback of some DVD VIDEOS can be limited according to a predetermined level such as the age of the users. Scenes may be blocked or replaced with different scenes. The same password is used for both Parental Control and Custom Parental Control.

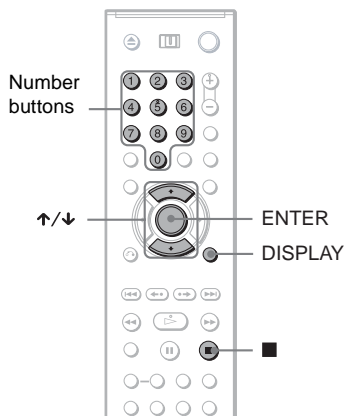

### Custom Parental Control

DVDVideo VCD CD<sup>Super</sup> CD

You can set the same Custom Parental Control password for up to 40 discs. When you set the 41st-disc, the first disc is canceled.

- 1 Insert the disc you want to lock.  
If the disc is playing, press ■ to stop playback.
- 2 Press DISPLAY while the player is in stop mode.  
The Control Menu appears.

- 3 Press ↑/↓ to select  (PARENTAL CONTROL), then press ENTER.

The options for “PARENTAL CONTROL” appear.

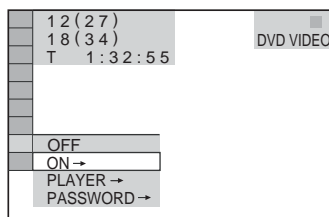

- 4 Press ↑/↓ to select “ON →,” then press ENTER.

◆ If you have not entered a password  
The display for registering a new password appears.

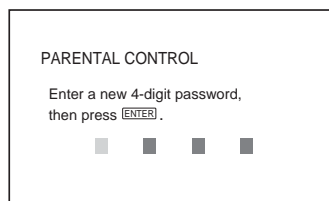

Enter a 4-digit password using the number buttons, then press ENTER.  
The display for confirming the password appears.

◆ When you have already registered a password  
The display for entering the password appears.

- 5 Enter or re-enter your 4-digit password using the number buttons, then press ENTER.

“Custom parental control is set.” appears and then the screen returns to the Control Menu.

## To turn off the Custom Parental Control function

- 1 Follow steps 1 to 3 of “Custom Parental Control.”
- 2 Press  $\uparrow/\downarrow$  to select “OFF  $\rightarrow$ ,” then press ENTER.
- 3 Enter your 4-digit password using the number buttons, then press ENTER.

## To play a disc for which Custom Parental Control is set

- 1 Insert the disc for which Custom Parental Control is set.  
The “CUSTOM PARENTAL CONTROL” display appears.

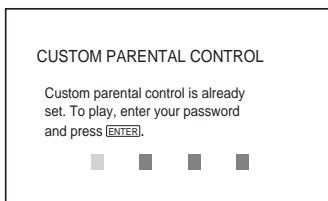

- 2 Enter your 4-digit password using the number buttons, then press ENTER.  
The player is ready for playback.

### **Hint**

If you forget your password, enter the 6-digit number “199703” using the number buttons when the “CUSTOM PARENTAL CONTROL” display asks you for your password, then press ENTER. The display will ask you to enter a new 4-digit password.

## Parental Control (limited playback)

Playback of some DVD VIDEOS can be limited according to a predetermined level such as the age of the users. The “PARENTAL CONTROL” function allows you to set a playback limitation level.

- 1 Press DISPLAY while the player is in stop mode.

The Control Menu appears.

- 2 Press  $\uparrow/\downarrow$  to select  (PARENTAL CONTROL), then press ENTER.

The options for “PARENTAL CONTROL” appear.

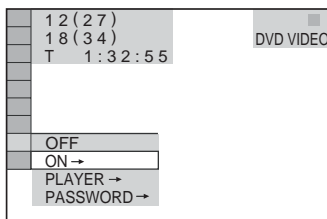

- 3 Press  $\uparrow/\downarrow$  to select “PLAYER  $\rightarrow$ ,” then press ENTER.

### ◆ If you have not entered a password

The display for registering a new password appears.

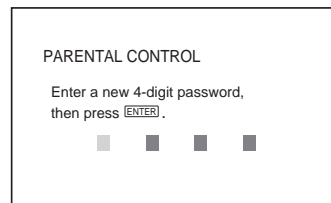

Enter a 4-digit password using the number buttons, then press ENTER. The display for confirming the password appears.

### ◆ When you have already registered a password

The display for entering the password appears.

**4** Enter or re-enter your 4-digit password using the number buttons, then press ENTER.

The display for setting the playback limitation level appears.

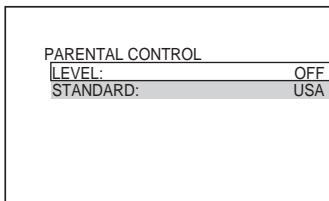

**5** Press  $\uparrow/\downarrow$  to select "STANDARD," then press ENTER.

The selection items for "STANDARD" are displayed.

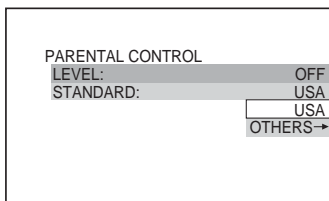

**6** Press  $\uparrow/\downarrow$  to select a geographic area as the playback limitation level, then press ENTER.

The area is selected.

When you select "OTHERS →," select and enter a standard code in the table on page 85 using the number buttons.

**7** Press  $\uparrow/\downarrow$  to select "LEVEL," then press ENTER.

The selection items for "LEVEL" are displayed.

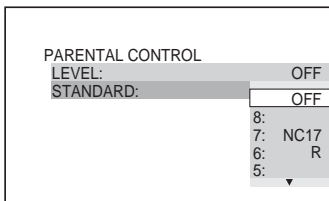

**8** Select the level you want using  $\uparrow/\downarrow$ , then press ENTER.

Parental Control setting is complete.

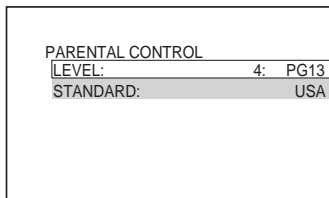

The lower the value, the stricter the limitation.

**To turn off the Parental Control function**

Set "LEVEL" to "OFF" in step 8.

**To play a disc for which Parental Control is set**

- 1 Insert the disc and press  $\triangleright$ .  
The display for entering your password appears.
- 2 Enter your 4-digit password using the number buttons, then press ENTER.  
The player starts playback.

**Hint**

If you forget your password, remove the disc and repeat steps 1 to 3 of "Parental Control (limited playback)." When you are asked to enter your password, enter "199703" using the number buttons, then press ENTER. The display will ask you to enter a new 4-digit password. After you enter a new 4-digit password, replace the disc in the player and press  $\triangleright$ . When the display for entering your password appears, enter your new password.

**Notes**

- When you play discs which do not have the Parental Control function, playback cannot be limited on this player.
- Depending on the disc, you may be asked to change the parental control level while playing the disc. In this case, enter your password, then change the level. If the Resume Play mode is canceled, the level returns to the previous level.

---

## Changing the password

- 1 Press DISPLAY while the player is in stop mode.  
The Control Menu appears.
  - 2 Press  $\uparrow/\downarrow$  to select  (PARENTAL CONTROL), then press ENTER.  
The options for "PARENTAL CONTROL" appear.
  - 3 Press  $\uparrow/\downarrow$  to select "PASSWORD  $\rightarrow$ ," then press ENTER.  
The display for entering the password appears.
  - 4 Enter your 4-digit password using the number buttons, then press ENTER.
  - 5 Enter a new 4-digit password using the number buttons, then press ENTER.
  - 6 To confirm your password, re-enter it using the number buttons, then press ENTER.
- 

### If you make a mistake entering your password

Press  $\leftarrow$  before you press ENTER and input the correct number.

---

## Controlling Your TV or AV Amplifier (Receiver) With the Supplied Remote

By adjusting the remote signal, you can control your TV with the supplied remote. If you connect the player to an AV amplifier (receiver), you can control the volume with the supplied remote.

### Notes

- Depending on the connected unit, you may not be able to correctly control your TV or AV amplifier (receiver) using some of the buttons below.
- If you enter a new code number, the code number previously entered will be erased.
- When you replace the batteries of the remote, the code number you have set may be reset to the default setting. Set the appropriate code number again.

---

## Controlling TVs with the remote

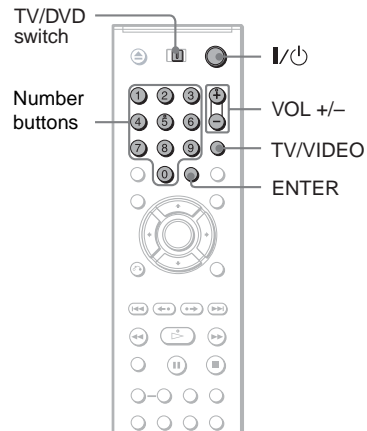

- 1 Slide the TV/DVD switch to TV.
- 2 While holding down I/O, press the number buttons to select the manufacturer's code for your TV (see the table below).
- 3 Release I/O.

When the TV/DVD switch is set to TV, the remote performs the following:

	Turns the TV on or off
VOL +/-	Adjusts the volume of the TV
TV/VIDEO	Switches the TV's input source between the TV and other input sources
Number buttons and ENTER	Selects the channel of the TV

### Code numbers of controllable TVs

If more than one code number is listed, try entering them one at a time until you find the one that works with your TV.

Manufacturer	Code number
Sony	01 (default)
Akai	04
AOC	04
Centurion	12
Coronado	03
Curtis-Mathes	12, 14
Daewoo	04, 22
Daytron	03, 12
Fisher	11
General Electric	04, 06, 10
Gold Star/LG	03, 04, 17
Hitachi	02, 03, 04
J.C.Penney	04, 10, 12
JVC	09
KMC	03
Magnavox	03, 04, 08, 12, 21
Marantz	04, 13
MGA/Mitsubishi	04, 12, 13, 17
NEC	04, 12
Panasonic	06, 19
Philco	02, 03, 04, 08
Philips	08, 21
Pioneer	06, 16
Portland	03

Manufacturer	Code number
Proscan	10
Quasar	06, 18
Radio Shack	05, 10, 14
RCA	04, 10
Sampo	12
Samsung	03, 04, 12, 20
Sanyo	11, 14
Scott	12
Sears	07, 10, 11
Sharp	03, 05, 18
Sylvania	08, 12
Teknika	03, 08, 14
Toshiba	07, 18
Wards	03, 04, 12
Yorx	12
Zenith	14, 15



## Settings and Adjustments

### Using the Setup Display

By using the Setup Display, you can make various adjustments to items such as picture and sound. You can also set a language for the subtitles and the Setup Display, among other things.

For details on each Setup Display item, see pages from 69 to 77.

#### Note

Playback settings stored in the disc take priority over the Setup Display settings and not all of the functions described may work.

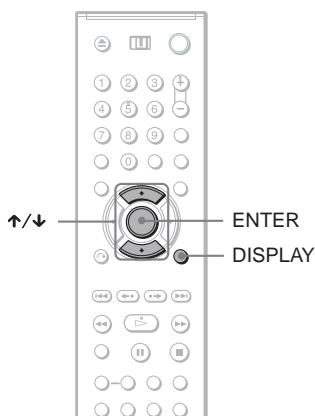

- 1 Press **DISPLAY** when the player is in stop mode.

The Control Menu appears.

- 2 Press **↑/↓** to select  (**SETUP**), then press **ENTER**.

The options for “SETUP” appear.

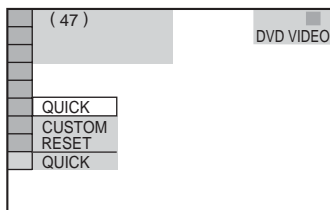

- 3 Press **↑/↓** to select “CUSTOM,” then press **ENTER**.

The Setup Display appears.

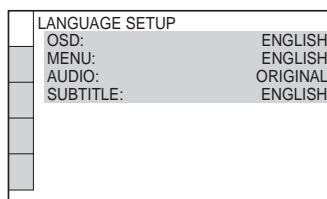

- 4 Press **↑/↓** to select the setup item from the displayed list: “LANGUAGE SETUP,” “SCREEN SETUP,” “CUSTOM SETUP,” “AUDIO SETUP” or “SPEAKER SETUP.” Then press **ENTER**.

The Setup item is selected.

Example: “SCREEN SETUP”

Selected item

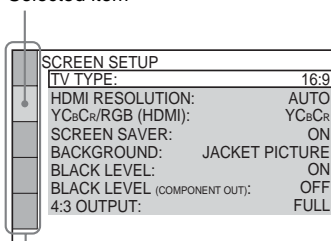

Setup items

- 5 Press **↑/↓** to select an item, then press **ENTER**.

The options for the selected item appear.

Example: “TV TYPE”

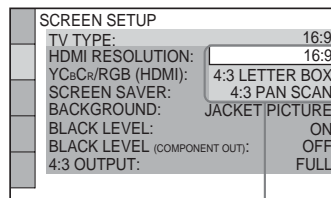

Options

## 6 Press $\uparrow/\downarrow$ to select a setting, then press ENTER.

The setting is selected and setup is complete.

Example: "4:3 PAN SCAN"

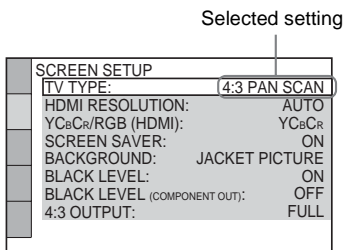

### To enter the Quick Setup mode

Select "QUICK" in step 3. Follow from step 5 of the Quick Setup explanation to make basic adjustments (page 25).

### To reset all of the "SETUP" settings

1 Select "RESET" in step 3 and press ENTER.

2 Select "YES" using  $\uparrow/\downarrow$ .

You can also quit the process and return to the Control Menu by selecting "NO" here.

3 Press ENTER.

All the settings explained on pages 69 to 75 return to the default settings. Do not press  $\mathbb{I}/\mathbb{C}$  while resetting the player, which takes a few seconds to complete.

## Setting the Display or Sound Track Language

### (LANGUAGE SETUP)

"LANGUAGE SETUP" allows you to set various languages for the on-screen display or sound track.

Select "LANGUAGE SETUP" in the Setup Display. To use the display, see "Using the Setup Display" (page 68).

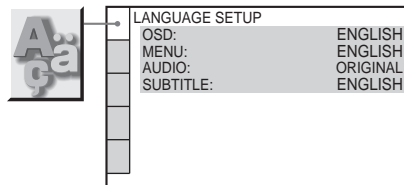

#### ◆ OSD (On-Screen Display)

Switches the display language on the screen.

#### ◆ MENU (DVD VIDEO only)

You can select the desired language for the disc's menu.

#### ◆ AUDIO (DVD VIDEO only)

Switches the language of the sound track. When you select "ORIGINAL," the language given priority in the disc is selected.

#### ◆ SUBTITLE (DVD VIDEO only)

Switches the language of the subtitle recorded on the DVD VIDEO.

When you select "AUDIO FOLLOW," the language for the subtitles changes according to the language you selected for the sound track.

#### 🔔 Hint

If you select "OTHERS  $\rightarrow$ " in "MENU," "SUBTITLE," or "AUDIO," select and enter a language code from "Language Code List" on page 85 using the number buttons.

#### Note

If you select a language in "MENU," "SUBTITLE" or "AUDIO" that is not recorded on a DVD VIDEO, one of the recorded languages will be automatically selected.

# Settings for the Display

## (SCREEN SETUP)

Choose settings according to the TV to be connected.

Select "SCREEN SETUP" in the Setup Display. To use the display, see "Using the Setup Display" (page 68).

The default settings are underlined.

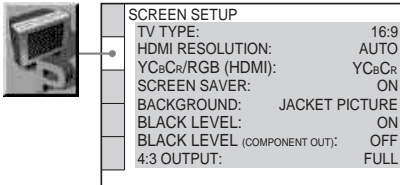

### ◆ TV TYPE

Selects the aspect ratio of the connected TV (4:3 standard or wide).

<u>16:9</u>	Select this when you connect a wide-screen TV or a TV with a wide mode function.
4:3 LETTER BOX	Select this when you connect a 4:3 screen TV. Displays a wide picture with bands on the upper and lower portions of the screen.
4:3 PAN SCAN	Select this when you connect a 4:3 screen TV. Automatically displays the wide picture on the entire screen and cuts off the portions that do not fit.

16:9



4:3 LETTER BOX



4:3 PAN SCAN

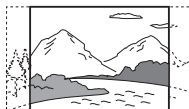

### Note

Depending on the DVD, "4:3 LETTER BOX" may be selected automatically instead of "4:3 PAN SCAN" or vice versa.

### ◆ HDMI RESOLUTION

Selects the type of video signals output from the HDMI OUT jack. When you select AUTO (default), the player outputs video signals of the highest resolution acceptable for your TV. If the picture is not clear, natural or to your satisfaction, try another option that suits the disc and your TV/projector, etc. For details, refer also to the instruction manual supplied with the TV/projector, etc.

<u>AUTO</u>	Normally, select this.
1920×1080i	Sends 1920×1080i video signals.
1280×720p	Sends 1280×720p video signals.
720×480p	Sends 720×480p video signals.

### Note

Even when a setting other than "AUTO" is selected and the connected TV cannot accept the resolution, the player automatically adjusts the video signals that are suitable for the TV.

### ◆ YCbCr/RGB (HDMI)

Selects the type of HDMI signal output from HDMI OUT jack.

<u>YCbCr</u>	Outputs YCbCr signals.
RGB	Outputs RGB signals.

### Notes

- If the playback picture becomes distorted, set "YCbCr" to "RGB."
- If the HDMI OUT jack is connected to equipment with a DVI jack, "RGB" signals will be automatically output even when you select "YCbCr".

#### ◆ SCREEN SAVER

The screen saver image appears when you leave the player in pause or stop mode for 15 minutes, or when you play a Super Audio CD, CD or DATA CD/DATA DVD (MP3 audio) for more than 15 minutes. The screen saver will help prevent your display device from becoming damaged (ghosting). Press  $\triangleright$  to turn off the screen saver.

<u>ON</u>	Turns on the screen saver.
OFF	Turns off the screen saver.

#### ◆ BACKGROUND

Selects the background color or picture on the TV screen when the player is in stop mode or while playing a Super Audio CD, CD or DATA CD/DATA DVD (MP3 audio).

<u>JACKET PICTURE</u>	The jacket picture (still picture) appears, but only when the jacket picture is already recorded on the disc (CD-EXTRA, etc.). If the disc does not contain a jacket picture, the "GRAPHICS" picture appears.
GRAPHICS	A preset picture stored in the player appears.
BLUE	The background color is blue.
BLACK	The background color is black.

#### ◆ BLACK LEVEL

Selects the black level (setup level) for the video signals output from the jacks other than COMPONENT VIDEO OUT/HDMI OUT.

<u>ON</u>	Sets the black level of the output signal to the standard level.
OFF	Lowers the standard black level. Use this when the picture becomes too white.

#### ◆ BLACK LEVEL (COMPONENT OUT)

Selects the black level (setup level) for the video signals output from the COMPONENT VIDEO OUT jacks. You cannot select this when the player outputs progressive signals (page 21).

<u>OFF</u>	Sets the black level of the output signal to the standard level. Normally select this position.
ON	Raises the standard black level. Use this setting when the picture appears too dark.

#### ◆ 4:3 OUTPUT

This setting is effective only when you set "TV TYPE" in "SCREEN SETUP" to "16:9."

Adjust this to watch 4:3 aspect ratio progressive signals. If you can change the aspect ratio on your progressive format (480p) compatible TV, change the setting on your TV, not the player. Note that this setting is effective only for HDMI connection or progressive signals output from the COMPONENT VIDEO OUT jacks.

<u>FULL</u>	Select this when you can change the aspect ratio on your TV.
NORMAL	Select this when you cannot change the aspect ratio on your TV. Shows a 16:9 aspect ratio signal with black bands on left and right sides of the image.

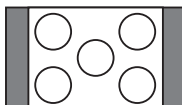

16:9 aspect ratio TV

# Custom Settings (CUSTOM SETUP)

Use this to set up playback related and other settings.

Select "CUSTOM SETUP" in the Setup Display. To use the display, see "Using the Setup Display" (page 68).

The default settings are underlined.

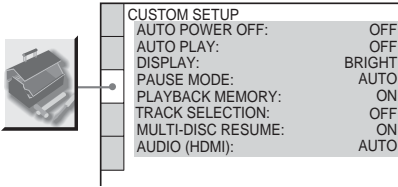

## ◆ AUTO POWER OFF

Switches the Auto Power Off setting on or off.

<u>OFF</u>	Switches this function off.
ON	The player enters standby mode when left in stop mode for more than 30 minutes.

## ◆ AUTO PLAY

Switches the Auto Play setting on or off. This function is useful when the player is connected to a timer (not supplied).

<u>OFF</u>	Switches this function off.
ON	Automatically starts playback when the player is turned on by a timer (not supplied).

## ◆ DISPLAY

Adjusts the lighting of the front panel display.

<u>BRIGHT</u>	Makes the lighting bright.
DARK	Makes the lighting dark.
AUTO DARK	Makes the lighting dark if you do not operate the player or remote for a short while.
AUTO OFF	Turns off the lighting if you do not operate the player or remote for a while.
OFF (FL OFF)	Turns off the lighting. The FL OFF indicator on the player lights up.

## ◆ PAUSE MODE (DVD VIDEO/DVD-VR mode only)

Selects the picture in pause mode.

<u>AUTO</u>	The picture, including subjects that move dynamically, is output with no jitter. Normally select this position.
FRAME	The picture, including subjects that do not move dynamically, is output in high resolution.

## ◆ PLAYBACK MEMORY

The player can store "CUSTOM PICTURE MODE" and other settings of each disc for up to 40 discs (Playback Memory).

Set this function "ON" or "OFF."

<u>ON</u>	Stores the settings in memory when you eject the disc.
OFF	Does not store the settings in memory.

The following settings are stored in memory.

– CUSTOM PICTURE MODE (page 51)\*

– AV SYNC (page 55)\*

– SHARPNESS (page 52)\*

\* DVD VIDEO/VIDEO CD/Super VCD only

## Notes

- The player can store the settings of up to 40 discs. When you store the setting of disc number 41, the first disc setting is cancelled.
- If you run Quick Setup, any settings stored in memory may return to the default settings.

## ◆ TRACK SELECTION (DVD VIDEO only)

Gives the sound track which contains the highest number of channels priority when you play a DVD VIDEO on which multiple audio formats (PCM, DTS, or Dolby Digital format) are recorded.

<u>OFF</u>	No priority given.
AUTO	Priority given.

**Notes**

- When you set the item to “AUTO,” the language may change. The “TRACK SELECTION” setting has higher priority than the “AUDIO” settings in “LANGUAGE SETUP” (page 69).
- If you set “DTS” to “D-PCM” (page 75), the DTS sound track is not played even if you set “TRACK SELECTION” to “AUTO.”
- If PCM, DTS, and Dolby Digital sound tracks have the same number of channels, the player selects PCM, DTS, and Dolby Digital sound tracks in this order.

**◆ MULTI-DISC RESUME (DVD VIDEO/VIDEO CD only)**

Switches the Multi-disc Resume setting on or off. Resume playback can be stored in memory for up to 40 different DVD VIDEOS/VIDEO CDs (page 30).

<u>ON</u>	Stores the resume setting in memory for up to 40 discs.
OFF	Does not store the resume setting in memory. Playback restarts at the resume point only for the current disc in the player.

**Note**

If you run Quick Setup, Multi-disc Resume settings stored in memory may return to the default settings.

**◆ AUDIO (HDMI)**

Selects the type of audio signal output from the HDMI OUT jack.

<u>AUTO</u>	Normally, select this. Outputs audio signals according to the “DIGITAL OUT” settings (page 74).
PCM	Converts Dolby Digital, DTS, or 96 kHz/24 bit PCM signals to 48 kHz/16 bit PCM.

**Note**

A loud noise (or no sound) will be output if you connect the player to a TV that is not compatible with DOLBY DIGITAL/DTS signals and “AUTO” is selected. In this case, select “PCM.”

**Settings for the Sound****(AUDIO SETUP)**

“AUDIO SETUP” allows you to set the sound according to the playback and connection conditions.

Select “AUDIO SETUP” in the Setup Display. To use the display, see “Using the Setup Display” (page 68).  
The default settings are underlined.



AUDIO SETUP	
AUDIO ATT:	OFF
AUDIO DRC:	STANDARD
AUDIO FILTER:	SHARP
DOWNMIX:	DOLBY SURROUND
DIGITAL OUT:	ON
DOLBY DIGITAL:	D-PCM
DTS:	D-PCM
48kHz/96kHz PCM:	48kHz/16bit

**◆ AUDIO ATT (attenuation)**

If the playback sound is distorted, set this item to “ON.” The player reduces the audio output level.

This function affects the output of the following jacks:

- LINE OUT L/R (AUDIO) jacks
- 5.1CH OUTPUT jacks

<u>OFF</u>	Normally, select this position.
ON	Select this when the playback sound from the speakers is distorted.

**◆ AUDIO DRC (Dynamic Range Control) (DVD VIDEO/DVD-VR mode only)**

Makes the sound clear when the volume is turned down when playing a DVD that conforms to “AUDIO DRC.”

This function affects the output from the following jacks:

- LINE OUT L/R (AUDIO) jacks
- 5.1CH OUTPUT jacks
- DIGITAL OUT (OPTICAL or COAXIAL)/HDMI OUT jack only when “DOLBY DIGITAL” is set to “D-PCM” (page 74).

<u>STANDARD</u>	Normally select this position.
TV MODE	Makes low sounds clear even if you turn the volume down.
WIDE RANGE	Gives you the feeling of being at a live performance.

### ◆ AUDIO FILTER

Selects the digital filter to reduce noise above 22.05 kHz (Sampling frequency (Fs) of the audio source is 44.1 kHz), 24 kHz (Fs is 48 kHz), or 48 kHz (Fs is above 96 kHz).

<u>SHARP</u>	Provides a wide frequency range and spatial feeling.
SLOW	Provides smooth and warm sound.

### Note

There may be little effect by changing the digital filter depending on the disc or playback environment.

### ◆ DOWNMIX (DVD VIDEO/DVD-VR mode only)

Switches the method for mixing down to 2 channels when you play a DVD which has rear sound elements (channels) or is recorded in Dolby Digital format. For details on the rear signal components, see “Checking the audio signal format” (page 46). This function affects the output of the following jacks:

- LINE OUT L/R (AUDIO) jacks
- DIGITAL OUT (OPTICAL or COAXIAL)/HDMI OUT jack when “DOLBY DIGITAL” and “DTS” is set to “D-PCM” (page 74).

<u>DOLBY SUR-ROUND</u>	Normally, select this position. Multi-channel audio signals are output to 2 channels for enjoying surround sounds.
NORMAL	Multi-channel audio signals are downmixed to 2 channels for use with your stereo.

### ◆ DIGITAL OUT

Selects if audio signals are output via the DIGITAL OUT (OPTICAL or COAXIAL)/HDMI OUT jack.

<u>ON</u>	Normally select this position. When you select “ON,” see “Setting the digital output signal” for further settings.
OFF	The influence of the digital circuit upon the analog circuit is minimal. If you are using the HDMI OUT jack, PCM sound will be output depending on the connected equipment. If the signal is encrypted for copyright protection purposes, the signal is only output as 48 kHz/16 bit PCM.

### Note

Super Audio CD audio signals are not output from a DIGITAL OUT (COAXIAL or OPTICAL)/HDMI OUT jack.

## Setting the digital output signal

Switches the method of outputting audio signals when you connect a component such as an amplifier (receiver) or MD deck with a digital input jack.

For connection details, see page 22. Select “DOLBY DIGITAL,” “DTS,” and “48kHz/96kHz PCM” after setting “DIGITAL OUT” to “ON.”

If you connect a component that is incompatible with the selected audio signal, a loud noise (or no sound) may be heard from the speakers, risking damage to your ears or speakers.

### Notes

- The AV SYNC function (page 55) is not effective if you use the DIGITAL OUT (OPTICAL or COAXIAL) jack, and set “DOLBY DIGITAL” or “DTS” to “DOLBY DIGITAL” or “DTS” respectively.
- The AV SYNC function (page 55) is not effective if you connect a Dolby Digital or DTS-compliant device via the HDMI OUT jack, and set “DOLBY DIGITAL” or “DTS” to “DOLBY DIGITAL” or “DTS” respectively.

### ◆ DOLBY DIGITAL (DVD VIDEO/DVD-VR mode only)

Selects the type of Dolby Digital signal.

<u>D-PCM</u>	Select this when the player is connected to an audio component without a built-in Dolby Digital decoder. You can select whether the signals conform to Dolby Surround (Pro Logic) or not by making adjustments to the “DOWNMIX” item in “AUDIO SETUP” (page 74).
DOLBY DIGITAL	Select this when the player is connected to an audio component with a built-in Dolby Digital decoder.

## Note

If the HDMI OUT jack is connected to equipment not compatible with DOLBY DIGITAL signals, the “D-PCM” signals will be automatically output even when you select “DOLBY DIGITAL.”

## ◆ DTS

Select the type of DTS audio signals.

D-PCM	Select this when the player is connected to an audio component without a built-in DTS decoder.
DTS	Select this when the player is connected to an audio component with a built-in DTS decoder.

## Note

If the HDMI OUT jack is connected to equipment not compatible with DTS signals, the “D-PCM” signals will be automatically output even when you select “DTS.”

## ◆ 48kHz/96kHz PCM (DVD VIDEO only)

Selects the sampling frequency of the audio signal.

48kHz/16bit	The audio signals of DVD VIDEOS are always converted to 48kHz/16bit.
96kHz/24bit	All types of signals including 96kHz/24bit are output in their original format. However, if the signal is encrypted for copyright protection purposes, the signal is only output as 48kHz/16bit.

## Notes

- The analogue audio signals from the LINE OUT L/R (AUDIO) jacks and 5.1CH OUTPUT jacks are not affected by this setting and keep their original sampling frequency level.
- If the HDMI OUT jack is connected to equipment not compatible with 96 kHz/24 bit signals, 48 kHz/16 bit PCM will be automatically output even when you select “96kHz/24bit.”

# Settings for the Speakers (SPEAKER SETUP)

To obtain the best possible surround sound, set the size of the speakers you have connected and their distance from your listening position. Then use the test tone to adjust the volume of the speakers to the same level.

This setting is effective when connecting the speaker with 5.1 CH OUTPUT jacks (page 23).

You can create two different Speaker Setup settings, one for Super Audio CDs and one for all other types of discs.

- 1 Follow steps 1 through 4 of “Using the Setup Display” (page 68) to select “SPEAKER SETUP” in the Setup display.

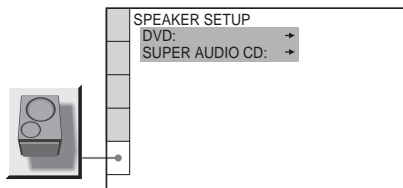

- 2 Select “DVD” or “SUPER AUDIO CD” using  $\uparrow/\downarrow$ , then press ENTER.

Example: “DVD”

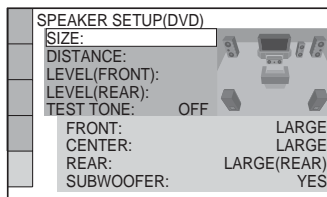

- 3 Set the following items in the order that they are explained below.

The default settings are underlined.

## To return to the default setting

Select the item, then press CLEAR. Note that only the “SIZE” setting does not return to the default setting.

### ◆ SIZE

Selects the size of the speakers.

#### • FRONT

<u>LARGE</u>	Normally select this position.
SMALL	Select this when the speaker cannot reproduce adequate bass frequencies.

#### • CENTER

<u>LARGE</u>	Normally select this position.
SMALL	Select this when the speaker cannot reproduce adequate bass frequencies.
NONE	Select this if you do not connect a center speaker.

#### • REAR

<u>LARGE</u>	(REAR/SIDE): Normally select this position. Select according to the rear speaker position*.
SMALL	(REAR/SIDE): Select this when the sound distorts or the surround effects are difficult to hear. Select according to the rear speaker position*.
NONE	Select this if you do not connect rear speakers.

#### \* Rear speaker position

Correctly specify the location of the rear speakers to enjoy the surround effect.

- Set to “SIDE,” if the location of the rear speakers corresponds to section **A** below.
- Set to “REAR,” if the location of the rear speakers corresponds to section **B** below.

This setting affects only “VIRTUAL REAR SHIFT,” “VIRTUAL MULTI REAR,” and “VIRTUAL MULTI DIMENSION” mode (page 48). This setting does not affect the Super Audio CD Multi audio signals.

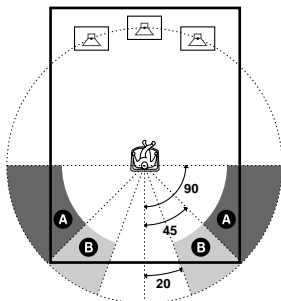

#### • SUBWOOFER

<u>YES</u>	Select this if you connect a subwoofer to output the LFE (Low Frequency Effect) signals from the subwoofer.
NONE	Select this if you do not connect a subwoofer.

### Notes

- The cut off frequency for the subwoofer is fixed at 120 Hz.
- If your speakers are too small to reproduce low bass frequencies, utilize a subwoofer for low frequency sound. When you set the speaker settings to “SMALL,” the bass redirection circuitry will be activated and the bass frequencies for the speakers are output from the subwoofer.
- Even if there are fewer than 6 speakers connected, the player distributes the audio signal components to the front speakers.

### ◆ DISTANCE

Sets the distance from your listening position to the speakers.

Set the distance to your front speakers in “FRONT” first (**A**). Then adjust the values in “CENTER” (center speaker **B**), and “REAR” (rear speaker **C**), and “SUBWOOFER” (**D**) to reflect the actual distance to your center speaker, rear speakers, and subwoofer.

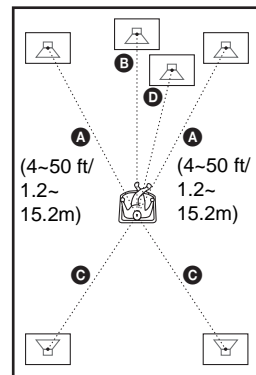

Be sure to change the value in the Setup Display each time you move the speakers. Start from the front speaker. The default adjustments are in parentheses.

FRONT (10 ft/3m)	Set this between 4 and 50 ft (1.2m and 15.2m) in 1 ft (0.3m) increments.
CENTER (10 ft/3m)	Set this within -5 and +2 ft (-1.5m and +0.6m) of the "FRONT" setting in 1 ft (0.3m) increments. For example, if "FRONT" is set to 17 ft (5.1m), "CENTER" can be set between 12 and 19 ft (3.6m and 5.7m).
REAR (10 ft/3m)	Set this within -16 and +2 ft (-4.8m and +0.6m) of the "FRONT" setting in 1 ft (0.3m) increments. For example, if "FRONT" is set to 17 ft (5.1m), "REAR" can be set between 1 and 19 ft (0.3m and 5.7m).
SUBWOOFER (10 ft/3m)	Set this within -5 and +2 ft (-1.5m and 0.6m) of the "FRONT" setting in 1 ft (0.3m) increments. For example, if "FRONT" is set to 17 ft (5.1m), "SUBWOOFER" can be set between 12 and 19 ft (3.6m and 5.7m).

### Note

If each of the front or rear speakers are not placed at an equal distance from your listening position, set the distance according to the closest speaker.

### ◆ LEVEL (FRONT)

Varies the level of the front speakers. Be sure to set "TEST TONE" to "ON" for easy adjustment.

The default adjustments are in parentheses.

L (0 dB)	Set this between -6 dB and 0 dB in 0.5 dB increments.
R (0 dB)	Set this between -6 dB and 0 dB in 0.5 dB increments.
CENTER (0 dB)	Set this between -12 dB and 0 dB in 0.5 dB increments.
SUBWOOFER (DVD: -5 dB/ Super Audio CD: 0 dB)	Set this between -15 dB and +5 dB in 0.5 dB increments.

### ◆ LEVEL (REAR)

Varies the level of the rear speakers. Be sure to set "TEST TONE" to "ON" for easy adjustment.

The default adjustments are in parentheses.

L (0 dB)	Set this between -12 dB and 0 dB in 0.5 dB increments.
R (0 dB)	Set this between -12 dB and 0 dB in 0.5 dB increments.

### To adjust the volume of all the speakers at one time

Use the amplifier's (receiver's) volume control.

### ◆ TEST TONE

The speakers will emit a test tone. Use this when you use the 5.1CH OUTPUT jacks and adjust "LEVEL (FRONT)" and "LEVEL (REAR)."

OFF	The test tone is not emitted from the speakers.
ON	The test tone is emitted from each speaker in sequence while adjusting level.

## Adjusting the speaker volume and level

- 1 Select "SPEAKER SETUP" in the Setup Display.
- 2 Select "TEST TONE" and set to "ON." You will hear the test tone from each speaker in sequence.
- 3 From your listening position, select "LEVEL (FRONT)" or "LEVEL (REAR)" and adjust the value using  $\uparrow/\downarrow$ . The test tone is emitted from both left and right speakers simultaneously.
- 4 Select "TEST TONE" and set to "OFF" to turn off the test tone.

### Note

The test tone signals are not output from the DIGITAL OUT (COAXIAL or OPTICAL)/HDMI OUT jack.

# Troubleshooting

If you experience any of the following difficulties while using the player, use this troubleshooting guide to help remedy the problem before requesting repairs. Should any problem persist, consult your nearest Sony dealer (For cutomers in the USA only).

## Power

**The power is not turned on.**

- ➔ Check that the power cord is connected securely.

## Picture

**There is no picture/picture noise appears.**

- ➔ Re-connect the connecting cord securely.
- ➔ The connecting cords are damaged.
- ➔ Check the connection to your TV (page 18) and switch the input selector on your TV so that the signal from the player appears on the TV screen.
- ➔ The disc is dirty or flawed.
- ➔ If the picture output from your player goes through your VCR to get to your TV or if you are connected to a combination TV/VIDEO player, the copy-protection signal applied to some DVD programs could affect picture quality. If you still experience problems even when you connect your player directly to your TV, try connecting your player to your TV's S VIDEO input (page 18).
- ➔ You have selected "PROGRESSIVE AUTO" or "PROGRESSIVE VIDEO" using the PROGRESSIVE button on the front panel (the PROGRESSIVE indicator lights up) even though your TV cannot accept the progressive signal. In this case, disconnect the HDMI cord from the player and then select "NORMAL (INTERLACE)" so that the PROGRESSIVE indicator turns off.
- ➔ Even if your TV is compatible with progressive format signals, the image may be affected when you set the player to progressive format. In this case, select "NORMAL (INTERLACE)" using the PROGRESSIVE button on the front panel so that the PROGRESSIVE indicator turns

off and the player is set to normal (interlace) format.

- ➔ The VIDEO OFF function takes effect.
- ➔ The player is connected to an input device that is not HDCP compliant (the HDMI indicator on the front panel does not light up). See page 19.
- ➔ If the HDMI OUT jack is used for video output, changing the "HDMI RESOLUTION" setting in "SCREEN SETUP" may solve the problem (page 70). Connect the TV and the player using a video jack other than the HDMI OUT, and switch the TV's input to the connected video input so that you can see the on-screen displays. Change the "HDMI RESOLUTION" setting in "SCREEN SETUP," and switch the TV's input back to HDMI. If the picture still does not appear, repeat the steps and try other options.

**The picture does not fill the screen, even though the aspect ratio is set in "TV TYPE" under "SCREEN SETUP."**

- ➔ The aspect ratio of the disc is fixed on your DVD.

## Sound

**There is no sound.**

- ➔ Re-connect the connecting cord securely.
- ➔ The connecting cord is damaged.
- ➔ The player is connected to the wrong input jack on the amplifier (receiver) (page 22).
- ➔ The amplifier (receiver) input is not correctly set.
- ➔ The player is in pause mode or in Slow-motion Play mode.
- ➔ The player is in fast forward or fast reverse mode.
- ➔ If the audio signal does not come through the DIGITAL OUT (OPTICAL or COAXIAL)/HDMI OUT jack, check the audio settings (page 74).
- ➔ While playing a Super VCD on which the audio track 2 is not recorded, no sound will come out when you select "2:STEREO," "2:1/L," or "2:2/R."
- ➔ Super Audio CD audio signals are not output from the DIGITAL OUT (OPTICAL or COAXIAL)/HDMI OUT jack.
- ➔ The equipment connected to the HDMI OUT jack does not conform to the audio signal format, in this case set "AUDIO (HDMI)" in "CUSTOM SETUP" to "PCM" (page 73).

---

### No sound is output from the HDMI OUT jack

- ➔ The HDMI OUT jack is connected to a DVI device (DVI jacks do not accept audio signals).
- ➔ The HDMI OUT jack does not output Super Audio CD sound.

---

### Sound distortion occurs.

- ➔ Set "AUDIO ATT" in "AUDIO SETUP" to "ON" (page 73).

---

### The sound volume is low.

- ➔ The sound volume is low on some DVDs. The sound volume may improve if you set "AUDIO DRC" in "AUDIO SETUP" to "TV MODE" (page 73).
- ➔ Set "AUDIO ATT" in "AUDIO SETUP" to "OFF" (page 73).

---

### The surround effect is difficult to hear when you are playing a Dolby Digital, or DTS sound track.

- ➔ Check the speaker connections and setting (page 23, 25, 74).
- ➔ The 5.1 channel sound is not recorded on the disc being played.

---

### The sound comes from the center speaker only.

- ➔ Depending on the disc, the sound may come from the center speaker only.
- ➔ Set the surround mode setting to "OFF" (page 46).

---

## Operation

---

### The remote does not function.

- ➔ The batteries in the remote are weak.
- ➔ There are obstacles between the remote and the player.
- ➔ The distance between the remote and the player is too far.
- ➔ The remote is not pointed at the remote sensor on the player.

---

### The disc does not play.

- ➔ The disc is turned over.
- ➔ Insert the disc with the playback side facing down.
- ➔ The disc is skewed.
- ➔ The player cannot play certain discs (page 8).

- ➔ The region code on the DVD does not match the player.
- ➔ Moisture has condensed inside the player (page 5).
- ➔ The player cannot play a recorded disc that is not correctly finalized (page 9).

---

### The MP3 audio track cannot be played (page 57).

- ➔ The DATA CD is not recorded in an MP3 format that conforms to ISO 9660 Level 1/Level 2 or Joliet.
- ➔ The DATA DVD is not recorded in MP3 format that conforms to UDF (Universal Disk Format).
- ➔ The MP3 audio track does not have the extension ".MP3."
- ➔ The data is not formatted in MP3 even though it has the extension ".MP3."
- ➔ The data is not MPEG-1 Audio Layer III data.
- ➔ The player cannot play audio tracks in mp3PRO format.
- ➔ "MODE (MP3, JPEG)" is set to "IMAGE (JPEG)" (page 60).

---

### The JPEG image file cannot be played (page 57).

- ➔ The DATA CD is not recorded in a JPEG format that conforms to ISO 9660 Level 1/Level 2, or Joliet.
- ➔ The DATA DVD is not recorded in JPEG format that conforms to UDF (Universal Disk Format).
- ➔ The file has an extension other than ".JPEG" or ".JPG."
- ➔ The image is larger than 3072 (width) × 2048 (height) in normal mode, or more than 3,300,000 pixels in progressive JPEG. (Some progressive JPEG files cannot be displayed even if the file size is within this specified capacity.)
- ➔ The image does not fit the screen (the image is reduced).
- ➔ "MODE (MP3, JPEG)" is set to "AUDIO (MP3)" (page 60).

---

### The MP3 audio tracks and JPEG image files start playing simultaneously.

- ➔ "MODE (MP3, JPEG)" is set to "AUTO" (page 60).

---

**The album/track/file names are not displayed correctly.**

- ➔ The player can only display numbers and alphabet. Other characters are displayed as “\*”.

---

**The disc does not start playing from the beginning.**

- ➔ Program Play, Shuffle Play, Repeat Play, or A-B Repeat Play is selected (page 34).
- ➔ Resume play has taken effect (page 30).

---

**The player starts playing the disc automatically.**

- ➔ The disc features an auto playback function.
- ➔ “AUTO PLAY” in “CUSTOM SETUP” is set to “ON” (page 72).

---

**Playback stops automatically.**

- ➔ While playing discs with an auto pause signal, the player stops playback at the auto pause signal.

---

**Some functions such as Stop, Search, Fast Play, Slow Play, Slow-motion Play, Repeat Play, Shuffle Play or Program Play cannot be performed.**

- ➔ Depending on the disc, you may not be able to do some of the operations above. Refer to the operating manual that comes with the disc.

---

**The language for the sound track cannot be changed.**

- ➔ Try using the DVD’s menu instead of the direct selection button on the remote (page 31).
- ➔ Multilingual tracks are not recorded on the DVD being played.
- ➔ The DVD prohibits the changing of the language for the sound track.

---

**The subtitle language cannot be changed or turned off.**

- ➔ Try using the DVD’s menu instead of the direct selection button on the remote (page 31).
- ➔ Multilingual subtitles are not recorded on the DVD being played.
- ➔ The DVD prohibits the changing of subtitles.

---

**The angles cannot be changed.**

- ➔ Try using the DVD’s menu instead of the direct selection button on the remote (page 31).
- ➔ Multi-angles are not recorded on the DVD being played.
- ➔ The angle can only be changed when the “” indicator lights up on the front panel display (page 12).
- ➔ The DVD prohibits changing of the angles.

---

**The player does not operate properly.**

- ➔ When static electricity, etc., causes the player to operate abnormally, unplug the player.

---

**Nothing is displayed in the front panel display.**

- ➔ “DISPLAY” in “CUSTOM SETUP” is set to “OFF” or “AUTO OFF.” Set “DISPLAY” to any setting other than “OFF” or “AUTO OFF” (page 72)

---

**5 numbers or letters are displayed on the screen and on the front panel display.**

- ➔ The self-diagnosis function was activated. (See the table on page 81.)

---

**The disc tray does not open and “LOCKED” appears on the front panel display.**

- ➔ Child Lock is set (page 29).

---

**The disc tray does not open and “TRAY LOCKED” appears on the front panel display.**

- ➔ Contact your Sony dealer or local authorized Sony service facility.

---

**“Data error” appears on the TV screen when playing a DATA CD/DATA DVD.**

- ➔ The MP3 audio track/JPEG image file you want to play is broken.
  - ➔ The data is not MPEG-1 Audio Layer III data.
  - ➔ The JPEG image file format does not conform to DCF (page 56).
  - ➔ The JPEG image file has the extension “.JPG” or “.JPEG,” but is not in JPEG format.
-

---

## Self-diagnosis Function

(When letters/numbers appear in the display)

When the self-diagnosis function is activated to prevent the player from malfunctioning, a five-character service number (e.g., C 13 50) with a combination of a letter and four digits appears on the screen and the front panel display. In this case, check the following table.

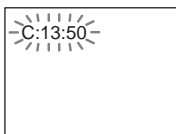

---

First three characters of the service number	Cause and/or corrective action
C 13	The disc is dirty or recorded in a format that this player cannot play (page 8). ➔ Clean the disc with a soft cloth or check its format (page 2).
C 31	The disc is not inserted correctly. ➔ Re-insert the disc correctly.
E XX (xx is a number)	To prevent a malfunction, the player has performed the self-diagnosis function. ➔ Contact your nearest Sony dealer or local authorized Sony service facility and give the 5-character service number. Example: E 61 10

---

---

## Glossary

### Album (page 56, 58)

A unit in which to store JPEG image files or MP3 audio tracks on a DATA CD/DATA DVD. (“Album” is an exclusive definition for this player.)

---

### Chapter (page 14)

Sections of a picture or a music feature that are smaller than titles. A title is composed of several chapters. Depending on the disc, no chapters may be recorded.

---

### Dolby Digital (page 22, 74)

Digital audio compression technology developed by Dolby Laboratories. This technology conforms to multi-channel surround sound. The rear channel is stereo and there is a discrete subwoofer channel in this format. Dolby Digital provides the same discrete channels of high quality digital audio found in “Dolby Digital” theater surround sound systems. Good channel separation is realized because all of the channel data is recorded discretely and little deterioration is realized because all channel data processing is digital.

---

### DTS (page 22, 75)

Digital audio compression technology that Digital Theater Systems, Inc. developed. This technology conforms to multi-channel surround sound. The rear channel is stereo and there is a discrete subwoofer channel in this format. DTS provides the same discrete channels of high quality digital audio. Good channel separation is realized because all of the channel data is recorded discretely and little deterioration is realized because all channel data processing is digital.

---

## DVD VIDEO (page 7)

A disc that contains up to 8 hours of moving pictures even though its diameter is the same as a CD.

The data capacity of a single-layer and single-sided DVD is 4.7 GB (Giga Byte), which is 7 times that of a CD. The data capacity of a double-layer and single-sided DVD is 8.5 GB, a single-layer and double-sided DVD is 9.4 GB, and double-layer and double-sided DVD is 17 GB.

The picture data uses the MPEG 2 format, a worldwide standard of digital compression technology. The picture data is compressed to about 1/40 (average) of its original size. The DVD also uses a variable rate coding technology that changes the data to be allocated according to the status of the picture. Audio information is recorded in a multi-channel format, such as Dolby Digital, allowing you to enjoy a more realistic audio presence.

Furthermore, various advanced functions such as the multi-angle, multilingual, and Parental Control functions are provided with the DVD.

---

## DVD-RW (page 7)

A DVD-RW is a recordable and rewritable disc that is the same size as a DVD VIDEO. The DVD-RW has two different modes: VR mode and Video mode. DVD-RWs created in Video mode have the same format as a DVD VIDEO, while discs created in VR (Video Recording) mode allow the contents to be programmed or edited.

---

## DVD+RW (page 7)

A DVD+RW (plus RW) is a recordable and rewritable disc. DVD+RWs use a recording format that is comparable to the DVD VIDEO format.

---

## File (page 56, 59)

A JPEG image recorded on a DATA CD/DATA DVD ("File" is an exclusive definition for this player.) A single file consist of a single image.

---

## Film based software, Video based software (page 21)

DVDs can be classified as Film based or Video based software. Film based DVDs contain the same images (24 frames per second) that are shown at movie theaters. Video based DVDs, such as television dramas or sit-coms, displays images at 30 frames/60 fields per second.

---

## HDMI (High-Definition Multimedia Interface)

HDMI is an interface that supports both video and audio on a single digital connection. The HDMI connection carries standard to high definition video signals and multi-channel audio signals to AV components such as HDMI equipped TVs, in digital form without degradation.

Since the video signals are compatible with the current DVI (Digital Visual Interface) format, HDMI jacks can be connected to DVI jacks by way of an HDMI-DVI converter cord. The HDMI specification supports HDCP (High-bandwidth Digital Contents Protection), a copy protection technology that incorporates coding technology for digital video signals.

---

## Normal (Interlace) format (page 21)

Normal (Interlace) format shows every other line of an image as a single "field" and is the standard method for displaying images on television. The even number field shows the even numbered lines of an image, and the odd numbered field shows the odd numbered lines of an image.

---

## Progressive format (page 21)

Compared to the Interlace format that alternately shows every other line of an image (field) to create one frame, the Progressive format shows the entire image at once as a single frame. This means that while the Interlace format can show 30 frames/60 fields in one second, the Progressive format can show 60 frames in one second. The overall picture quality increases and still images, text, and horizontal lines appear sharper. This player is compatible with the 480 (525) progressive format.

---

## Progressive JPEG

Progressive JPEGs are used mostly on the internet. They are different from other JPEGs in that they “fade in” gradually instead of being drawn from top to bottom when displayed on a browser. This lets you view the image while it is being downloaded.

---

## Super Audio CD (page 7)

A Super Audio CD disc can reproduce sounds that are extremely faithful to the original sound by use of DSD (Direct Stream Digital) technology. This technology utilizes a sampling frequency of 2.8224 MHz, which is 64 times that of a conventional CD, and 1-bit quantization that enables the disc to hold 4 times the amount of information that a standard PCM format CD can hold. Super Audio CDs are divided into the following types.

- Super Audio CD (single layer disc)  
This disc consists of a single HD layer\*.  
\*High density signal layer for the Super Audio CD

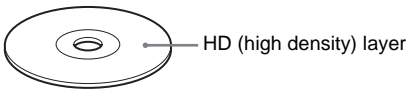

- Super Audio CD (dual layer disc)  
This disc consists of dual HD layers and is capable of extended play over long periods. Also, as the dual layer disc consists of dual HD layers on one side only, you do not have to turn the disc over during playback.

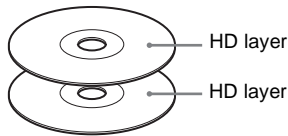

- Super Audio CD + CD (Hybrid disc)  
This disc consists of an HD layer and a CD layer. Also, as the dual layers are on one side only, you do not have to turn the disc over during playback. You can play the CD layer using a conventional CD player.

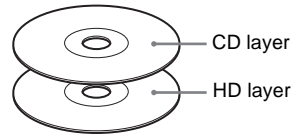

- 2 channel + Multi-channel Super Audio CD  
This disc consists of the 2 channel playback area and the multi-channel playback area.



---

## Title (page 12)

The longest section of a picture or music feature on a DVD, movie, etc., in video software, or the entire album in audio software.

# Specifications

## System

**Laser:** Semiconductor laser

**Signal format system:** NTSC

## Audio characteristics

**Frequency response:** DVD VIDEO (PCM 96 kHz): 2 Hz to 44 kHz ( $\pm 1.0$  dB)/DVD VIDEO (PCM 48 kHz): 2 Hz to 22 kHz ( $\pm 0.5$  dB)/CD: 2 Hz to 20 kHz ( $\pm 0.5$  dB)

**Signal-to-noise ratio (S/N ratio):** 115 dB (LINE OUT L/R (AUDIO) jacks only)

**Harmonic distortion:** 0.003 %

**Dynamic range:** DVD VIDEO: 103 dB/CD: 99 dB

**Wow and flutter:** Less than detected value ( $\pm 0.001\%$  W PEAK)

## Outputs

**(Jack name:** Jack type/Output level/Load impedance)

**LINE OUT (AUDIO):** Phono jack/2 Vrms/10 kilohms

**DIGITAL OUT (OPTICAL):** Optical output jack/ $-18$  dBm (wave length 660 nm)

**DIGITAL OUT (COAXIAL):** Phono jack/0.5 Vp-p/75 ohms

**HDMI OUT:** Type A (19 pin)

**COMPONENT VIDEO OUT(Y, P<sub>B</sub>, P<sub>R</sub>):**

Phono jack/Y: 1.0 Vp-p/P<sub>B</sub>, P<sub>R</sub>:  
interlace\*<sup>1</sup> = 0.648 Vp-p, progressive or  
interlace\*<sup>2</sup> = 0.7 Vp-p/75 ohms

\*<sup>1</sup> BLACK LEVEL (COMPONENT OUT) is ON

\*<sup>2</sup> BLACK LEVEL (COMPONENT OUT) is OFF

**LINE OUT (VIDEO):** Phono jack/1.0 Vp-p/75 ohms

**S VIDEO OUT:** 4-pin mini DIN/Y:

1.0 Vp-p, C: 0.286 Vp-p/75 ohms

**5.1CH OUTPUT:** Phono jack/2 Vrms/10 kilohms

**CONTROL S IN:** Mini jack

## General

**Power requirements:**

120 V AC, 60 Hz

**Power consumption:** 13 W

**Dimensions (approx.):**

430 × 55.5 × 237 mm (width/height/depth) incl. projecting parts

**Mass (approx.):** 2.11 kg

**Operating temperature:** 5 °C to 35 °C

**Operating humidity:** 25 % to 80 %

## Supplied accessories

See page 17.

Specifications and design are subject to change without notice.

ENERGY STAR® is a U.S. registered mark. As an ENERGY STAR® Partner, Sony Corporation has determined that this product meets the ENERGY STAR® guidelines for energy efficiency.

# Language Code List

For details, see pages 45, 50, 69.

The language spellings conform to the ISO 639: 1988 (E/F) standard.

Code Language	Code Language	Code Language	Code Language
1027 Afar	1183 Irish	1347 Maori	1507 Samoan
1028 Abkhazian	1186 Scots Gaelic	1349 Macedonian	1508 Shona
1032 Afrikaans	1194 Galician	1350 Malayalam	1509 Somali
1039 Amharic	1196 Guarani	1352 Mongolian	1511 Albanian
1044 Arabic	1203 Gujarati	1353 Moldavian	1512 Serbian
1045 Assamese	1209 Hausa	1356 Marathi	1513 Siswati
1051 Aymara	1217 Hindi	1357 Malay	1514 Sesotho
1052 Azerbaijani	1226 Croatian	1358 Maltese	1515 Sundanese
1053 Bashkir	1229 Hungarian	1363 Burmese	1516 Swedish
1057 Byelorussian	1233 Armenian	1365 Nauru	1517 Swahili
1059 Bulgarian	1235 Interlingua	1369 Nepali	1521 Tamil
1060 Bihari	1239 Interlingue	1376 Dutch	1525 Telugu
1061 Bislama	1245 Inupiak	1379 Norwegian	1527 Tajik
1066 Bengali;	1248 Indonesian	1393 Occitan	1528 Thai
Bangla	1253 Icelandic	1403 (Afan)Oromo	1529 Tigrinya
1067 Tibetan	1254 Italian	1408 Oriya	1531 Turkmen
1070 Breton	1257 Hebrew	1417 Punjabi	1532 Tagalog
1079 Catalan	1261 Japanese	1428 Polish	1534 Setswana
1093 Corsican	1269 Yiddish	1435 Pashto;	1535 Tonga
1097 Czech	1283 Javanese	Pushto	1538 Turkish
1103 Welsh	1287 Georgian	1436 Portuguese	1539 Tsonga
1105 Danish	1297 Kazakh	1463 Quechua	1540 Tatar
1109 German	1298 Greenlandic	1481 Rhaeto-	1543 Twi
1130 Bhutani	1299 Cambodian	Romance	1557 Ukrainian
1142 Greek	1300 Kannada	1482 Kirundi	1564 Urdu
1144 English	1301 Korean	1483 Romanian	1572 Uzbek
1145 Esperanto	1305 Kashmiri	1489 Russian	1581 Vietnamese
1149 Spanish	1307 Kurdish	1491 Kinyarwanda	1587 Volapük
1150 Estonian	1311 Kirghiz	1495 Sanskrit	1613 Wolof
1151 Basque	1313 Latin	1498 Sindhi	1632 Xhosa
1157 Persian	1326 Lingala	1501 Sangho	1665 Yoruba
1165 Finnish	1327 Laothian	1502 Serbo-	1684 Chinese
1166 Fiji	1332 Lithuanian	Croatian	1697 Zulu
1171 Faroese	1334 Latvian;	1503 Singhalese	
1174 French	Lettish	1505 Slovak	
1181 Frisian	1345 Malagasy	1506 Slovenian	1703 Not specified

Additional Information

# Parental Control Area Code List

For details, see page 63.

Code Area	Code Area	Code Area	Code Area
2044 Argentina	2165 Finland	2362 Mexico	2149 Spain
2047 Australia	2174 France	2376 Netherlands	2499 Sweden
2046 Austria	2109 Germany	2390 New Zealand	2086 Switzerland
2057 Belgium	2248 India	2379 Norway	2528 Thailand
2070 Brazil	2238 Indonesia	2427 Pakistan	2184 United Kingdom
2079 Canada	2254 Italy	2424 Philippines	
2090 Chile	2276 Japan	2436 Portugal	
2092 China	2304 Korea	2489 Russia	
2115 Denmark	2363 Malaysia	2501 Singapore	

# Index

## Numerics

- 16:9 70
- 4:3 LETTER BOX 70
- 4:3 PAN SCAN 70
- 48kHz/96kHz PCM 75
- 5.1 Channel Surround 46

## A

- A-B REPEAT 37
- ADVANCE 29
- ALBUM 40
- Album 56, 81
- ANGLE 50
- AUDIO 45, 69
- AUDIO ATT 73
- AUDIO DRC 73
- AUDIO FILTER 74
- AUDIO SETUP 73
- AUTO PLAY 72
- AUTO POWER OFF 72
- AV SYNC 55

## B

- BACKGROUND 71
- Batteries 17
- BLACK LEVEL 71
- BLACK LEVEL  
(COMPONENT OUT) 71
- BNR 53

## C

- CD 8, 28
- CHAPTER 40
- Chapter 81
- CHAPTER VIEWER 41
- Checking the audio signal  
format 46
- Child Lock 29
- Connecting 18
- Continuous play
  - CD/VIDEOCD/Super Audio  
CD 28
  - DVD 28
- Control Menu 14
- CUSTOM 68
- CUSTOM PARENTAL  
CONTROL 62
- CUSTOM PICTURE MODE  
51
- CUSTOM SETUP 72

## D

- DATA CD 7, 56
- DATA DVD 7, 56
- DATE 59
- DCS (Digital Cinema Sound)  
48
- DIGITAL OUT 74
- Digital output 74

## DISPLAY 72

- Display
  - Control Menu Display 14
  - Front panel display 12
  - Setup Display 68
- DISTANCE 76
- DOLBY DIGITAL 45, 74, 81
- DOWNMIX 74
- DTS 45, 75, 81
- DVD 7, 28, 82
- DVD+RW 29, 82
- DVD's menu 31
- DVD-RW 7, 31, 82

## E

- EFFECT 61

## F

- Fast forward 38
- FAST PLAY 29
- Fast reverse 38
- FILE 40
- File 82
- File based software 21, 82
- FL OFF 72
- Freeze Frame 39
- Front panel display 12

## H

- Handling discs 2
- HDMI
  - AUDIO (HDMI) 73
  - HDMI 82
  - HDMI RESOLUTION 70
- Hooking up 17

## I

- INDEX 40
- Interlace format 82
- INTERVAL 61

## J

- JPEG 7, 56

## L

- LANGUAGE SETUP 69
- LEVEL 77
- Locating
  - a specific point by watching  
the TV screen 38

## M

- MEMORY 51
- MENU 69
- MNR 54
- MODE (MP3, JPEG) 60
- MP3 7, 56
- MULTI/2CH 32
- MULTI-DISC RESUME 30,

73

## N

- NORMAL (INTERLACE) 21
- Normal (Interlace) format 82

## O

- On-screen display
  - Control Menu Display 14
  - Setup Display 68
- ORIGINAL 31
- ORIGINAL/PLAY LIST 31
- OSD 69

## P

- PARENTAL CONTROL 62
- PAUSE MODE 72
- PBC Playback 33
- PICTURE NAVIGATION 41,  
59
- PLAY LIST 31
- PLAYBACK MEMORY 72
- PROGRAM 34
- Program Play 34
- PROGRESSIVE AUTO 21
- Progressive format 82
- PROGRESSIVE VIDEO 21

## Q

- QUICK 69
- Quick Setup 25, 69

## R

- Remote 13, 17, 65
- REPEAT 36
- Repeat Play 36
- REPLAY 29
- RESET 69

## S

- Scan 38
- SCENE 39
- SCREEN SAVER 71
- SCREEN SETUP 70
- Searching 38
- SETUP 68
- Setup Display 68
- SHARPNESS 52
- SHUFFLE 36
- Shuffle Play 36
- SIZE 76
- Slide Show 60
- SLOW PLAY 29
- Slow-motion Play 39
- SPEAKER SETUP 75
- Speakers
  - Hooking up 22
- SUBTITLE 50, 69
- Super Audio CD 7, 32, 83

SURROUND 46

## **T**

TEST TONE 77

TIME/TEXT 42

TITLE 40

Title 83

TITLE VIEWER 41

TOP MENU 31

TRACK 40

Track 12

TRACK SELECTION 72

TRACK VIEWER 41

Troubleshooting 78

TV TYPE 70

TVS 46

## **U**

Usable discs 8

## **V**

Video based software 21, 82

VIDEO CD 7, 28

VIDEO OFF 28

## **Z**

ZOOM 29, 59



Printed on 100% recycled paper using  
VOC (Volatile Organic Compound)-free  
vegetable oil based ink.



2-634-583-12 (1)