

**PROFESSIONAL SERIES  
ELECTRIC RANGETOP/RANGE WARRANTY  
ONE YEAR FULL WARRANTY**

Electric rangetops/Freestanding electric ranges and all of their component parts, except as detailed below\*, are warranted to be free from defective materials or workmanship in normal household use for a period of twelve (12) months from the date of original retail purchase. Viking Range Corporation, warrantor, agrees to repair or replace, at its option, any part which fails or is found to be defective during the warranty period.

\*Painted and decorative items are warranted to be free from defective materials or workmanship for a period of ninety (90) days from the date of original retail purchase. ANY DEFECTS MUST BE REPORTED TO THE SELLING DEALER WITHIN NINETY (90) DAYS FROM DATE OF ORIGINAL RETAIL PURCHASE.

**FIVE YEAR LIMITED WARRANTY**

Any halogen element, bake element, broil element, or convection cook element which fails due to defective materials or workmanship in normal household use during the second through fifth year from the date of original retail purchase will be repaired or replaced, free of charge for the part itself, with the owner paying all other costs, including labor.

**TEN YEAR LIMITED WARRANTY**

Any porcelain oven or porcelain inner door panel which rusts through due to defective material or workmanship in normal household use during the second through the tenth year from the date of original retail purchase will be repaired or replaced, free of charge for the part itself, with the owner paying all other costs, including labor.

**NINETY (90) DAY RESIDENTIAL PLUS WARRANTY** This warranty applies to applications where use of the product extends beyond normal residential use. Examples are, but not limited to, bed and breakfasts, fire stations, private clubs, churches, etc. This warranty excludes all commercial locations such as restaurants, food service locations and institutional food service locations.

This warranty extends to the original purchaser of the product warranted hereunder and to each transferee owner of the product during the term of the warranty.

This warranty shall apply to products purchased and located in the United States and Canada. Products must be purchased in the country where service is requested. Warranty labor shall be performed by an authorized Viking Range Corporation service agency or representative. Warranty shall not apply to items damaged when using the self-clean cycle such as oven racks and rack supports not removed during the self-clean cycle. Warranty shall not apply to damage resulting from abuse, accident, natural disaster, loss of electrical power to the product for any reason, alteration, outdoor use, improper installation, improper operation, or repair or service of the product by anyone other than an authorized Viking Range Corporation service agency or representative. This warranty does not apply to commercial usage. Warrantor is not responsible for consequential or incidental damage whether arising out of breach of warranty, breach of contract, or otherwise. Some jurisdictions do not allow the exclusion or limitation of incidental or consequential damages, so the above limitation or exclusion may not apply to you.

Owner shall be responsible for proper installation, providing normal care and maintenance, providing proof of purchase upon request, and making the appliance reasonably accessible for service. If the product or one of its component parts contains a defect or malfunction during the warranty period, after a reasonable number of attempts by the warrantor to remedy the defects or malfunctions, the owner is entitled to either a refund or replacement of the product or its component part or parts. Warrantor's liability on any claim of any kind, with respect to the goods or services covered hereunder, shall in no case exceed the price of the goods or service or part thereof which gives rise to the claim.

**WARRANTY SERVICE:** Under the terms of this warranty, service must be performed by a factory authorized Viking Range Corporation service agent or representative. Service will be provided during normal business hours, and labor performed at overtime or premium rates shall not be covered by this warranty. To obtain warranty service, contact the dealer from whom the product was purchased, an authorized Viking Range Corporation service agent, or Viking Range Corporation. Provide model and serial number and date of original purchase. For the name of your nearest authorized Viking Range Corporation service agency, call the dealer from whom the product was purchased or Viking Range Corporation. **IMPORTANT:** Retain proof of original purchase to establish warranty period.

The return of the Owner Registration Card is not a condition of warranty coverage. You should, however, return the Owner Registration Card so that Viking Range Corporation can contact you should any question of safety arise which could affect you.

Any implied warranties of merchantability and fitness applicable to the above described halogen element, bake element, broil element, convection cook element, porcelain oven, or porcelain inner door panel are limited in duration to the period of coverage of the applicable express written limited warranties set forth above. Some jurisdictions do not allow limitations on how long an implied warranty lasts, so the above limitation may not apply to you. This warranty gives you specific legal rights, and you may also have other rights which may vary from jurisdiction to jurisdiction.

VIKING RANGE CORPORATION  
111 Front Street • Greenwood, Mississippi 38930 USA • (662) 455-1200

Viking Range Corporation  
use & care manual

electric rangetops/ranges

Specifications subject to change without notice

For more product information, call 1-888-VIKING1 (845-4641), or visit the Viking web site  
F1484C at <http://www.vikingrange.com> (M0804VR)

## Congratulations . . .

Your purchase of this product attests to the importance you place upon the quality and performance of the major appliances you use. With minimal care, as outlined in this guide, this product is designed to provide you with years of dependable service. Please take the few minutes necessary to learn the proper and efficient use and care of this quality product.

We appreciate your choosing a Viking Range Corporation product, and hope that you will again select our products for your other major appliance needs.

## Table of Contents

Warnings . . . . .	3
Important Safety Instructions . . . . .	4
Cooking Utensils . . . . .	6
Before Your Use Your New Range . . . . .	7
Basic Functions of Your Oven . . . . .	7
Using Your Range . . . . .	8
Oven Operations . . . . .	17
Cleaning and Maintenance . . . . .	32
Self-Clean Cycle . . . . .	37
Power Failure . . . . .	39
Service Information . . . . .	40

**WARNING**  
If the information in this manual is not followed exactly, a fire or explosion may result causing property damage, personal injury or death.



**WARNING**

- THIS RANGE CAN TIP
- INJURY TO PERSONS COULD RESULT
- INSTALL ANTI-TIP DEVICE PACED WITH RANGE
- SEE INSTALLATION INSTRUCTIONS

**WARNING**

1. Read all instructions before using the product.
2. Install or locate the product only in accordance with the provided Installation Instructions.

## Important Safety Instructions

1. Your unit should be installed by a qualified technician. The appliance must be installed and electrically grounded according to local codes.
2. Do not attempt to repair or replace a part of this appliance unless specifically recommended in this manual. All servicing should be referred to a qualified technician. Warranty service must be performed by an authorized service agency.
3. The "push-to-turn" knobs of this range are designed to be child-safe. However, children should not be left alone in the kitchen while the range is in use. Do not store items of interest to children over the unit. **CAUTION:** Children climbing to reach items could be seriously injured.
4. GREASE is flammable and should be handled carefully. Do not use water on grease fires. Never pick up a flaming pan. Smother flaming pan by covering utensil completely with well-fitting lid, cookie sheet or flat tray. Flaming grease outside of utensil can be extinguished with baking soda or, if available, a multipurpose dry chemical or foam type extinguisher.
5. Never leave the surface area unattended at high heat setting. Boil-overs cause smoking and greasy spill-overs which may ignite.
6. If you are "flaming" liquor or other spirits under an exhaust, **TURN THE FAN OFF.** The draft could cause the flames to spread out of control.
7. Wear proper apparel. Loose-fitting or hanging garments should never be worn while using the appliance.
8. Never use your range for warming or heating a room. This is based on safety considerations.
9. Use proper pan size. Select utensils having flat bottoms large enough to cover the burner. Using undersized utensils allows the flame to come up the side of the utensil, scorching the outside of the utensil and making cleanup harder.

10. Use dry pot holders. Moist or damp pot holders on hot surfaces may result in burns from steam. Do not let potholder touch hot surface areas. Do not use a towel or other bulky cloth.
11. **DO NOT TOUCH SURFACE UNITS OR AREAS NEAR UNITS.** Surface areas may become hot enough to cause burns. Surface elements may be hot even though they are dark in color. During and after use, do not touch or let flammable materials contact heating elements until they have had time to cool.
12. To reduce the risk of burns, ignition of flammable materials, and spillage due to unintentional contact with the utensil, the handle of a utensil should be positioned so that it is turned inward toward the center of the range, and so that it does not extend over adjacent burners.
13. Keep area clean and free from combustible material, gasoline, and other flammable liquids. Never use your oven as a storage space. Combustible items (paper, plastic, etc.) may ignite and metallic items may become hot and cause burns.
14. A risk of tip-over may result if the appliance is not installed in accordance with installation instructions including excessive loading of the oven door or from abnormal usage.
15. Storage cabinet area above the unit must be 36" (91.4 cm) and cannot project more than 13" (33.0 cm) outward from the rear wall. Beware of potential hazards associated with retrieving items from such cabinets when the unit is in operation.
16. Do not heat unopened food containers; buildup of pressure may cause the container to explode and result in injury.
17. Never sit, step, stand, or lean on any part of the oven, or injury may result.
18. Use care when opening oven door. Let hot air or steam escape before removing or replacing food. Always position oven racks in desired location while oven is cool. If rack must be moved while oven is hot, do not let potholder contact hot heating element in oven.
19. Do not clean door gasket. It is essential for a good, tight seal. Care should be taken not to rub, damage, or move the gasket.
20. No commercial oven cleaner or oven liner protective coating of any kind should be used in or around any part of the oven.

21. Before self-cleaning the oven, remove broiler pan, broiler grid, oven racks, rack supports, and other utensils. Do not use your oven to clean other parts. A fan noise should be heard sometime during the cleaning cycle, if not, call service before self-cleaning again.  
**WARNING:** When self-cleaning, surfaces may get hotter than usual, therefore, children should be kept away.
22. **DO NOT TOUCH HEATING ELEMENTS OR INTERIOR SURFACES OR OVEN.** Heating elements may become hot even though they are dark in color. Interior surfaces of an oven become hot enough to cause burns. During and after use, do not touch, or let clothing or other flammable materials contact heating elements or interior surfaces of oven until they have had sufficient time to cool. Other surfaces of the oven may become hot enough to cause burns, such as the oven vent opening, the surface near the vent opening, and the oven door window.
23. Clean rangetop with caution. If a wet sponge or cloth is used to wipe spills on hot cooking area, be careful to avoid steam burn. Some cleansers can produce noxious fumes if applied to hot surface.
24. Do not cook on a broken rangetop. Spillovers or cleaning solution may penetrate a broken glasstop and create a risk of electrical shock. Contact a qualified technician immediately should your rangetop become broken.

## Before You Use Your New Range

All products are wiped clean with solvents at the factory to remove any visible signs of dirt, oil, and grease which may have remained from the manufacturing process. Before starting to cook, clean the range thoroughly with hot, soapy water.

### Glass Rangetop

Clean your glass top before the first time you use it. A thorough cleaning with a glass top cleaner is recommended. It only takes a minute and puts a clean, shiny coating on the glass top before its initial use.

### Drip Tray/Pan

The drip tray should be pulled out and checked for flammable materials. Make sure to unwrap the drip pan and replace it in its proper place under the griddle or grill (if applicable).

### Oven

Before first use, wipe interior with soapy water and dry thoroughly.

## Surface Cooking Cooking Utensils

Each cook has his or her own preference for the particular cooking utensils that are most appropriate for the type cooking being done. Only certain types of glass, glass/ceramic, earthen ware, or other glazed utensils are suitable for glass rangetop use without breaking due to the sudden change in temperature. As with any cookware, yours should be in good condition and free from excessive dents on the bottom to provide maximum performance and convenience.

### CAUTION

Using cast iron cookware on the glass rangetop is not recommended. Cast iron retains heat and may result in rangetop damage

## Cooking Utensil Guidelines

Type	Response to temp. Changes	Recommended Usage
Aluminum	Heats and cools quickly	Frying, Braising, Roasting May leave metal markings on rangetop
Cast Iron	Heats and cools quickly	Not recommended. Retains excessive heat and may damage rangetop.
Copper, tin lined	Heats and cools quickly	Gourmet cooking, wine sauces, egg dishes.
Enamelware	Response depends on base metal	Not recommended. Heats too slowly. Imperfections in enamel may scratch rangetop.
Glass Ceramic	Heats and cools slowly	Not recommended. Heats too slowly. Imperfections in glass may scratch rangetop.
Stainless Steel	Heats and cools at moderate rate	Soups, sauces, vegetables, general cooking.

### Operating the Single Front or Rear Element

Push in and turn the control knob counterclockwise to the desired setting. The element will cycle on and off to maintain the desired heat setting. When finished, turn all controls to OFF.

### Operating the Rear and Bridge Element

Push in and turn the right rear control knob clockwise to the desired setting. The rear element and the bridge element will cycle on and off to maintain the desired heat setting. When finished, turn all controls OFF.

### Hot Surface Indicator Lights

The range has four hot surface indicator lights. They are located in the center of the glass rangetop. The hot surface indicator light will glow red when the corresponding element is turned on. The light will remain on after turning off the control knob until the corresponding element has cooled to a safe temperature.

## Surface Cooking Guide - Suggested Heat Settings

Food	Start at Setting	Complete at Setting
Rice	HI - cover; bring water to a boil	LO - cover; finish timing according to directions
Chocolate	LO - allow about 10 to 15 minutes to melt	
Candy	LO - cook	Follow recipe
Pudding, pie filling	LO - cook according to directions	
Eggs - in shell	HI - cover; bring to boil	OFF- let set to desired doneness
Fried	HI - melt butter; add eggs	LO - 2; cook to desired doneness
Poached	HI - bring water to boil; add eggs	LO - finish cooking
Sauces	HI - melt fat	LO - 2; finish cooking
Soup, stews	HI - heat up liquid	LO - 2; finish cooking
Vegetables Fresh, frozen	HI - cover; bring salted water to boil	LO - 2; finish cooking until desired tenderness is reached
Vegetables, fried	HI - preheat skillet and oil	LO - 2; cook until desired tenderness is reached
Breads, french toast, pancakes	4 - 5; preheat skillet 4-8 minutes	4 - 5; cook to desired brownness
Cereals Grits, oatmeal	HI - cover; bring water to boil	LO - 2; add cereal and cook according to directions
Bacon, sausage	HI - cook until just starting to sizzle	4 - 5; finish cooking
Swiss steak	HI - melt fat, 4 - 5 brown meat	LO - add liquid, cover simmer until tender
Chicken, fried	HI - melt fat, 4 - 5, brown crust	LO - cook until tender
Hamburgers, Pork chops	HI - preheat skillet	4 - 5, brown meat; cook to desired doneness
Pastas - Macaroni, Noodles, Spaghetti	HI - bring salted water to boil; add pasta slowly	4 - 5, maintain a rolling boil, cook until tender

## Cooking Substitute Charts

In many cases, a recipe requires an ingredient which is not readily available or calls for a unit of measure that is not easily recognized. The following charts have been provided as useful guides in these situations.

Ingredient Substitutes	
Recipe calls for:	Use:
1 Tbsp. Cornstarch	2 Tbsp. flour (thickening)
1 whole egg	2 egg yolks plus 1 Tbsp. water
1 c. whole milk	1 c. skim milk plus 2 Tbsp. margarine or 1/2 c. evaporated milk plus 1/2 c. water
1 oz unsweetened chocolate	3 Tbsp. cocoa powder plus 1 Tbsp. margarine
1 Tbsp. baking powder	1/2 tsp. cream of tartar plus 1/4 tsp. baking soda
1/2 c. butter	7 Tbsp. margarine or shortening
1 c. dairy sour cream	1 Tbsp. lemon juice plus 1 c. evaporated milk

Canned Food Sizes			
Sizes	Contents	Sizes	Contents
8 oz	1 cup	No. 303	2 cups
Picnic	1 3/4 cups	No. 2	2 1/2 cups
No. 300	1 3/4 cups	No. 3	4 cups
No. 1 tall	2 cups	No. 10	12 cups

### Kitchen Equivalents and Metrics

Measure	Equivalent	Metric*
1 tablespoon	3 teaspoons	15 mL
2 tablespoons	1 ounce	30 mL
1 jigger	1 1/2 ounces	45 mL
1/4 cup	4 tablespoons	60 mL
1/3 cup	5 tbsp. plus 1 tsp.	80 mL
1/2 cup	8 tablespoons	125 mL
1 cup	16 tablespoons	250 mL
1 pint	2 cups	30 grams
1 pound	16 ounces	454 grams
2.21 pounds	35.3 ounces	1 kilogram

\*Rounded for easier measuring

## Basic Functions of Your Oven

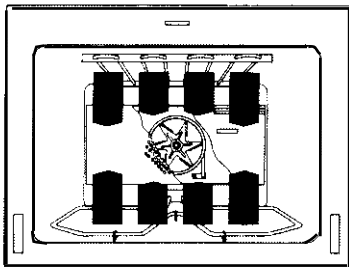

### TWO-ELEMENT BAKE

Full power heat is radiated from the bake element in the bottom of the oven cavity and partial heat is radiated from the broil element in the top. Air is circulated with natural airflow. This is your traditional bake setting.

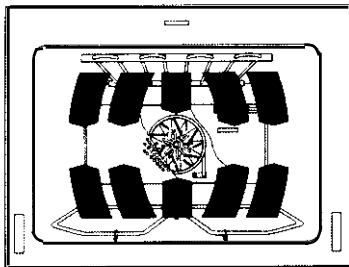

### CONVECTION BAKE

Heat is radiated from the bake element in the bottom of the oven cavity and is circulated by the motorized fan in the rear of the oven. It provides more even heat distribution throughout the oven cavity for all uses. Multiple rack use is possible for the largest baking job. When roasting, cool air is quickly replaced - searing meats on the outside and retaining more juices and natural flavor on the inside with less shrinkage.

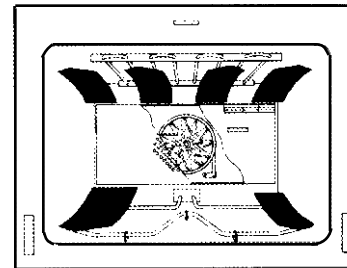

### TruConvec™

The rear element only operates at full power. Air is circulated by the fan for even heating. Use this setting for foods which require gentle cooking such as pastries and souffles.

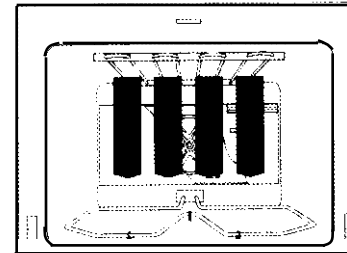

### BROIL

In Maxi-Broil, heat is radiated from both broil elements, located at the top of the oven cavity at full power. Broiling speed is determined by the distance between the foods and the broil elements. The Mini-Broil setting is designed for "slow" broiling. ONLY the center broil element operates for partial power.

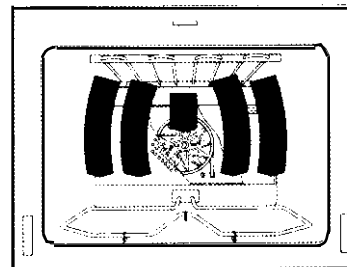

### CONVECTION BROIL

Exactly the same as regular broiling with the additional benefit of air circulation by the motorized fan in the rear of the oven. The cool air is quickly replaced-improving the already high performance of the broil element.

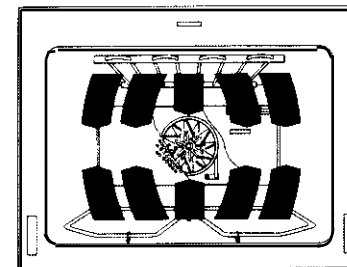

### SELF-CLEAN

This range features an automatic pyrolytic self-cleaning cycle. During this cycle, the oven reaches elevated temperatures in order to burn off soils and deposits. An integral smoke eliminator reduces odors associated with the soil burn-off. A powder ash residue is left in the bottom of the oven after completion of the self-clean cycle. When oven has cooled, remove ash with a damp sponge or cloth.

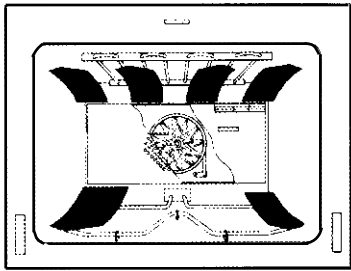

### CONVECTION DEHYDRATE

With the temperature control on 175°F (79.4 °C), warm air is radiated from the bake element in the bottom of the oven cavity and is circulated by a motorized fan in the rear of the oven. Over a period of time, the water is removed from the food by evaporation. Removal of water inhibits growth of microorganisms and retards the activity of enzymes. It is important to remember that dehydration does not improve the quality, so only fresh, top-quality foods should be used.

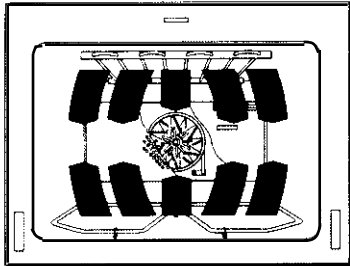

### CONVECTION DEFROST

With temperature control off, air is circulated by a motorized fan in the rear of the oven. The fan accelerates natural defrosting of the food without heat. To avoid sickness and food waste, do not allow defrosted food to remain in the oven for more than two hours.

## Oven Operation

### Oven Function Selector

Each oven has an oven function selector. There are five settings on the selector.

- Bake: Heat is radiated from the bake element in the bottom of the oven cavity and is circulated with natural airflow. This is your traditional bake setting. Use this setting for baking and roasting on a single rack, preferably in the center of the oven.

- Convection Bake: Heat is radiated from the bake element in the bottom of the oven cavity and is circulated by the motorized fan in the rear of the oven. It provides more even heat distribution throughout the oven cavity for all uses. Multiple rack use is possible for the largest baking job.

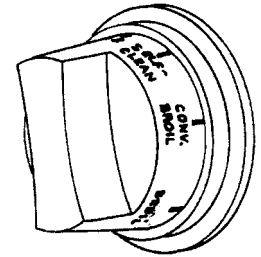

- TruConvect™: An element located around the fan in the rear of the oven is the only heat source.
- Maxi-Broil: The broil element at the top of the oven operates at full power.
- Mini-Broil: Only the center broil element operates for partial power. The setting is designed for "slow" broiling.
- Convection Broil: Exactly the same as regular broiling with the additional benefit of air circulation by the motorized fan in the rear of the oven. The cool air is quickly replaced-improving the already high performance of the infrared broil burner.
- Self-Clean: This range features an automatic pyrolytic self-cleaning cycle. During this cycle, the oven reaches elevated temperatures in order to burn off soils and deposits. An integral smoke eliminator reduces odors associated with the soil burn-off.

### Temperature Controls

Each oven has a temperature control dial. The control can be used to be set at any temperature from 150°F to 550°F, broil, or self-clean. Always be sure the controls are in the "Off" position when the oven is not in use.

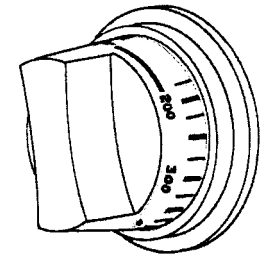

## Two-Element Baking/ Convection Baking

### Preheating

Preheating the oven is not necessary when using temperatures below 250°F. For best results, it is extremely important that you preheat the oven when baking cakes and other items that have critical baking temperatures. After the temperature control has been set, the Oven Indicator light goes out when the oven reaches that temperature. Preheating takes no longer than 10-15 minutes.

### Two-Element Baking

This conventional baking/roasting is particularly suitable for dishes which require a high temperature. Many cookbooks contain recipes to be cooked in the conventional manner. This bake setting is only recommended for single-rack baking.

### Convection/TruConvect™ Baking

Convection baking is the process of cooking food with a flow of heated air circulating throughout the oven cavity. The even circulating of this air equalizes the temperature throughout the oven cavity and eliminates the hot and cold spots found in conventional ovens. This feature can make a significant difference in foods prepared in the oven. A major benefit of convection baking is the ability to prepare food in quantity. The uniform air circulation makes this possible . . . a feature not possible in a standard oven. With this heating system, the air is distributed evenly throughout the oven by the hot air fan. The heat therefore reaches the food to be baked or roasted more quickly. With this heating method, foods can be baked and roasted at the same time with minimal taste transfer, even when different dishes are involved, such as cakes, fish, or meat. The hot air system is especially economical when thawing frozen food.

### Rack Positions

Each convection oven is equipped with three tilt-proof racks, and each convectional oven is equipped with two-tilt proof racks. All ranges have six rack positions. Position 6 is the farthest from the oven bottom. Position 1 is the closest to the oven bottom. The racks can be easily removed and arranged at various levels. For best results with conventional baking, do not use more than one rack at a time. It is also recommended when using two racks, to bake with the racks on position 3 and 5.

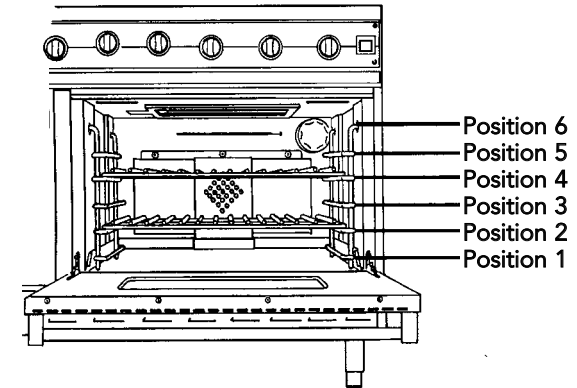

### To Bake:

1. Arrange the oven racks in the desired position BEFORE heating the oven. If cooking on two racks at the same time, use rack positions 3 and 5.
2. Turn the Oven Function selector to desired function. Cooking starts immediately and stops when the Oven Function selector is turned to OFF.
3. Set the Temperature Control to the desired temperature.
4. Place the food in the oven after the Oven Indicator light goes out.

## Pan Placement Tips

- When using large (15" x 13" [38 cm x 33 cm]) flat pans or trays that cover most of the rack, rack positions 2 or 3 produce the best results.
- Stagger pans in opposite directions when two racks and several pans are used. No pan should be directly above another.
- Allow 1 1/2" to 2" (3.8 cm to 5.1 cm) of air space around all sides of each pan for even air circulation.
- When baking on more than one rack, it is recommended to use the 3rd and 5th position for more consistent even baking.

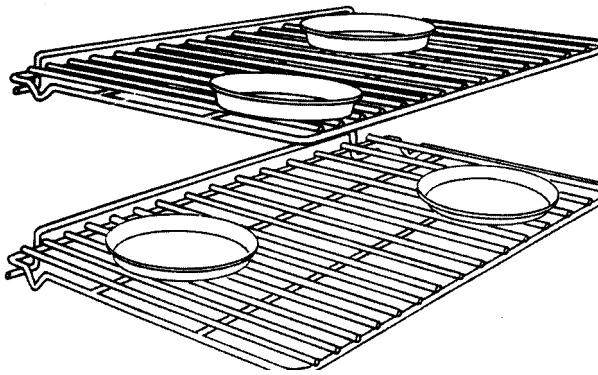

## Baking Tips

- As a general rule, to convert conventional recipes to convection recipes, reduce the temperature by 25°F and the cooking time by approximately 10 to 15%.
- Some recipes, especially those that are homemade, may require adjustment and testing when converting from standard to convection modes. If unsure how to convert a recipe, begin by preparing the recipe in conventional bake. After achieving acceptable results, follow the convection guidelines listed for the similar food type. If the food is not prepared to your satisfaction during the first convection trial, adjust only one recipe variable at a time (cooking time, rack position, or temperature) and repeat the convection test. Continue adjusting one recipe variable at a time until satisfactory results are achieved.
- Make sure the oven racks are in the desired positions before you turn the oven on.
- For best results, always preheat the oven.
- Do not open the oven door frequently during baking. If you must open the door, the best time is during the last quarter of the baking time.
- Bake to shortest time suggested and check for doneness before adding more time. For baked goods, a stainless steel knife placed in the center of the product should come clean when done.
- Use good quality baking pans and sizes recommended in the recipe; warped, dented, or burned pans should not be used.
- Shiny metal pans are preferred for baking items such as cakes, cookies, and muffins because they produce light, golden crusts due to heat being reflected by the metal.
- Glass pans may also be used for cake baking. Reduce the oven temperature by 25 degrees when using a glass pan, but bake for the same amount of time called for in the recipe.
- Pies are best baked in pans which absorb and hold heat. Glass, enamel, dull-finished metal, and porcelain enamel finish give pies a golden brown crust.

## Conventional Baking Chart

	Recommended Pan	Conventional Temperature		Conventional Time (min.)
		(°F)	(°C)	
<b>BREADS</b>				
Yeast Loaf	Loaf Pan	375	191	30-35
Yeast Rolls	Cookie Sheet	400	204	12-15
Biscuits	Cookie Sheet	400	204	8-10
Nut Breads	Loaf Pan	375	191	30-35
Cornbread	8"x8" (20x20 cm)	400	204	25-30
Corn Muffins	Muffin Tin	375	191	15-20
Fruit Muffins	Muffin Tin	475	191	15-20
<b>CAKES/COOKIES</b>				
Angelfood	Tube Pan	375	191	35-45
Bundt	Tube Pan	350	177	45-50
Cupcakes	Muffin tin	350	177	16-20
Layer, Sheet	13"x9" (23x33 cm)	350	177	40-50
Layer, Two	9" (23 cm) round	350	177	30-35
Pound	Loaf Pan	350	177	60-65
Brownies	13"x9" (23x33 cm)	350	177	25-30
Choc. Chip	Cookie Sheet	375	191	12-15
Sugar Cookies	Cookie Sheet	350	177	10-12
<b>PIES/PASTRY</b>				
Pie Crust	9" (23 cm) round	425	218	10-12
Two Crust, Fruit	9" (23 cm) round	375	191	55-60
Pumpkin Pie	9" (23 cm) round	375	191	40-45
Custard	6 - 4 oz cups	350	177	35-40
Cream Puffs	Cookie Sheet	400	204	30-35
<b>MISCELLANEOUS</b>				
Baked Potatoes	(4) 8 oz (227 gm)	375	191	60-75
Lasagna	9"x5" (23x13 cm)	375	191	55-60
Cheese Souffle	1 qt. (.95 L)	350	177	45-50
Stuffed Peppers	13"x9" (23x33 cm)	375	191	60-70
Quiche	9" (23 cm) round	400	204	25-30

\*NOTE: The above information is given as guide only. You may need to vary the heat settings to suit your personal requirements

## Convection Baking Chart

	Recommended Pan	Convection Temperature		Convection Time (min.)
		(°F)	(°C)	
<b>BREADS</b>				
Yeast Loaf	Loaf Pan	350	177	25-35
Yeast Rolls	Cookie Sheet	375	191	11-13
Biscuits	Cookie Sheet	375	191	7-9
Nut Breads	Loaf Pan	350	177	20-25
Cornbread	8"x8" (20x20 cm)	375	191	15-20
Corn Muffins	Muffin Tin	350	177	10-12
Fruit Muffins	Muffin Tin	350	177	12-15
<b>CAKES/COOKIES</b>				
Angelfood	Tube Pan	325	163	30-35
Bundt	Tube Pan	325	163	35-40
Cupcakes	Muffin tin	325	177	15-17
Layer, Sheet	13"x9" (23x33 cm)	325	163	30-35
Layer, Two	9" (23 cm) round	325	163	25-30
Pound	Loaf Pan	325	163	45-50
Brownies	13"x9" (23x33 cm)	325	163	20-25
Choc. Chip	Cookie Sheet	350	177	9-10
Sugar Cookies	Cookie Sheet	325	163	7-10
<b>PIES/PASTRY</b>				
Pie Crust	9" (23 cm) round	400	204	7-9
Two Crust, Fruit	9" (23 cm) round	350	177	50-55
Pumpkin Pie	9" (23 cm) round	350	177	35-40
Custard	6 - 4 oz cups	Not Recommended		
Cream Puffs	Cookie Sheet	375	191	25-27
<b>MISCELLANEOUS</b>				
Baked Potatoes	(4) 8 oz (227 gm)	350	177	50-55
Lasagna	9"x5" (23x13 cm)	350	177	45-50
Cheese Souffle	1 qt. (.95 L)	325	163	35-40
Stuffed Peppers	13"x9" (23x33 cm)	350	177	45-50
Quiche	9" (23 cm) round	Not Recommended		

\*NOTE: The above information is given as guide only. You may need to vary the heat settings to suit your personal requirements

## Solving Baking Problems

Baking problems can occur for many reasons. Check the chart for the causes and remedies for the most common problems. It is important to remember that the temperature setting and cooking times you are accustomed to using with your previous oven may vary slightly from those required with this oven. If you find this to be true, it is necessary for you to adjust your recipes and cooking times accordingly.

BAKING PROBLEM REMEDIES		
PROBLEM	CAUSE	REMEDY
Food browns unevenly	Improper heating  Aluminum foil on rack or oven bottom Baking utensils too large for the recipe or oven. Several utensils crowded together	Preheat until oven indicator light goes out. Remove foil.  Use correct size utensil.  Leave at least 1 1/2" (3.8 cm) or more space between all utensils and oven walls.
Food too brown on bottom	Baking utensil too large Baking utensil dark or glass	Use correct utensil Lower oven temperature 25°F (-3.8 °C) for this type of utensil.
Food dries before browning	Oven temperature too high Oven door opened too frequently	Lower oven temperature Check food at minimum time.
Cookies too brown on	Pans too deep  Dark cookie sheet  Oven temperature too high	Use a cookie sheet (not a baking pan). Use light, shiny cookie sheet. Lower oven temperature
Cookies too flat	Hot cookie sheet	Allow cookie sheet to cool between batches.
Cake too brown on bottom or crust forms on bottom	Oven temperature too high	Lower temperature; if using glass pan, lower 25°F (-3.8 °C)
Cakes burns on sides or not done in center than	Oven too hot Wrong pan size	Reduce temperature. Use recommended pan size; fill pan no more 2/3 full.

## Conventional/Convection Roasting Tips

Always use the broiler pan and grid supplied with each oven. The hot air must be allowed to circulate around the item being roasted. Do not cover what is being roasted. Convection roasting seals in juices quickly for a moist, tender product. Poultry will have a light, crispy skin, and meats will be browned, not dry or burned. Cook meats and poultry directly from the refrigerator. There is no need for meat or poultry to stand at room temperature.

- Always roast meats fat side up. No basting is required when the fat side is up. Do not add water to the pan, as this will cause a steamed effect. Roasting is a dry-heat process.
- Poultry should be placed breast side up on the grid in the broiler pan. Brush poultry with melted butter, margarine, or oil before and during roasting.
- For convection roasting, do not use pans with tall sides, as this will interfere with the circulation of heated air over the food.
- If using a cooking bag, foil tent, or other cover, use conventional baking rather than convection.
- When using a meat thermometer, insert the probe halfway into the center of the thickest portion of the meat. (For poultry, insert the thermometer probe between the body and leg into the thickest part of the inner thigh.) The tip of the probe should not touch bone, fat, or gristle to ensure an accurate reading. Check the meat thermometer 2/3 of the way through the recommended roasting time. After reading the thermometer once, insert it 1/2" (1.3 cm) further into the meat, then take a second reading. If the second reading registers below the first, continue cooking the meat.
- Roasting times always vary according to the size, shape, and quality of meats and poultry. Less tender cuts of meat are best prepared in the conventional bake setting and may require moist cooking techniques. Remove roasted meats from the oven when the thermometer registers 5°F to 10°F (-15°C to -12°C) lower than the desired doneness. The meat will continue to cook after removal from the oven. Allow roasts to stand 15 to 20 minutes after roasting in order to make carving easier.

## Conventional Roasting Chart

Type and Cut of Meat	Weight (lbs)	Conventional Temperature		Conventional Time (min./lb.)	Internal Temperature	
		(°F)	(°C)		(°F)	(°C)
<b>BEEF</b>						
Rib Roast	4 - 6	325	163			
•Rare				25	140	60
•Medium				30	155	68
•Well Done				40	170	77
Rump Roast	4 - 6	325	163			
•Medium				25	155	68
•Well Done				30	170	77
Tip Roast	3 - 4	325	163			
•Medium				35	155	68
•Well Done				40	170	77
<b>LAMB</b>						
Leg of Lamb	3 - 5	325	163	30	180	82
<b>PORK</b>						
Pork Loin	3 - 5	325	163	35	180	82
Pork Chops						
1" (2.5 cm) thick	1 - 1.5	350	177	55-60 (total time)	180	82
Shoulder (Bone-in)	5 - 8	325	163	30 - 35	180	82
Ham, (fully cooked)	5	325	163	18	140	60
<b>POULTRY</b>						
Chicken, whole	3 - 4	375	191	30	180	82
Chicken, quarters	4	350	177	20 - 25	180	82
Turkey, unstuffed	12 - 16	325	163	16 - 20	180	82
Turkey, stuffed	12 - 16	325	163	18 - 24	180	82
Turkey Breasts	4 - 6	350	177	25	180	82
Cornish Hens	1 - 2	350	177	55-60 (total time)	180	82

## Convection Roasting Chart

Type and Cut of Meat	Weight (lbs)	Convection Temperature		Convection Time (min./lb.)	Internal Temperature	
		(°F)	(°C)		(°F)	(°C)
<b>BEEF</b>						
Rib Roast	4 - 6	300	149			
•Rare				20	140	48
•Medium				24	155	68
•Well Done				30	170	77
Rump Roast	4 - 6	300	149			
•Medium				20	155	68
•Well Done				24	170	77
Tip Roast	3 - 4	300	149			
•Medium				30	155	68
•Well Done				35	170	77
<b>LAMB</b>						
Leg of Lamb	3 - 5	300	149	30	180	82
<b>PORK</b>						
Pork Loin	3 - 5	300	149	30	180	82
Pork Chops						
1" (2.5 cm) thick	1 - 1.5	325	163	45-50 (total time)	180	82
Shoulder (Bone-in)	5 - 8	300	149	25 - 28	180	82
Ham, (fully cooked)	5	325	163	15	140	60
<b>POULTRY</b>						
Chicken, whole	3 - 4	350	177	25	180	82
Chicken, quarters	4	325	163	15 - 20	180	82
Turkey, unstuffed	12 - 16	300	149	11 - 14	180	82
Turkey, stuffed	12 - 16	300	149	10 - 16	180	82
Turkey Breasts	4 - 6	325	163	20	180	82
Cornish Hens	1 - 2	325	163	45-50 (total time)	180	82

## Conventional Broiling

Broiling is a dry-heat cooking method using direct or indirect radiant heat. It is used for small individualized cuts such as steaks, chops, and patties. Broiling is most successful for cuts 1-2 inches (2.54-5.1 cm) thick. Conventional broiling is also more suitable for flat pieces of meat. Your oven contains a top broil element to provide additional flexibility for broiling foods such as "stuffed lobster" and for top-browning casseroles, meringue, etc. Broiling speed is determined by the distance between the food and the broil element. On maxi-broil heat is radiated from both broil elements at full power. For "fast" broiling, food may be as close as two inches to the broil element. "Fast" broiling is best for meats where "rare to medium" doneness is desired. The mini-broil setting is designed for "slow" broiling. For "slow" broiling, allow about four inches between the top surface of the food and the broil element. "Slow" broiling is best for chicken and ham in order to broil food without overbrowning it.

## Convection Broiling

Convection broiling has the advantage of broiling food slightly quicker than conventional. Convection broiling of meats produces better results especially for extra thick cuts. The meat sears on the outside and retains more juices and natural flavor inside with less shrinkage.

### Rack Positions:

The broiler uses infrared heat rays to help cook the food. Because these rays can travel only in straight lines, the effective cooking area of the broiler is reduced when using the higher rack positions. At high rack positions, the rays cannot reach all corners of the broiler grid, so larger pieces of meat might not broil sufficiently at the outer edges. Position 6 is the closest to the broiler and position 1 is the closest to the oven bottom. The effective cooking areas on the broiler grid for each rack position are as follows:

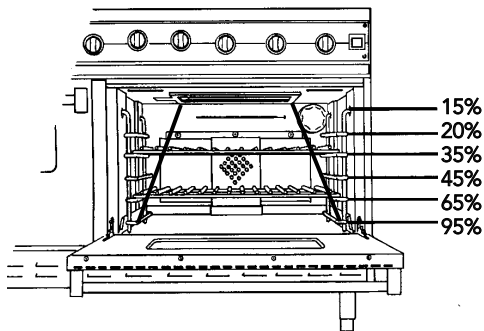

### To use the Maxi-Broil or Mini-Broil:

1. Arrange the oven racks in the desired position.
2. Center food on cold broiler pan and grid supplied with your oven. Place broiler pan in oven and close the door.
3. Set the Oven Function selector to either MAXI-BROIL, MINI-BROIL, or CONV BROIL.
4. Set the Temperature Control dial to BROIL.
5. Either open the door to an open position approximately seven to eight inches or close the door. With open-door broiling, the broil element does not cycle on and off. With closed-door broiling, the broil element might cycle on and off if an extended broiling time is required. A built-in smoke "eliminator" in the top of the oven helps reduce smoke and odors.

### Broiling Tips

- Always use a broiler pan and grid for broiling. They are designed to provide drainage of excess liquid and fat away from the cooking surface to help prevent spatter, smoke and fire.
- Place broiler pan with food in recommended rack position.
- To keep meat from curling, slit fatty edge.
- Brush chicken and fish with butter several times as they broil to prevent drying out. To prevent sticking, lightly grease broiler grid.
- Broil on first side for slightly more than half the recommended time, season and turn. Season second side just before removing.
- Always pull rack out to stop position before turning or removing food.
- Use tongs or a spatula to turn meats. Never pierce meat with a fork as this allows the juices to escape.
- Remove the broiler pan from the oven when you remove the food. Drippings will bake onto the pan if it is left in the heated oven after broiling. While pan is hot, place damp paper towel over grid. Drizzle with liquid dishwashing detergent and pour water over grid. This will make cleaning of the pan easier, or the broiler pan can be lined with aluminum foil to make cleaning easier. Be sure the foil extends up the side of the pan. Although it is not recommended, the grid can also be covered with foil. Be sure to slit openings to conform with the openings in the grid so melted fat can drain through to prevent spattering, smoking or possibility of grease fire.

## Conventional/Convection Broiling Chart

Type and Cut of Meat	Weight	Rack	Conventional Time (Min.)	Convection Time (Min.)
<b>BEEF</b>				
Sirloin, 1" (2.54 cm)	12 oz	5		
•Rare			9	7
•Medium			11	9
•Well-done			14	11
T-Bone, 3/4" (1.9 cm)	10 oz	5		
•Rare			7	5
•Medium			9	7
•Well-done			11	9
Hamburger, 1/2" 4 oz. (1.3 cm)		5		
•Rare			7	4
•Medium			9	7
•Well-done			11	9
<b>CHICKEN</b>				
Bnls Breast	1lb	4	18	15
Bone-in Breast	2 - 2 1/2 lb.	4	20	18
Quarters	2 - 2 1/2	4	18	15
<b>HAM</b>				
Ham slice, 1" (2.54 cm)	1lb.	4	22	18
<b>LAMB</b>				
Rib Chops	12 oz.	5	9	7
Shoulder	1lb.	5	7	6
<b>PORK</b>				
Loin Chops, 3/4" (1.9 cm)	1lb.	4	14	12
Bacon	1 lb.	4	8	6
<b>FISH</b>				
Salmon Steak	1 lb.	5	9	7
Filletts	1 lb.	5	8	6

## Convection Dehydration

This oven is designed not only to cook, but also to dehydrate fruits and vegetables.

- Prepare the food as recommended.
- Arrange the food on drying racks. (Not included with oven; Contact a local store handling specialty cooking utensils.)
- Set the appropriate "low" temperature and turn the Oven Function selector to CONV BAKE

## Convection Defrosting

- Place the frozen food on a baking sheet.
- Set Temperature Control "OFF".\*
- Turn Oven Function selector to CONV BAKE.

### \*IMPORTANT:

Do not turn the Temperature Control on. Turning the convection fan on will accelerate the natural defrosting of the food without the heat.

### \*WARNING:

To avoid sickness and food waste, do not allow defrosted food to remain in the oven for more than two hours.

## Cleaning and Maintenance

Any piece of equipment works better and lasts longer when maintained properly and kept clean. Cooking equipment is no exception. Your range must be kept clean and maintained properly.

### Glass Ceramic Top

Cleaning of glass ceramic tops is different from cleaning a standard porcelain finish. To maintain and protect the surface of your new glass ceramic top, follow these basic steps:

For normal light soil:

Rub a few drops of a glass ceramic creame to the cool soiled area using a damp paper towel. Wipe until all soil and creame are removed. Frequent cleaning leaves a protective coating which is essential in preventing scratches and abrasions.

For heavy, burned soil:

1. Apply a few drops of glass ceramic cleaning creame to the cool soiled area.
2. Using a damp paper towel, rub creame into burned on area.
3. Carefully scrape remaining soil with a razor scraper. Hold the scraper at a 30° angle against the ceramic surface.
4. If any soil remains, repeat the steps listed above. For additional protection, after all soil has been removed, polish the entire surface with the cleaning creame.
5. Buff with a dry paper towel. As the cleaning creame cleans, it leaves a protective coating on the glass surface. This coating helps to prevent build-up of mineral deposits (water spots) and will make future cleaning easier. Dishwashing detergents remove this protective coating and therefore make the glass ceramic top more susceptible to staining.

## Cleaning Problems on Glass Ceramic Top

Problem	Cause	To Prevent	To Remove
Brown streaks and specks	Cleaning with sponge or cloth containing soil-laden detergent water	Use cleaning creame with clean damp paper towel	Use a light application of cleaning creame with a clean damp paper towel
Blackened burned on spots	Spatters or spillovers onto a hot cooking area or accidental melting of a plastic film, such as a bread	Wipe all spillovers as soon as it is safe and to not put plastic items on a warm cooking area	Clean area with cleaning creame and a damp paper towel, non-abrasive nylon pad or scouring brush. If burn-on is not removed, cool cooktop, and carefully scrape area with a single edged razor blade held at a 30° angle.
Fine brown/gray lines or fine scratches or abrasions which have collected soil	Coarse particles (salt sugar) can get caught on the bottom of cookware and become embedded into top. Using abrasive cleaning materials. Scratches from rough ceramic glass, or ceramic coated cookware.	Wipe the bottom of cookware before cooking. Clean top daily with cleaning creame. Do not use ceramic or ceramic coated cookware.	Fine scratches are not removable but can be minimized by daily use of cleaning creame.
Smearing or streaking	Use of too much cleaning creame or use of a soiled dishcloth	Use a small amount of creame. Rinse thoroughly before drying. Use only paper towels or nylon scrub pad or brush.	Dampen paper towel with a mixture of vinegar and water and wipe surface. Wipe area with damp paper towel and dry with a paper towel or lint free cloth.
Metal markings silver/gray marks	Sliding or scraping metal utensils on glasstop	Do not slide metal objects across top	Remove metal marks before the glasstop is used again. Apply cleaning creame with a damp paper towel and scrub with a nylon scrub pad or brush. Rinse thoroughly and dry.
Hard water spots	Condensation from cooking may cause minerals found in water and acids to drip on glasstop and cause gray deposits. The spots are often so thin they appear to be in or the glasstop.	Make sure the bottom of utensils are dry before cooking. Daily use of cleaning creame will help keep top free from hard water mineral deposits and food discoloration	Mix cleaning creame with water and apply a thick paste to stained area. Scrub vigorously. If stain is not removed, reapply cleaner and repeat process. Also try cleaning procedure for smearing and streaking.
Pitting or flaking	Boil over of sugar syrup on glasstop. This can cause pitting if not removed immediately	Watch sugar and syrups carefully to avoid boilovers.	Turn element to LO; using several paper towels to wipe the spill immediately. Let glasstop cool and carefully scrape off remainder of burn-off with a single edged razor held at a 30° angle.

## Oven Surfaces

Several different finishes have been used in your self-clean oven. Cleaning instructions for each surface are given below. Your oven features a self-clean cycle for the oven interior. See the self-clean section for complete instructions.

**NEVERS USE AMMONIA, STEEL WOOL PADS, ABRASIVE CLOTHS, ABRASIVE CLEANERS, CAUSTIC OVEN CLEANERS, OR ABRASIVE POWDERS. THEY CAN PERMANENTLY DAMAGE YOUR OVEN.**

## Control Knobs

MAKE SURE THE CONTROL KNOBS POINT TO THE OFF POSITION BEFORE REMOVING. Pull the knobs straight off. Wash in detergent and warm water. Do not soak knobs. Dry completely and replace by pushing firmly onto stem. DO NOT USE any cleaners containing ammonia or abrasives. They could remove the graphics from the knob.

## Stainless Steel Parts

All stainless steel parts should be wiped regularly with hot, soapy water at the end of each cooling period and with liquid stainless steel cleaner when soapy water will not do the job. **Do not use** steel wool, abrasive cloths, abrasive cleaners, or powders. If necessary to scrap stainless steel to remove encrusted materials, soak the area with hot towels to loosen the material, then use a wooden or nylon spatula or scraper. **Do not use a metal knife, spatula, or any other metal tool to scrape stainless steel.** For occasional heavy cleaning use, a cleaner such as Liquid Zud can be used according to package directions. Do not permit citrus or tomato juice to remain on stainless steel surface, as citric acid will permanently discolor stainless steel. Wipe up any spills immediately.

## Glass Door Window Surface (Not Glass Ceramic Top)

Clean with detergent and water. Mild glass cleaner will remove fingerprints.

## Broiler Pan and Grid

Clean with detergent and hot water. For stubborn spots, use a soap-filled steel wool pad.

## Brass Parts

**CAUTION:** All brass special ordered parts are coated with an epoxy coating. **DO NOT USE BRASS OR ABRASIVE CLEANERS ON THE BRASS OPTION PARTS.** All brass parts should be wiped regularly with hot soapy water.

## Oven Racks

Clean with detergent and hot water. Stubborn spots can be scoured with a soap-filled steel wool pad. **DO NOT CLEAN THE OVEN RACKS OR RACK SUPPORTS USING THE SELF-CLEAN CYCLE.** They could sustain damage due to the extreme heat of the Self-Clean cycle.

## Self-Clean Cycle

### CAUTION:

Do not touch the exterior portions of the oven after self-cleaning cycle has begun, since some parts become extremely hot to the touch!

During the first few times the self-cleaning feature is used, there may be some odor and smoking from the "curing" of the binder in the high-density insulation used in the oven. When the insulation is thoroughly cured, this odor will disappear. During subsequent self-cleaning cycles, you may sense an odor characteristic of high temperatures.

KEEP THE KITCHEN WELL-VENTED DURING THE SELF-CLEAN CYCLE.

### WARNING:

#### BURN OR ELECTRICAL SHOCK HAZARD

Make sure all control are OFF and oven is COOL before cleaning. Failure to do so can result in burns or electrical shock.

### IMPORTANT

Do not clean, move, wet, or bend door gasket. Poor cleaning and baking may result.

This range features an automatic pyrolytic self-cleaning cycle. During this cycle, the oven reaches elevated temperatures in order to burn off soil and deposits. An integral smoke eliminator helps reduce odors associated with the soil burn-off. A powder ash residue is left in the bottom of the oven after completion of the self-clean cycle. The door latch is automatically activated after selecting the self-clean setting. The latch ensures that the door cannot be opened while the oven interior is at clean temperatures.

**WARNING: Do not use commercial oven cleaners inside the oven. Use of these cleaners can produce hazardous fumes or can damage the porcelain finishes. Do not line the oven with aluminum foil or other materials. These items can melt or burn during a self-clean cycle, causing permanent damage to the oven.**

#### Before starting the Self-Clean cycle:

1. Remove the oven racks, rack supports, and any other items/utensils from the oven. The high heat generated during the cleaning cycle can discolor, warp, and damage these items. Do not use foil or liners in the oven. During the Self-Clean cycle, foil can burn or melt and damage the oven surface.
2. Wipe off any large spills from the oven bottom and sides. Never use oven cleaners inside a self-cleaning oven or on raised portions of the door.
3. Some areas of the oven must be cleaned by hand before the cycle begins. Soil in these areas will be baked on and very difficult to clean if not removed first. Clean the door up to the gasket, the door frame, and up to two inches inside the frame with detergent and hot water. Rinse thoroughly and dry.

#### To start the Self-Clean cycle:

1. Close the oven door completely.
2. Turn the Oven Function selector knob clockwise to the self-clean mode. At this time the clean indicator light will come on.
3. Turn the Temperature Control knob past the clean setting until the knob stops. At this time, the temperature indicator light will come on and within 30 seconds, the automatic door latch engages. The temperature indicator light will remain on until the oven reaches the self-clean temperature and will then cycle on and off during the cycle.

4. The cleaning cycle will last approximately 3 1/2 hours with an additional 30 minutes needed for the oven to cool down enough for the door latch to disengage.
5. When the cycle is completed, turn both the Oven Function selector and the Temperature Control knob to "OFF". At this time the clean indicator light will go off.
6. When the oven has completely cooled, open door and remove any ash from the oven surfaces with a damp cloth.

#### To stop the Self-clean cycle:

To cancel or interrupt the self-cleaning cycle, turn both the Temperature Control knob and Oven Function selector to "OFF". When the oven temperature drops to a safe temperature, the automatic door latch will release and the oven door can be opened.

## Replacing Interior Oven Lights

**CAUTION: DISCONNECT THE ELECTRIC POWER AT THE MAIN FUSE OR CIRCUIT BREAKER BEFORE REPLACING BULB.**

1. Unscrew glass light cover.
2. Use an oven mitt during bulb removal to protect your hand in case the bulb breaks.
3. Replace the bulb with a 120 volt, 40-watt appliance bulb.
4. Replace the light cover
5. Reconnect power at the main fuse or circuit breaker.

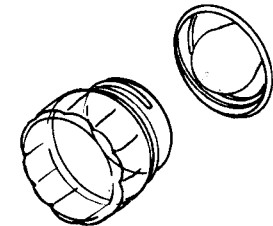

## Power Failure

**Do not attempt to use during a power failure. Unit will not function**

If the range is in the self-clean cycle when the power failure occurs, wait until power is restored and allow door to unlock automatically. Turn all controls off and restart self-clean cycle again, according to instructions.

## Service Information

If service is required after checking the troubleshooting guide:

1. Call your dealer or authorized service agency. The name of the authorized service agency can be obtained from the dealer or distributor in your area.
2. Have the following information readily available:
  - Model Number
  - Serial Number
  - Date of Purchase
  - Name of dealer from whom purchased
3. Clearly describe the problem that you are having.

If you are unable to obtain the name of an authorized service agency, or if you continue to have service problems, contact Viking Range Corporation at (888) 845-4641 or write to:

**VIKING RANGE CORPORATION  
PREFERRED SERVICE**

111 Front Street  
Greenwood, Mississippi 38930 USA

Record the following information indicated below. You will need it if service is ever required. The serial number and model number for your refrigerator is located on the left wall of the the refrigerator section.

Model Number \_\_\_\_\_ Serial Number \_\_\_\_\_

Date of Purchase \_\_\_\_\_ Date Installed \_\_\_\_\_

Dealer's Name \_\_\_\_\_

Address \_\_\_\_\_

---

If service requires installation of parts, use only authorized parts.

**Please retain the manual for future reference**