

SONY®

Cyber-shot

Digital Still Camera Instruction Manual

DSC-S500



Before operating the unit, please read this manual and “Cyber-shot Handbook” (PDF) on CD-ROM (supplied) thoroughly, and retain it for future reference.

Owner's Record

The model and serial numbers are located on the bottom. Record the serial number in the space provided below. Refer to these numbers whenever you call upon your Sony dealer regarding this product.

Model No. DSC-S500

Serial No. _____

Additional information on this product and answers to frequently asked questions can be found at our Customer Support Website.

<http://www.sony.net/>

Preparation

Shoot images easily
(Auto adjustment mode)

View/delete images

Printing images

Troubleshooting

Others

Trademarks

- **Cyber-shot** is trademarks of Sony Corporation.
- “Memory Stick”,  “Memory Stick PRO”, **MEMORY STICK PRO**, “Memory Stick Duo”, **MEMORY STICK DUO**, “Memory Stick PRO Duo”, **MEMORY STICK PRO DUO**, “MagicGate”, and **MAGIC GATE** are trademarks of Sony Corporation.
- Microsoft, Windows and DirectX are either registered trademarks or trademarks of Microsoft Corporation in the United States and/or other countries.
- Macintosh and Mac OS are trademarks or registered trademarks of Apple Computer, Inc.
- Intel, MMX, and Pentium are trademarks or registered trademarks of Intel Corporation.
- In addition, system and product names used in this manual are, in general, trademarks or registered trademarks of their respective developers or manufacturers. However, the TM or ® marks are not used in all cases in this manual.

WARNING

To reduce fire or shock hazard, do not expose the unit to rain or moisture.

For Customers in the U.S.A.

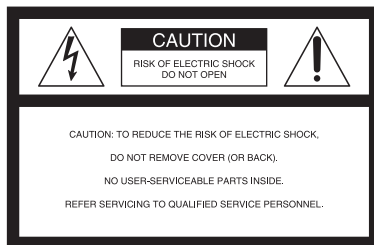

This symbol is intended to alert the user to the presence of uninsulated “dangerous voltage” within the product’s enclosure that may be of sufficient magnitude to constitute a risk of electric shock to persons.



This symbol is intended to alert the user to the presence of important operating and maintenance (servicing) instructions in the literature accompanying the appliance.

IMPORTANT SAFEGUARDS

For your protection, please read these safety instructions completely before operating the appliance, and keep this manual for future reference.

Carefully observe all warnings, precautions and instructions on the appliance, or the one described in the operating instructions and adhere to them.

Use

Power Sources

This set should be operated only from the type of power source indicated on the marking label. If you are not sure of the type of electrical power supplied to your home, consult your dealer or local power company. For those sets designed to operate from battery power, or other sources, refer to the operating instructions.

Polarization

This set may be equipped with a polarized ac power cord plug (a plug having one blade wider than the other).

This plug will fit into the power outlet only one way. This is a safety feature. If you are unable to insert the plug fully into the outlet, try reversing the plug. If the plug should still fail to fit, contact your electrician to have a suitable outlet installed. Do not defeat the safety purpose of the polarized plug by forcing it in.

Overloading

Do not overload wall outlets, extension cords or convenience receptacles beyond their capacity, since this can result in fire or electric shock.

Object and Liquid Entry

Never push objects of any kind into the set through openings as they may touch dangerous voltage points or short out parts that could result in a fire or electric shock. Never spill liquid of any kind on the set.

Attachments

Do not use attachments not recommended by the manufacturer, as they may cause hazards.

Cleaning

Unplug the set from the wall outlet before cleaning or polishing it. Do not use liquid cleaners or aerosol cleaners. Use a cloth lightly dampened with water for cleaning the exterior of the set.

Installation

Water and Moisture

Do not use power-line operated sets near water – for example, near a bathtub, washbowl, kitchen sink, or laundry tub, in a wet basement, or near a swimming pool, etc.

Power-Cord Protection

Route the power cord so that it is not likely to be walked on or pinched by items placed upon or against them, paying particular attention to the plugs, receptacles, and the point where the cord exits from the appliance.

Accessories

Do not place the set on an unstable cart, stand, tripod, bracket, or table. The set may fall, causing serious injury to a child or an adult, and serious damage to the set. Use only a cart, stand, tripod, bracket, or table recommended by the manufacturer.

Ventilation

The slots and openings in the cabinet are provided for necessary ventilation. To ensure reliable operation of the set, and to protect it from overheating, these slots and openings must never be blocked or covered.

- Never cover the slots and openings with a cloth or other materials.
- Never block the slots and openings by placing the set on a bed, sofa, rug, or other similar surface.
- Never place the set in a confined space, such as a bookcase, or built-in cabinet, unless proper ventilation is provided.
- Do not place the set near or over a radiator or heat register, or where it is exposed to direct sunlight.

Lightning

For added protection for this set during a lightning storm, or when it is left unattended and unused for long periods of time, unplug it from the wall outlet and disconnect the antenna or cable system. This will prevent damage to the set due to lightning and power-line surges.

Service

Damage Requiring Service

Unplug the set from the wall outlet and refer servicing to qualified service personnel under the following conditions:

- When the power cord or plug is damaged or frayed.
- If liquid has been spilled or objects have fallen into the set.
- If the set has been exposed to rain or water.
- If the set has been subject to excessive shock by being dropped, or the cabinet has been damaged.
- If the set does not operate normally when following the operating instructions. Adjust only those controls that are specified in the operating instructions. Improper adjustment of other controls may result in damage and will often require extensive work by a qualified technician to restore the set to normal operation.
- When the set exhibits a distinct change in performance – this indicates a need for service.

Servicing

Do not attempt to service the set yourself as opening or removing covers may expose you to dangerous voltage or other hazards.

Refer all servicing to qualified service personnel.

Replacement parts

When replacement parts are required, be sure the service technician has used replacement parts specified by the manufacturer that have the same characteristics as the original parts.

Unauthorized substitutions may result in fire, electric shock, or other hazards.

Safety Check

Upon completion of any service or repairs to the set, ask the service technician to perform routine safety checks (as specified by the manufacturer) to determine that the set is in safe operating condition.

Read this first

For Customers in the U.S.A.

This device complies with part 15 of the FCC rules. Operation is subject to the following two conditions: (1) This device may not cause harmful interference, and (2) This device must accept any interference received, including interference that may cause undesired operation.

CAUTION

You are cautioned that any changes or modifications not expressly approved in this manual could void your authority to operate this equipment.

Note:

This equipment has been tested and found to comply with the limits for a Class B digital device, pursuant to Part 15 of the FCC Rules.

These limits are designed to provide reasonable protection against harmful interference in a residential installation. This equipment generates, uses, and can radiate radio frequency energy and, if not installed and used in accordance with the instructions, may cause harmful interference to radio communications. However, there is no guarantee that interference will not occur in a particular installation. If this equipment does cause harmful interference to radio or television reception, which can be determined by turning the equipment off and on, the user is encouraged to try to correct the interference by one or more of the following measures:

- Reorient or relocate the receiving antenna.
- Increase the separation between the equipment and receiver.
- Connect the equipment into an outlet on a circuit different from that to which the receiver is connected.
- Consult the dealer or an experienced radio/TV technician for help.

The supplied interface cable must be used with the equipment in order to comply with the limits for a digital device pursuant to Subpart B of Part 15 of FCC Rules.

For Customers in Europe

This product has been tested and found compliant with the limits set out in the EMC Directive for using connection cables shorter than 3 meters (9.8 feet).

Attention

The electromagnetic fields at the specific frequencies may influence the picture and sound of this camera.

Notice

If static electricity or electromagnetism causes data transfer to discontinue midway (fail), restart the application or disconnect and connect the communication cable (USB, etc.) again.

Disposal of Old Electrical & Electronic Equipment (Applicable in the European Union and other European countries with separate collection systems)



This symbol on the product or on its packaging indicates that this product shall not be treated as household waste. Instead it shall be handed over to the applicable collection point for the recycling of electrical and electronic equipment. By ensuring this product is disposed of correctly, you will help prevent potential negative consequences for the environment and human health, which could otherwise be caused by inappropriate waste handling of this product. The recycling of materials will help to conserve natural resources. For more detailed information about recycling of this product, please contact your local Civic Office, your household waste disposal service or the shop where you purchased the product.

Notes on using your camera

Types of “Memory Stick” that can be used (not supplied)

The IC recording medium used by this camera is a “Memory Stick Duo”. There are two types of “Memory Stick”.

“Memory Stick Duo”: you can use a “Memory Stick Duo” with your camera.



“Memory Stick”: you cannot use a “Memory Stick” with your camera.



Other memory cards cannot be used.

When using a “Memory Stick Duo” with “Memory Stick” compatible equipment

You can use the “Memory Stick Duo” by inserting it into the Memory Stick Duo Adaptor (not supplied).



Memory Stick Duo Adaptor

No compensation for contents of the recording

- The contents of the recording cannot be compensated for if recording or playback is not possible due to a malfunction of your camera or recording media, etc.

Internal memory and “Memory Stick Duo” back up

- Do not turn off the camera or remove the batteries or “Memory Stick Duo” while the access lamp is lighted, as the internal memory data or “Memory Stick Duo” data may be destroyed. Always protect your data by making a back up copy.

Notes on recording/playback

- This camera is neither dust-proof, nor splash-proof, nor water-proof.
- Before you record one-time events, make a trial recording to make sure that the camera is working correctly.
- Be careful not to get the camera wet. Water entering the inside of the camera may cause malfunctions which in some cases may not be repairable.
- Do not aim the camera at the sun or other bright light. Or it may cause the malfunction of your camera.
- Do not use the camera near a location that generates strong radio waves or emits radiation. The camera may not be able to record or play back properly.
- Using the camera in sandy or dusty locations may cause malfunctions.
- If moisture condensation occurs, remove it before using the camera (page 8).
- Do not shake or strike the camera. In addition to malfunctions and an inability to record images, this may render the recording medium unusable, or cause image data breakdown, damage or loss.
- Clean the flash surface before use. The heat of flash emission may cause dirt on the flash surface to become discolored or to stick to the flash surface, resulting in insufficient light emission.

Notes on the LCD screen and lens

- The LCD screen is manufactured using extremely high-precision technology so over 99.4% of the pixels are operational for effective use. However, there may be some tiny black points and/or bright points (white, red, blue or green in color) that constantly appear on the LCD screen. These points are normal in the manufacturing process and do not affect the recording in any way.



Black, white, red,
blue and green
points

- Exposing the LCD screen or the lens to direct sunlight for long periods may cause malfunctions. Be careful when placing the camera near a window or outdoors.
- Do not press against the LCD screen. The screen may be discolored and that may cause a malfunction.
- Images may trail across on the LCD screen in a cold location. This is not a malfunction.
- This camera is equipped with a power zoom lens. Be careful not to bump the lens, and be careful not to apply force to it.

On image data compatibility

- This camera conforms with DCF (Design rule for Camera File system) universal standard established by JEITA (Japan Electronics and Information Technology Industries Association).
- Playback of images recorded with your camera on other equipment and playback of images recorded or edited with other equipment on your camera are not guaranteed.

Warning on copyright

Television programs, films, videotapes, and other materials may be copyrighted. Unauthorized recording of such materials may be contrary to the provisions of the copyright laws.

The pictures used in this manual

The photographs used as examples of pictures in this manual are reproduced images, and are not actual images shot using this camera.

Do not use/store the camera in the following places

- In an extremely hot, dry or humid place
In places such as in a car parked in the sun, the camera body may become deformed and this may cause a malfunction.
- Under direct sunlight or near a heater
The camera body may become discolored or deformed, and this may cause a malfunction.
- In a location subject to rocking vibration
- Near strong magnetic place
- In sandy or dusty places
Be careful not to let sand or dust get into the camera. This may cause the camera to malfunction, and in some cases this malfunction cannot be repaired.

On cleaning

Cleaning the LCD screen

Wipe the screen surface with an LCD cleaning kit (not supplied) to remove fingerprints, dust, etc.

Cleaning the lens

Wipe the lens with a soft cloth to remove fingerprints, dust, etc.

Cleaning the camera surface

Clean the camera surface with a soft cloth slightly moistened with water, then wipe the surface with a dry cloth. Do not use the following as they may damage the finish or the casing.

- Chemical products such as thinner, benzene, alcohol, disposable cloths, insect repellent, sunscreen or insecticide, etc.
- Do not touch the camera with the above on your hand.
- Do not leave the camera in contact with rubber or vinyl for a long time.

On operating temperatures

Your camera is designed for use under the temperatures between 0°C and 40°C (32°F and 104°F). (In case of alkaline batteries/Oxy Nickel Primary Battery, the temperatures are between 5°C and 40°C (41°F and 104°F).) Shooting in extremely cold or hot places that exceed this range is not recommended.

On moisture condensation

If the camera is brought directly from a cold to a warm location, moisture may condense inside or outside the camera. This moisture condensation may cause a malfunction of the camera.

Moisture condensation occurs easily when:

- The camera is brought from a cold location such as a ski slope into a warmly heated room.
- The camera is taken from an air-conditioned room or car interior to the hot outdoors, etc.

How to prevent moisture condensation

When bringing the camera from a cold place to a warm place, seal the camera in a plastic bag and allow it to adapt to conditions at the new location over about an hour.

If moisture condensation occurs

Turn off the camera and wait about an hour for the moisture to evaporate. Note that if you attempt to shoot with moisture remaining inside the lens, you will be unable to record clear images.

On the internal rechargeable battery

This camera has an internal rechargeable battery for maintaining the date and time and other settings regardless of whether the power is on or off.

This rechargeable battery is continually charged as long as you are using the camera. However, if you use the camera for only short periods, it discharges gradually, and if you do not use the camera at all for about one week it becomes completely discharged. In this case, be sure to charge this rechargeable battery before using the camera.

However, even if this rechargeable battery is not charged, you can still use the camera as long as you do not record the date and time.

Charging method of the internal rechargeable battery

Insert batteries with enough capacity in the camera, and leave the camera for 24 hours or more with the power off.

Table of contents

Read this first	5
Notes on using your camera	6

Preparation 10

Check the accessories (supplied)	10
Insert the batteries	10
Insert a "Memory Stick Duo" (not supplied).....	12
Getting started.....	13

Shoot images easily (Auto adjustment mode) 15

View/delete images 18

Printing images 20

Troubleshooting 22

Others 25

Supported Operating Systems for USB connection and application software (supplied)	25
Viewing "Cyber-shot Handbook"	25
Specifications	26
Identifying parts	27
Indicators on the screen	Back cover

Enjoying additional functions on recording/playback using the menu

Selecting the desired setting

Making use of a PC and printer

Problems during operation



Refer to "Cyber-shot Handbook" (PDF).



Check the accessories (supplied)

Accessories (supplied) list

- LR6 (size AA) alkaline batteries (2)
- A/V cable (1)
- USB cable (1)
- Wrist strap (1)
- CD-ROM (Cyber-shot application software, handbook “Cyber-shot Handbook”) (1)
- Operating instructions for digital still camera “Instruction Manual” (this manual) (1)

Attach the wrist strap

The camera is a precision instrument. Be careful not to bump the lens or the LCD screen, and not to apply force to it. Attach the strap to prevent the camera from damage by being dropped, etc.

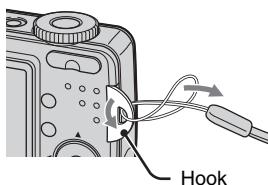

Insert the batteries

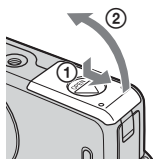

While pressing OPEN, open the battery/“Memory Stick Duo” cover.

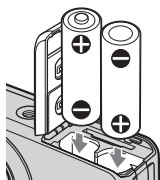

Match +/- and insert.

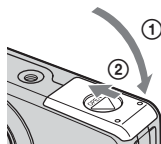

Close the battery/“Memory Stick Duo” cover.

To remove the batteries

Hold the camera with the battery/“Memory Stick Duo” cover facing upward, then open the battery/“Memory Stick Duo” cover and remove the batteries. Be careful not to drop the batteries.

Batteries you can and cannot use with your camera

Battery type	supplied	supported	rechargeable
LR6 (size AA) alkaline batteries	○	○	—
HR 15/51:HR6 (size AA) Nickel-Metal Hydride batteries*	—	○	○
ZR6 (size AA) Oxy Nickel Primary Battery	—	○	—
Manganese batteries**	—	—	—
Lithium batteries**	—	—	—
Ni-Cd batteries**	—	—	—

* NH-AA-2DB twin pack, etc.





**Operating performance cannot be ensured if voltage drops or other problems are caused by the nature of the battery.

WARNING

Battery may explode or leak if mistreated. Do not recharge, disassemble or dispose of in fire. Check the valid date (month-year) displayed on the batteries.

To check the remaining battery time

Press POWER to turn on and check the time on the LCD screen.

Battery remaining indicator					
Battery remaining guidelines	Sufficient power remaining	Battery half full	Battery low, recording/playback will stop soon.	Replace the batteries with new ones.	The warning indicator flashes.

- The displayed time remaining may not be correct under certain circumstances.
- When using alkaline batteries/Oxy Nickel Primary Battery, the battery remaining indicator may not display the correct information.

Battery life and number of images that can be recorded (When shooting still images)

Battery	No. of images (Approx.)	Battery life (min.) (Approx.)
Alkaline	60	30
NH-AA-DB (Ni-MH)	350	170

- The measurement method is based on the CIPA standard. (CIPA: Camera & Imaging Products Association)

- The values shown for alkaline battery are based on commercial norms, and do not apply to all alkaline batteries in all conditions. The values may vary, depending on the battery manufacturer/type, environmental conditions, product setting, etc.
- The alkaline battery (supplied) is for trial use only. You may need to purchase an additional battery for regular camera use.

Insert a “Memory Stick Duo” (not supplied)

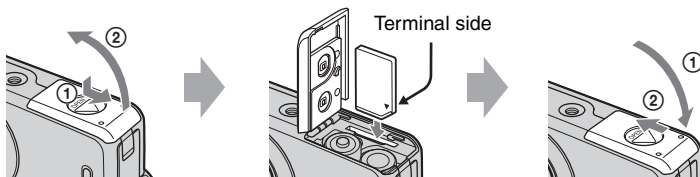

Insert the “Memory Stick Duo” all the way in until it clicks.

To remove a “Memory Stick Duo”

Open the battery/“Memory Stick Duo” cover, then push the “Memory Stick Duo” in once.

When the access lamp is lit

Never open the battery/“Memory Stick Duo” cover or turn off the power as data may be corrupted.

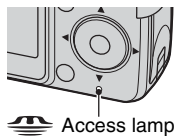

Access lamp

The camera has approx. 25 MB of internal memory. However, purchase of a “Memory Stick Duo” is recommended. Only “Memory Stick Duo” can be used.

The table below shows the approximate total number of still images and approximate movie recording time that can be recorded on the various capacities of “Memory Stick Duo,” for reference before purchasing.

Total number of still images (Image quality is [Fine].)

(Units: Images)

Capacity	Internal memory	64MB	128MB	256MB	512MB
6M	7	21	42	77	157
3:2	7	21	42	77	157
3M	15	41	82	148	302
2M	25	66	133	238	484
VGA (E-Mail)	152	394	790	1428	2904

Movie recording time

(Units: hour : minute : second)

Size \ Capacity	Internal memory	64MB	128MB	256MB	512MB
320 × 240	0:01:20	0:03:20	0:06:40	0:12:50	0:25:20

Getting started

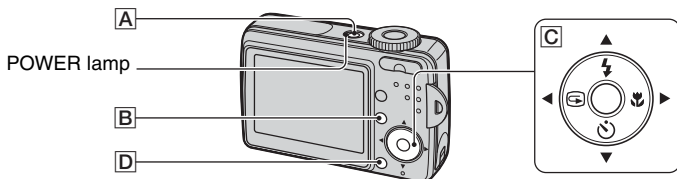

Turn the power on/off











To turn on, press POWER ([A]). The POWER lamp lights up.

To turn off, press POWER again. The POWER lamp goes out.

- When turning on the power, do not touch the lens portion as the cover opens and the lens portion extends. Also, do not leave the camera with the lens portion extended for a long period of time with the power off as this may cause a malfunction.
- If the camera is running on battery power and you do not operate the camera about three minutes, the camera turns off automatically to prevent battery drain (Auto power-off function).

Set/Change the date and time

First, enter the  (Setup) menu to select [Clock Set].

- 1 Press MENU ([B]) to display the menu.
- 2 After pressing  on the control button ([C]), go to the  (Setup) setting, then press  again.
- 3 Select  (Setup2) with , then press .
- 4 Select [Clock Set] with , then press .
- 5 Select [OK] with , then press .

Now you can adjust the date and time.

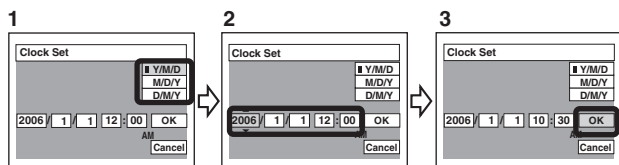

- 1 Select the desired date display format with ▲/▼, then press ●.
 - 2 Select each item with ◀/▶ and set the numeric value with ▲/▼, then press ●.
 - 3 Select [OK] with ▶, then press ●.
- To cancel, select [Cancel] and press ●.



To turn off the (Setup) menu screen

Press MENU.





Change the language setting

Open the  (Setup) screen after performing step ① and ② in “Set/Change the date and time.” Select [Language] in  (Setup1), then choose your desired language.

Select the image size for still images

The factory setting for image size is [6M]. This setting requires more memory capacity, which reduces the number of images you can take. Set the image size according to purpose.

- ① Press  /  (Image Size) (D).
- ② Select the size with ▲/▼ (C).
- ③ Press  /  (Image Size) to complete the setting.

Image size	Guidelines	No. of images	Printing
6M (2816 × 2112) (the default setting)	For printing in A4 size or high density images in A5 size	Less	Fine
3:2 (2816 × 1872)*			
3M (2048 × 1536)		↕	↕
2M (1632 × 1224)	For printing in postcard size	 More	 Rough
VGA (E-Mail) (640 × 480)	For recording a larger number of images For attaching images to e-mail or creating web pages		

* Images are recorded in the same 3:2 aspect ratio as photograph printer paper or postcards, etc.

- Recordable number of still images vary depending on the image size selected.

Shoot images easily (Auto adjustment mode)

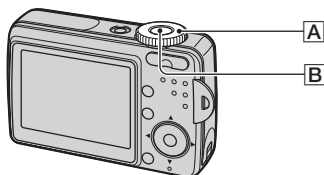

Hold the camera



Position the subject in the center of the focus frame

Hints for preventing blur

Hold the camera steadily, keeping your arms at your side. Also, you can stabilize the camera by leaning against a tree or a building beside you. Using a tripod may be effective. Also, using the flash in dark places is also recommended.

Shoot an image

1 Select a mode (A).

Still image: Select .

Movie: Select .

2 Shoot with the shutter button (B).

Still image:

Press and hold halfway down to focus.

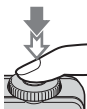

AE/AF lock indicator
Flashing → lit/beeps



Press fully down.
The shutter sounds.

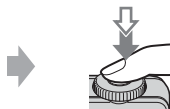

Movie:

Press fully down.



• To stop recording, press the shutter button fully down again.

To shoot an image using the zoom

Press T (telephoto) to zoom in, or W (wide angle) to zoom out when composing your shot.



- You cannot change the zoom scale while shooting a movie.
- When the zoom scale exceeds 3×, the camera uses [Digital Zoom].



To shoot an image using the mode dial

- 1 Set the mode dial to the desired still image shooting mode.
- 2 Shoot with the shutter button.

Auto adjustment mode (📷)

Adjusts settings automatically for easy shooting.

Scene Selection modes (🌙, 👤, 🕯️, 🏖️, 🏔️, 👤)

Allows you to shoot using an appropriate preset setting for a scene.

The following modes are predetermined to match the scene conditions.



Twilight*

Captures the dark surroundings in distant night shots.



Beach

Captures the blue color of water in beach scenes, etc.



Twilight portrait*

For portraits in dark places.



Landscape

For landscapes, etc., with a distant subject.



Candle*

Captures the atmosphere of candlelit scenes.



Soft snap

For soft portraits of people, flowers, etc.

*The shutter speed becomes slower, so using a tripod is recommended.

Program auto shooting mode (P)

Allows you to shoot with automatic exposure (adjusts both shutter speed and aperture). You can also make various settings using the menu.



To shoot an image using the control button

Selecting a flash mode for still images (⚡)

Before you shoot, press ▲ (⚡) on the control button repeatedly until the desired mode is selected.

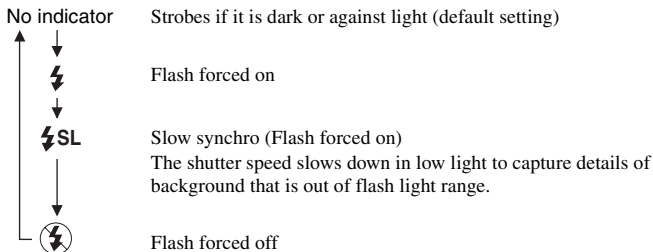

- Flash range (when [ISO] is set to [Auto])
W side: Approx. 0.5 to 2.5 m (19 3/4 to 98 1/2 inches)
T side: Approx. 0.5 to 2.0 m (19 3/4 to 78 3/4 inches)
- The flash strobes twice. The first time is to adjust flash intensity.
- While charging the flash, is displayed.

Shooting close-up (Macro) (🌸)

Before you shoot, press ► (🌸) on the control button.

To cancel, press ► again.

- Setting the zoom all the way to the W side is recommended.
- The in-focus range becomes narrow, and the complete subject may not be entirely in focus.
- The AF speed drops.

Shortest shooting distance from the lens surface

Setting all the way to the W side: Approx. 5 cm (2 inches)

Setting all the way to the T side: Approx. 35 cm (13 7/8 inches)

Using the self-timer (⌚)

Before you shoot, press ▼ (⌚) on the control button repeatedly until the desired mode is selected.

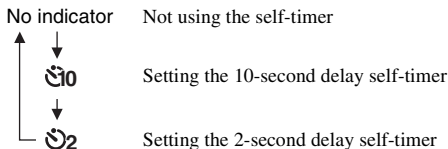

Press the shutter button, the self-timer lamp flashes and a beep sounds until the shutter operates.

To cancel, press ▼ again.

- Use the 2-second delay self-timer to reduce the risk of blur.

View/delete images

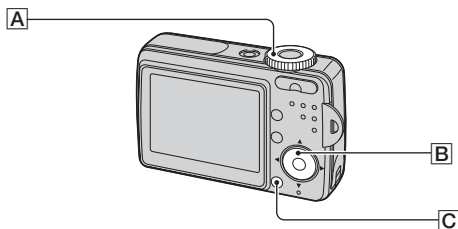

To view images

- 1 Select (A).
- 2 Select an image with (B).
- 3 **Movie only** : Press (B).

Rewind/Fast forward: (Return to normal playback:)

Stop playback:

- Sound is not output during movie playback on this camera. Sound can be heard when viewing a movie on a computer or TV.

To delete images

- 1 Display the image you want to delete and press / (Delete) (C).
- 2 Select [Delete] with , then press (B).

- To cancel the deletion, select [Exit], then press in step 2.



To view an image using the control button (Quick Review)

You can check the last image you took.

Press (⏪) on the control button.

To cancel, press again.

- The image may appear rough right after playback starts.
- To delete an image, press / (Delete) and select [Delete] with on the control button, then press .



To view/delete an image using the zoom button

To view an enlarged image (playback zoom)

While displaying a still image, press to zoom in on the image.

To undo the zoom, press .

Adjust the portion: /▼/◀/▶

Cancel playback zoom: ●

Viewing an index screen

While displaying a still image, press (Index), then select an image with /▼/◀/▶.

To return to the single-image screen, press ●. To display the next (previous) index screen, press ◀/▶.

To delete images in index mode

- 1 While an index screen is displayed, press / and select [Select] with /▼ on the control button, then press ●.
 - 2 Select the image you want to delete with /▼/◀/▶, then press ● to display the (Delete) indicator on the selected image.
 - 3 Press / .
 - 4 Select [OK] with ▶, then press ●.
- To delete all the images in a folder, select [All In This Folder] with /▼ in step 1 instead of [Select], then press ●.
 - To cancel a selection, select an image previously selected for deletion, then press ● to delete the indicator from the image in step 2.

To view images on a TV screen

You can view images on a TV screen by connecting the camera to a TV.

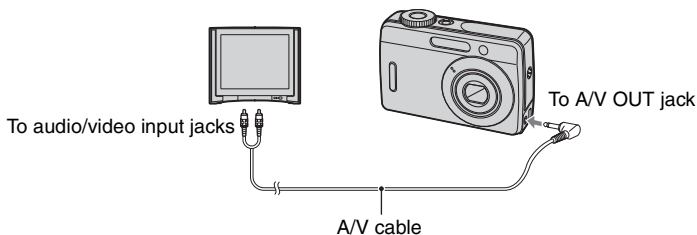

Printing images using a PictBridge compliant printer

Even if you do not have a computer, you can print images shot using your camera by connecting the camera directly to a PictBridge compliant printer.



- “PictBridge” is based on the CIPA standard. (CIPA: Camera & Imaging Products Association)

Notes:



- You cannot print movies.
- If the  indicator flashes on the screen of the camera for about five seconds (error notification), check the connected printer.
- For further details on how to use PictBridge print and how to print images copied onto a computer, refer to “Cyber-shot Handbook”.

Stage 1: Preparing the camera



Prepare the camera to connect it to the printer via a USB connection.

- It is recommended to use batteries with enough capacity to prevent the power from turning off partway through printing.

1 Press MENU to display the menu.

2 Press  on the control button to select  (Setup).

3 Select  (Setup2) with , then select [USB Connect] with //.

4 Select [PictBridge] with /, then press .

The USB mode is set.

Stage 2: Connecting the camera to the printer

1 Connect the camera to the printer.

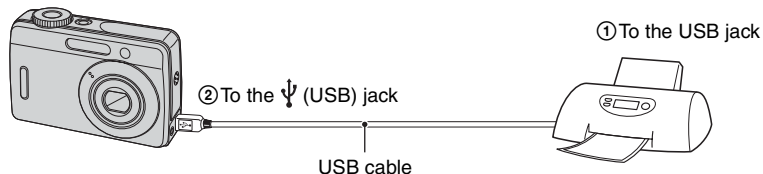

2 Turn on your camera and the printer.

The camera is set to playback mode, then an image and the print menu appear on the screen.

Stage 3: Printing

Regardless of what the mode dial is set to, the print menu appears when you complete Stage 2. The following procedure describes how to print the image appearing on the screen after the USB cable is connected.

1 Select [This image] with ▲/▼ on the control button, then press ●.

2 Select print settings with ▲/▼/◀/▶.

3 Select [OK] with ▼/▶, then press ●.

The image is printed.

- If the  (PictBridge Connecting) icon appears on the screen, do not disconnect the USB cable.

To print other images

Select [Select] in step 1.

Selects images and prints all the selected images.

① Select the image you want to print with ◀/▶, then press ●.



The ✓ mark appears on the selected image.

- To select other images, repeat this procedure.

② Select [Print] with ▼, then press ●.

Troubleshooting

If you experience trouble with your camera, try the following solutions.

- 1 Check the items on pages 22 to 24. Refer to “Troubleshooting” in the “Cyber-shot Handbook” regarding unlisted items on these pages.
- 2 Remove the batteries, and insert the batteries again after about one minute, and turn on the power.
- 3 Initialize the settings. Go to the  (Setup) setting in the MENU, and then select [Initialize] in  (Setup1).
- 4 Consult your Sony dealer or local authorized Sony service facility.

Please understand that you give your consent that the contents of the internal memory may be checked when you send your camera to be repaired.

Batteries and power

The batteries run down too quickly.

- You are using the camera in an extremely cold location.
- The batteries are dead. Replace them with new ones.
- When using the Nickel-Metal Hydride batteries (not supplied), charge them sufficiently.
- When using alkaline batteries/Oxy Nickel Primary Battery (not supplied), the displayed time remaining may not be correctly indicated.

The power turns off suddenly.

- If you do not operate the camera for about three minutes while the power is on, the camera turns off automatically to prevent wearing down the batteries. Turn on the camera again.

Camera power is turned off automatically when you open the battery/“Memory Stick Duo” cover.

- This is not a malfunction. Turn off the camera before you open the battery/“Memory Stick Duo” cover.

Shooting still images

Your camera cannot record images.

- Check the free capacity of the internal memory or “Memory Stick Duo” (page 12). If it is full, do one of the following:
 - Delete unnecessary images.
 - Change the “Memory Stick Duo”.
- You are using the “Memory Stick Duo” with the write-protect switch, and the switch is set to the LOCK position. Set the switch to the recording position.

The image is out of focus.

- The subject is too close. Record in the close-up (Macro) recording mode. Make sure to position the lens farther away from the subject than the shortest shooting distance, approximately 5 cm (2 inches) (W)/35 cm (13 7/8 inches) (T), when shooting.
- ☾ (Twilight mode) or 🌄 (Landscape mode) is selected in the Scene mode when shooting still images.

The flash does not work.

- The flash is set to ⓧ (Flash forced off).
- You cannot use the flash when:
 - [Mode] (REC Mode) is set to [Burst].
 - ☾ (Twilight mode) or 🕯 (Candle mode) is selected in the Scene Selection.
 - When the mode dial is set to 📷.
- Set the flash to ⚡ (Flash forced on) to shoot still images when 🌄 (Landscape mode) or 🏖 (Beach mode) is selected in the Scene Selection.

The close-up (Macro) function does not work.

- ☾ (Twilight mode), 🌄 (Landscape mode) or 🕯 (Candle mode) is selected in the Scene Selection.

The date and time are not displayed.

- While shooting, the date and time are not displayed. Only during playback, the date and time are displayed.

The eyes of the subject come out red.

- Set [Red Eye Reduction] in the 📷 (Setup) menu to [On].
- Shoot the subject at a distance closer than the recommended shooting distance using the flash.
- Light the room and shoot the subject.

Viewing images

Your camera cannot play back images.

- Set the mode dial to  (page 18).
 - The camera is in USB mode. Delete the USB connection.
-

The date and time are not displayed.

- The  (Screen status) button is turned off.
-

The image does not appear on the TV screen.

- Check [Video Out] to see if the video output signal of your camera is set to the color system of your TV.
- Check whether the connection is correct.
- The USB cable is connected to the USB jack.

Supported Operating Systems for USB connection and application software (supplied)

	For Windows users	For Macintosh users
USB connection	Windows Millennium Edition, Windows 2000 Professional, Windows XP Home Edition or Windows XP Professional	Mac OS 9.1, 9.2 or Mac OS X (v10.0 or later)
Application software “Cyber-shot Viewer”	Windows Millennium Edition, Windows 2000 Professional, Windows XP Home Edition or Windows XP Professional	not compatible

- Must be installed with above OS at delivery.
- For further details on the operating environment of “Cyber-shot Viewer,” refer to “Cyber-shot Handbook.”

Viewing “Cyber-shot Handbook”

For Windows users

1 Turn on your computer, and insert the CD-ROM into the CD-ROM drive.

The screen below appears. When you click the [Cyber-shot Handbook] button, the screen for copying “Cyber-shot Handbook” appears. Follow the on-screen instructions to copy.



2 After the installation is complete, double-click “Handbook.pdf.”

For Macintosh users

1 Turn on your computer, and insert the CD-ROM into the CD-ROM drive.

Select the “Handbook” folder and copy “Handbook.pdf” stored in the “GB” folder to your computer.

2 After copying is complete, double-click “Handbook.pdf.”

Specifications

[System]

Image device	7.17 mm (1/2.5 type) color CCD, Primary color filter
Total pixel number of camera	Approx. 6 183 000 pixels
Effective pixel number of camera	Approx. 6 003 000 pixels
Lens	3× zoom lens f = 5.4 – 16.2 mm (32 – 96 mm when converted to a 35 mm still camera) F2.8 – 4.8
Exposure control	Automatic exposure, Scene Selection (6 modes)
White balance	Automatic, Daylight, Cloudy, Fluorescent, Incandescent
File format (DCF compliant)	Still images: Exif Ver. 2.21 JPEG compliant, DPOF compatible Movies: AVI (Motion JPEG)
Recording media	Internal Memory (Approx. 25 MB) “Memory Stick Duo” (with MagicGate/ without MagicGate) “Memory Stick PRO Duo” “MagicGate Memory Stick Duo”
Flash range	When ISO set to Auto: approx. 0.5 m to 2.5 m (19 3/4 inches to 98 1/2 inches) (W)/ approx. 0.5 m to 2.0 m (19 3/4 inches to 78 3/4 inches) (T)

[Input and Output connectors]

A/V OUT jack	Mini-jack Video signal: 1 Vp-p, 75 Ω (ohms), unbalanced, sync negative Audio signal: 2 V (at load impedance more than 47 kΩ (kilohms)) Output impedance with less than 2.2 kΩ (kilohms)
USB jack	mini-B
USB communication	Full-Speed USB (USB 2.0 compliant)

[LCD screen]

LCD panel	6.0 cm (2.4 type) TFT drive
Total number of dots	110 000 (480 × 234) dots

[Power, general]

Power	LR6 (size AA) Alkaline batteries (2), 3 V HR15/51:HR6 (size AA) Nickel-Metal Hydride batteries (2) (not supplied), 2.4 V ZR6 (size AA) Oxy Nickel Primary Battery (2) (not supplied), 3 V AC-LS5K AC Adaptor (not supplied), 4.2 V
Power consumption (during shooting with the LCD screen on)	1.6 W
Operating temperature	0 to 40°C (32 to 104°F)
Storage temperature	-20 to +60°C (-4 to +140°F)
Dimensions	92 × 62 × 31 mm (3 3/4 inches × 2 1/2 inches × 1 1/4 inches) (W/H/D, excluding protrusions)
Mass	Approx. 198 g (7.0 oz) (including two batteries and wrist strap, etc.)
Microphone	Electret condenser microphone
Buzzer	Piezo-electric buzzer
Exif Print	Compatible
PRINT Image Matching III	Compatible
PictBridge	Compatible

Design and specifications are subject to change without notice.

Identifying parts

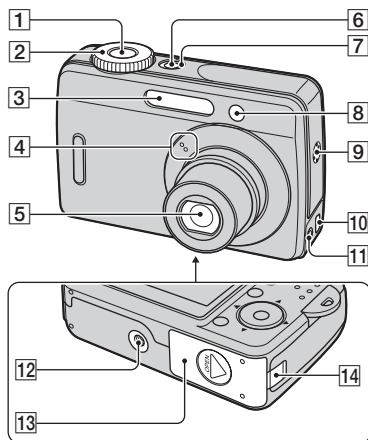

1 Shutter button (15)

2 Mode dial

: To shoot movies

: To view or edit images

- For details on modes available to shoot still images, see “To shoot an image using the mode dial” (page 16).

3 Flash (17)

4 Microphone

5 Lens

6 POWER button (13)

7 POWER lamp (13)

8 Self-timer lamp (17)

9 Buzzer

10 (USB) jack (21)

11 A/V OUT jack (19)

12 Tripod receptacle

- Use a tripod with a screw length of less than 5.5 mm (7/32 inch). You will be unable to firmly secure the camera to tripods having screws longer than 5.5 mm (7/32 inch), and may damage the camera.

13 Battery/“Memory Stick Duo” cover (10)

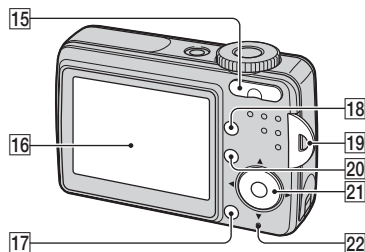

14 AC Adaptor cord cover

15 For shooting: Zoom (W/T) button (16)

For viewing: (Playback zoom) button (19)/ (Index) button (19)

16 LCD screen (7)

17 (Image Size/Delete) button (14, 18)

18 (Screen status) button

19 Hook for wrist strap (10)

20 MENU button (13)

21 Control button (13, 17, 18)

Menu on:

Menu off:

22 Access lamp (12)

Indicators on the screen

When shooting still images (Auto adjustment mode)

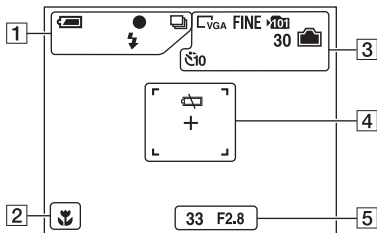

When shooting movies (Factory setting)

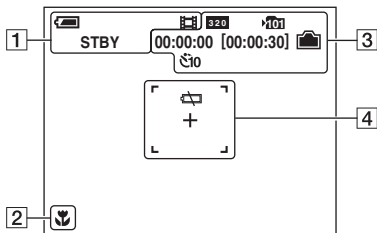

1

Display	Indication
	Battery remaining
	AE/AF lock
	Recording mode
STBY REC	Standby/Recording a movie
	Flash mode
	Flash charging

2

Display	Indication
	Macro

3

Display	Indication
	Image size
FINE	Image quality
	Recording folder • This does not appear when using internal memory.
	Remaining internal memory capacity
	Remaining "Memory Stick" capacity
00:00:00 [00:00:30]	Recording time [maximum recordable time]
30	Remaining number of recordable images
	Self-timer

4

Display	Indication
	Low battery warning
	AF range finder frame

5

Display	Indication
33	Shutter speed
F2.8	Aperture value
	Menu (not displayed on the screen shown above)